

Faucet.



For all your needs in superior faucets...
The most comprehensive range of
faucet from formula gives you flexible choice.

Classical Faucet
Modern Faucet

40年來，方程式衛浴累積了豐富的製造經驗，將高品質呈現在每一件成品上，兼具功能與設計感，並依照客戶需求，給予特殊客製化產品，讓無限的想法與創意，展現在每個不凡的空間中。

對我們來說，水龍頭不只是家居中的必要元素之一，而是一種追求美與自我的生活呈現。使用方程式水龍頭，不再是使用它，而是享受它與享受生活氛圍帶來的幸福與滿足。它是水龍頭，它是精品，它是一種氛圍的感受。

Bay Yang Enterprise Co., Ltd. is a faucet manufacturer based in Taiwan. We specialize in manufacturing high-end and deluxe kitchen and bathroom faucets as brand name Formula. Comprehensive and tailor-made kitchen & bath faucets are sophisticatedly provided with over 40 years experiences.

With years of market experiences and the expertise in kitchen and bathroom faucets development, Formula Faucet has successfully launched several signature products. Considering timeless and trendy, we have created a series of products that are functional, durable and old world charm to perfectly fit any interior decoration proposals.



industriell

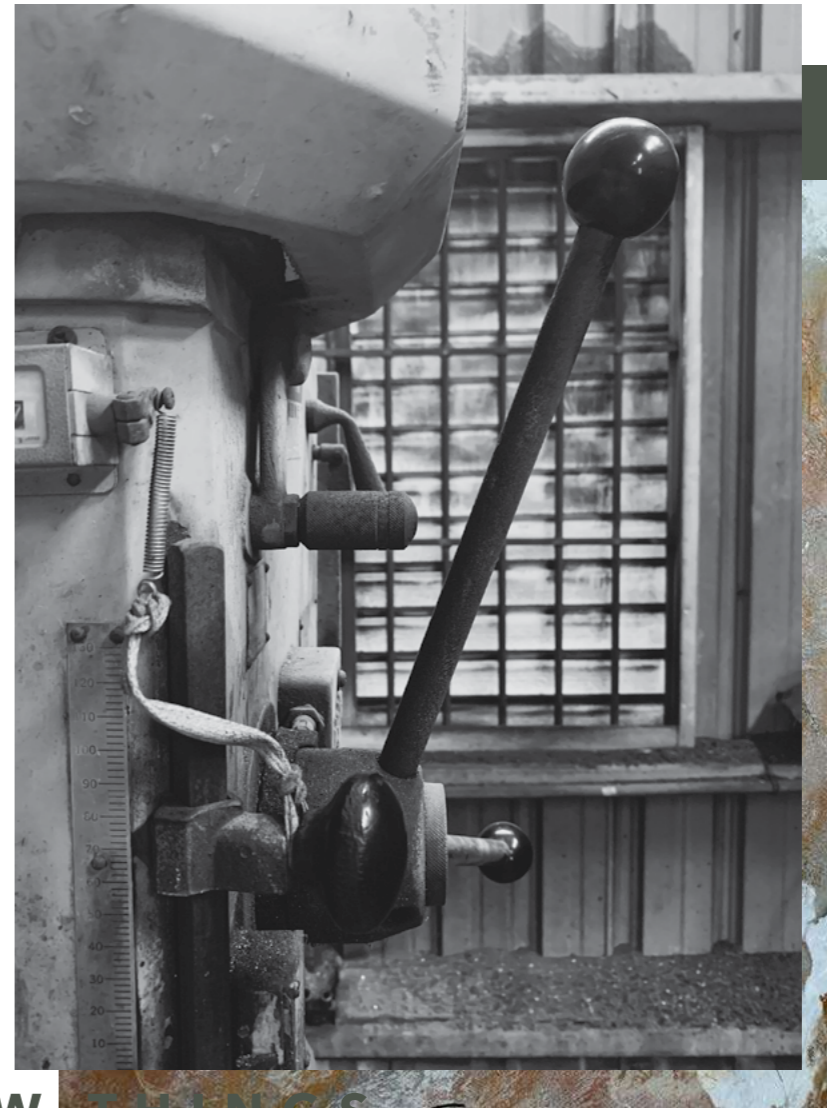

NEW THINGS

工業風水龍頭

ACHIVEMENTS



**泡沫式起泡器
NEOPERL AERATOR**

瑞士 Neoperl 省水起泡器，柔細出水增添舒適感受。

表面測試 COATING TEST

均通過抗腐蝕 CASS 鹽霧測試、附著力測試、水浸測試、抗化學測試、耐磨度以及硬度等表面測試。

**無鉛銅原料
LEAD-FREE BRASS MATERIAL**

使用環保銅原料，符合國際標準含鉛低於 0.25% 限制。

設計 DESIGN

結合全鍛造技術打造粗獷卻典雅工業風格，利用大小不一銅管與設計彎頭構造彼此緊密聯繫，呈現堅實牢固感，搭載細節滾花與六角型開關把手，為衛浴空間注入不同氛圍。

**國際認證
INTERNATIONAL CERTIFICATION**

通過北美 CSA, NSF61-9, NSF372, WaterSense, CEC, 台灣 LF 飲用水與省水標章等多項國內外認證。

**Industriell
Collection**

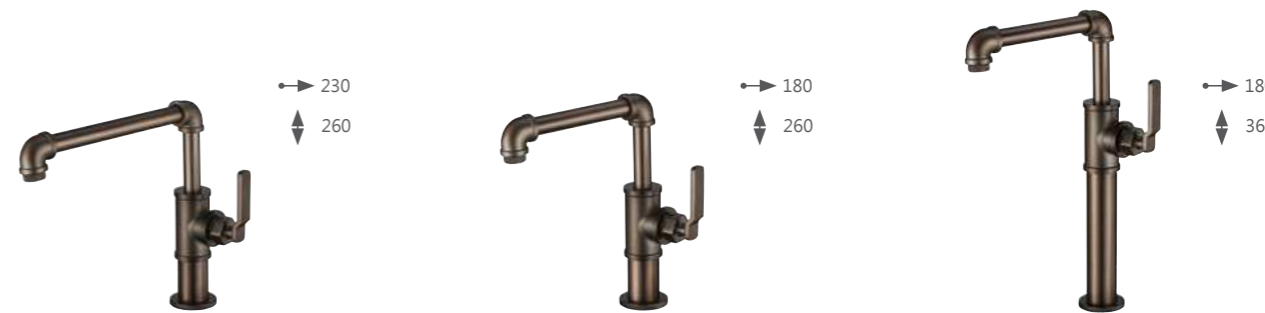

A-8744 ORB
廚房龍頭
Kitchen Faucet

A-8745 ORB
面盆龍頭
Basin Faucet

A-8746 ORB
加高面盆龍頭
Basin Faucet



A-8754 MB
廚房龍頭
Kitchen Faucet

A-8755 MB
面盆龍頭
Basin Faucet

A-8756 MB
加高面盆龍頭
Basin Faucet



A-8742 ORB
面盆龍頭 (分離式)
Basin Faucet

A-8742-3 ORB
浴缸龍頭
Tub Faucet

顏色選擇：

ORB 油棕色

MB 啞光黑色



→ Spout Reach 中心點至出水口距離 Total Height 總高 → Faucet Center 冷熱進水距離 Unit 單位 mm



A-220-1
嵌牆浴缸龍頭
Concealed Wall Mount
Tub Faucet



A-220-1A
嵌牆浴缸龍頭
Concealed Wall Mount
Tub Faucet



A-220-1B
嵌牆浴缸龍頭
Concealed Wall Mount
Tub Faucet



A-618 MB
廚房龍頭
Kitchen Faucet



A-8743-4 ORB
廚房龍頭 (附噴槍)
Kitchen Faucet w/ Spray



A-8744-2 ORB
廚房龍頭 (附噴槍)
Kitchen Faucet w/ Spray



A-8597 ORB
嵌牆面盆龍頭
Concealed Wall Mount
Basin Faucet



A-8757 ORB
嵌牆面盆龍頭
Concealed Wall Mount
Basin Faucet



A-8747 ORB
嵌牆面盆龍頭
Concealed Wall Mount
Basin Faucet

→ Spout Reach 中心點至出水口距離 ↕ Total Height 總高 → Plate Width 主體面板寬 Unit 單位 mm



A-8736 MB
面盆龍頭
Basin Faucet



A-8734 MB
廚房龍頭
Kitchen Faucet



A-8731 MB
沐浴龍頭
Shower Faucet



A-8740 MB
沐浴龍頭
Shower Faucet



A-616 MB
單冷長柱
Pillar Tap



A-617 MB
單冷立柱
Bar Faucet

→ Spout Reach 中心點至出水口距離 ↕ Total Height 總高 → Faucet Center 冷熱進水距離 Unit 單位 mm



顏色選擇：

MB 啞光黑色

CP 鍍鉻色



Harmoniously
Integrated
Into The Design



A-2780
大花灑龍頭
Shower Set



A-8610
沐浴龍頭
Shower Faucet

A-8611
沐浴龍頭
Shower Faucet

A-8715
面盆龍頭
Basin Faucet

A-8622
面盆龍頭 (分離式)
Basin Faucet



A-8622-3 (三件式)
A-8622-5 (五件式)
浴缸龍頭
3/5- Hole tub Faucet

A-8552 (分離式)
A-8552N 無鉛銅
面盆龍頭
Basin Faucet

A-8552-3 (三件式)
A-8552-5 (五件式)
浴缸龍頭
3/5- Hole Tub Faucet

A-8552-3BN
浴缸龍頭
Tub Faucet
Brushed Nickel

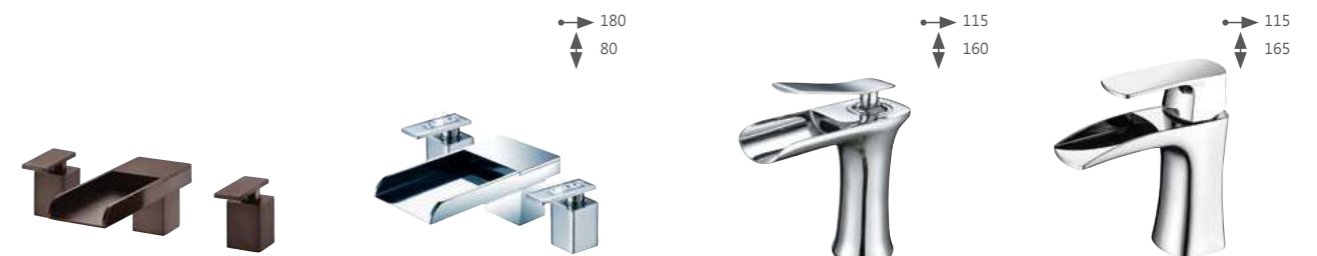

A-8552-3ORB
浴缸龍頭
Tub Faucet
Oil Rubbed Bronze

A-8552-3CZ (三件式)
A-8552-5CZ (五件式)
浴缸龍頭
3/5- Hole Tub Faucet

A-8652
面盆龍頭
Basin Faucet

A-8645
面盆龍頭
Basin Faucet

→ Spout Reach 中心點至出水口距離 ↑ Total Height 總高 → Faucet Center 冷熱進水距離 Unit 單位 mm

Enjoy personal spaces that offers a new sense of well-being and a daily wellness experience



A-8730
沐浴龍頭 (玫瑰金)
Shower Faucet
Rose Gold

→ 190
→ 150

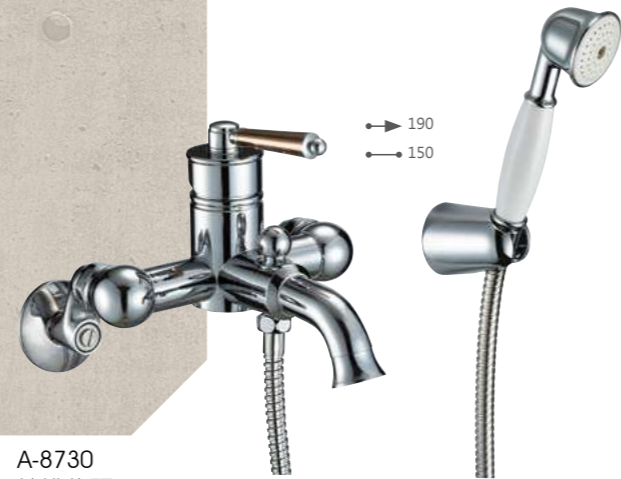

A-8730
沐浴龍頭
Shower Faucet

→ 190
→ 150



A-8735
面盆龍頭 (玫瑰金)
Basin Faucet
Rose Gold

→ 125
↑ 155

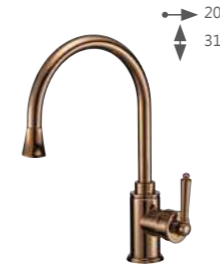

A-8724
廚房龍頭 (玫瑰金)
Kitchen Faucet
Rose Gold

→ 200
↑ 315



A-8732-3
浴缸龍頭 (玫瑰金)
3-Hole Tub Faucet
Rose Gold

→ 200
↑ 280



A-8735
A-8735N 無鉛銅
面盆龍頭
Basin Faucet Lead Free

→ 125
↑ 155



A-205
A-205N 無鉛銅
面盆龍頭
Basin Faucet Lead Free

→ 125
↑ 145



A-295
面盆龍頭 Basin Faucet
A-275 加高 16cm

→ 115
↑ 145



A-206
面盆龍頭附蓮蓬頭
Basin Faucet
w / Handshower

→ 155
↑ 140



A-260
沐浴龍頭
Shower Faucet

→ 210
→ 150



A-225
面盆龍頭
Basin Faucet

→ 125
↑ 310



A-205A
A-205AN 無鉛銅
面盆龍頭
Basin Faucet Lead Free

→ 125
↑ 150



A-295A
面盆龍頭
Basin Faucet

→ 115
↑ 318



A-275A
面盆龍頭
Basin Faucet

→ Spout Reach 中心點至出水口距離 ↑ Total Height 總高 → Faucet Center 冷熱進水距離 Unit 單位 mm



A-204
廚房龍頭
Kitchen Faucet

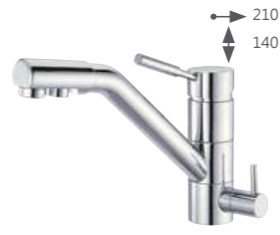

A-214
廚房龍頭附 RO 開關
Kitchen Faucet
w/ RO Diverter



A-265
面盆龍頭 Basin Faucet
A-266
A-266N 無鉛銅
A-266-1 加高 7cm
廚房龍頭
Kitchen Faucet Lead Free



A-8535
面盆龍頭 Basin Faucet
A-8535-1 加高 7cm
A-8536
廚房龍頭 Kitchen Faucet
專利品 Patented



A-8651
面盆龍頭
Basin Faucet



A-8570
面盆龍頭 (分離式)
Basin Faucet

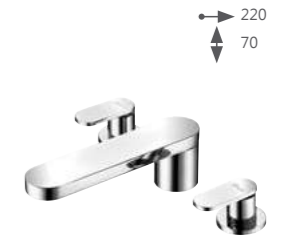

A-8570-3 (三件式)
A-8570-5 (五件式)
浴缸龍頭
3/5- Hole Tub Faucet



A-8518
廚房龍頭
Kitchen Faucet



A-8648
廚房龍頭
Kitchen Faucet



A-8614
廚房龍頭附 RO 開關
(不鏽鋼)
Kitchen Faucet w/ RO
Diverter
Stainless Steel



A-8618
廚房龍頭 (不鏽鋼)
Kitchen Faucet
Stainless steel

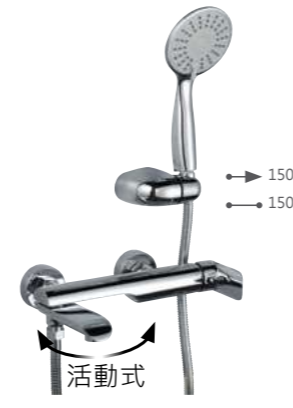

A-8660
沐浴龍頭 (活動式)
Shower Faucet



A-8602
面盆龍頭
Basin Faucet



A-8604
廚房龍頭
Kitchen Faucet



A-8620
沐浴龍頭
Shower Faucet



A-8664
廚房龍頭 (黑)
Kitchen Faucet
Matt Black



A-8665
面盆龍頭 (黑)
Basin Faucet
Matt Black



A-8654
古典廚房龍頭 (古銅)
Classic Kitchen Faucet
Vecchio Organic



A-8714
廚房龍頭
Kitchen Faucet



A-8710
沐浴龍頭
Shower Faucet



A-8653
面盆龍頭
Basin Faucet



A-8641
面盆龍頭
Basin Faucet



A-8642
面盆龍頭
Basin Faucet

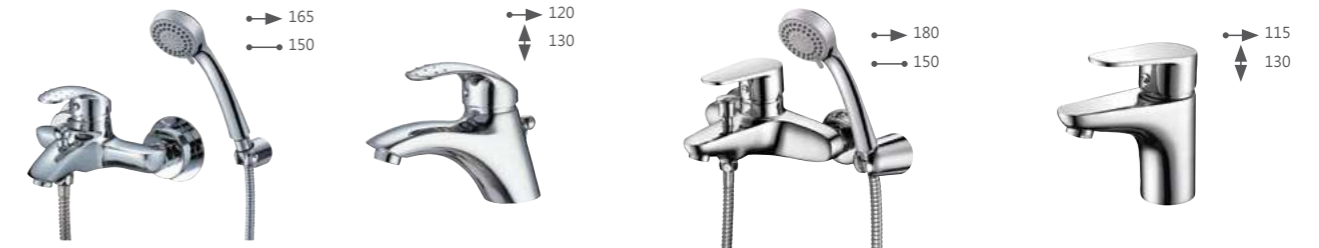

A-590
沐浴龍頭
Shower Faucet

A-595
面盆龍頭
Basin Faucet

A-8650
沐浴龍頭
Shower Faucet

A-8655
面盆龍頭
Basin Faucet



A-2830
沐浴龍頭
Cross Handle Shower Faucet

A-8510
沐浴龍頭
Shower Faucet

A-8562
面盆龍頭 (分離式)
Basin Faucet

A-8562-3 (三件式)
浴缸龍頭
3-Hole Tub Faucet



A-8500
沐浴龍頭
Shower Faucet

A-8501
面盆龍頭
Basin Faucet

A-8505
面盆龍頭
Basin Faucet

A-8509
面盆龍頭附蓮蓬頭
Basin Faucet
w / Handshower

→ Spout Reach 中心點至出水口距離 ↑ Total Height 總高 → Faucet Center 冷熱進水距離 Unit 單位 mm



A-8515
面盆龍頭
Basin Faucet

A-8516
面盆龍頭
Basin Faucet

A-8630
沐浴龍頭
Shower Faucet

A-8635
面盆龍頭
Basin Faucet

→ Spout Reach 中心點至出水口距離 ↑ Total Height 總高 → Faucet Center 冷熱進水距離 Unit 單位 mm

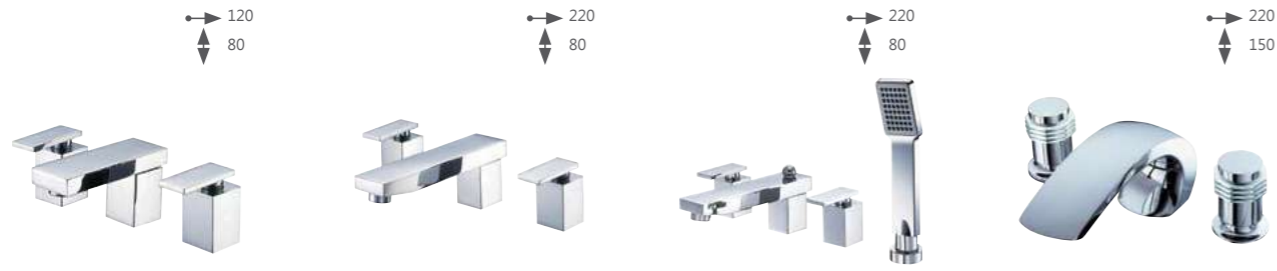

A-8512
面盆龍頭 (分離式)
Basin Faucet

A-8512-3 (三件式)
A-8512-5 (五件式)
浴缸龍頭
3/5- Hole Tub Faucet

A-8512-4 (四件式)
浴缸龍頭
4- Hole Tub Faucet

A-772-3
浴缸龍頭
3-Hole Tub Faucet



A-8580-3 (三件式)
A-8580-5 (五件式)
浴缸龍頭
3/5- Hole Tub Faucet

A-8580
面盆龍頭
Basin Faucet

A-8530-3 (三件式)
A-8530-5 (五件式)
浴缸龍頭
3/5- Hole Tub Faucet

A-8530
面盆龍頭 (分離式)
Basin Faucet
專利品 Patented



A-782
面盆龍頭 Basin Faucet
A-782-3 (三件式)
A-782-5 (五件式)
浴缸龍頭
3/5- Hole Tub Faucet

A-792
面盆龍頭 (分離式)
Basin Faucet

A-792-3 (三件式)
A-792-5 (五件式)
浴缸龍頭
3/5-Hole Cross Handle
Tub Faucet

A-792-3A
浴缸龍頭
3-Hole Tub Faucet
w/ Handshower

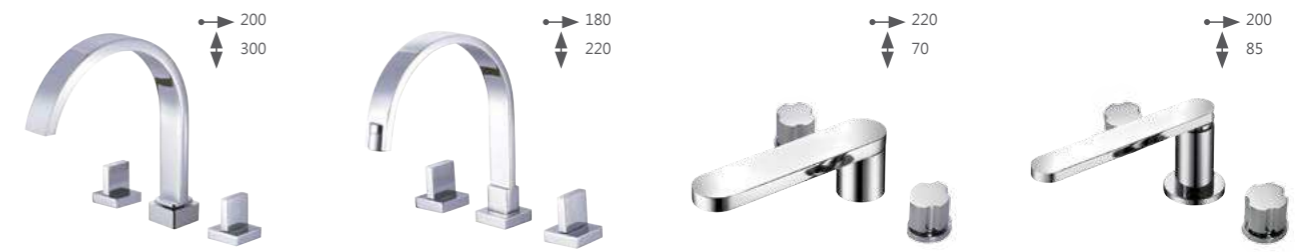

A-8532-3 (三件式)
A-8532-5 (五件式)
浴缸龍頭
3/5- Hole Tub Faucet

A-8532
面盆龍頭 (分離式)
Basin Faucet
專利品 Patented

A-8571-3 (三件式)
A-8571-5 (五件式)
浴缸龍頭
3/5- Hole Tub Faucet

A-8571
面盆龍頭
Basin Faucet

→ Spout Reach 中心點至出水口距離 ↑ Total Height 總高 → Faucet Center 冷熱進水距離 Unit 單位 mm

Elegance made in TAIWAN

Formula Faucet use to create luxurious products that are absolutely solid, sensuous, and most assuredly works of art.

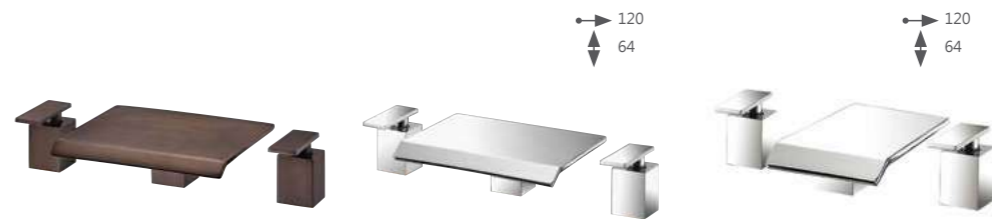

A-776-3ORB
浴缸龍頭
3-Hole Tub Faucet
Oil Rubbed Bronze

A-776-3 (三件式)
A-776-5 (五件式)
浴缸龍頭
3/5- Hole Tub Faucet

A-776
面盆龍頭 (分離式)
Basin Faucet

→ Spout Reach 中心點至出水口距離 ↑ Total Height 總高 → Plate Width 主體面板寬 Unit 單位 mm

THE MEDIEVAL

OLD WORLD CHARM



A-8732-3
浴缸龍頭 (玫瑰金)
3-Hole Tub Faucet
Rose Gold



A-8732-3
A-8732-5
浴缸龍頭
3/5-Hole Tub Faucet



A-8735
A-8735N 無鉛銅
面盆龍頭
Basin Faucet
Lead Free



A-8724
A-8724N 無鉛銅
廚房龍頭
Kitchen Faucet
Lead Free



A-8724-2
廚房龍頭 (附噴槍)
Kitchen Faucet w/ Spray



A-8732
A-8732N 無鉛銅
面盆龍頭 (分離式)
Basin Faucet
Lead Free



A-8730
沐浴龍頭
Shower Faucet



A-8725
面盆龍頭 (青古銅)
Basin Faucet
Weathered Brass Organic

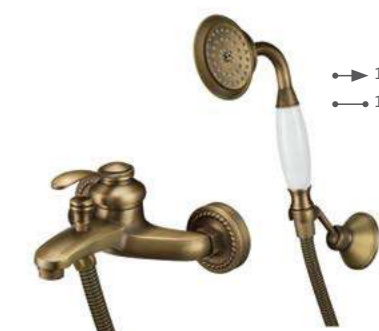

A-8720
沐浴龍頭 (青古銅)
Shower Faucet
Weathered Brass Organic

→ Spout Reach 中心點至出水口距離 ↑ Total Height 總高 → Faucet Center 冷熱進水距離 Unit 單位 mm



A-710
古典沐浴龍頭
Classic Shower Faucet

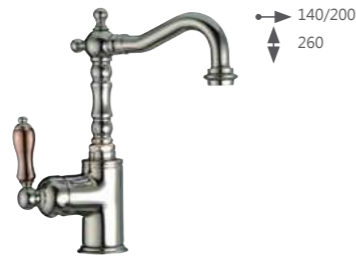

A-713
古典面盆龍頭
Classic Basin Faucet
A-714
古典廚房龍頭
Classic Kitchen Faucet
A-714-1
加高 7cm



A-715
A-715N 無鉛銅
古典面盆龍頭
Classic Basin Faucet
Lead Free



A-730
古典沐浴龍頭
Classic Shower Faucet



A-754
古典廚房龍頭
Classic Kitchen Faucet
A-755
古典面盆龍頭
Classic Basin Faucet



A-762
古典面盆龍頭 (分離式)
Classic Basin Faucet



A-710
古典沐浴龍頭 (古銅)
Classic Shower Faucet
Vecchio Organic



A-713
古典面盆龍頭 (古銅)
Classic Basin Faucet
A-714
古典廚房龍頭 (古銅)
Classic Kitchen Faucet
Vecchio Organic



A-715
古典面盆龍頭 (古銅)
Classic Basin Faucet
Vecchio Organic



A-730
古典沐浴龍頭 (古銅)
Classic Shower Faucet
Vecchio Organic

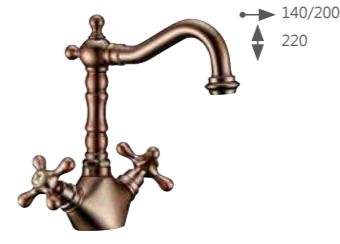

A-754
古典廚房龍頭 (古銅)
Classic Kitchen Faucet
A-755
古典面盆龍頭 (古銅)
Classic Basin Faucet
Vecchio Organic



A-714-2
古典廚房龍頭 (古銅)
Classic Kitchen Faucet
Vecchio Organic



A-8726
面盆龍頭
Basin Faucet



A-8657
面盆龍頭
Basin Faucet



A-8636
古典面盆龍頭 (青古銅)
Classic Basin Faucet
Weathered Brass Organic



A-62931
廚房龍頭
Pot Filler



A-67509 ORB
廚房龍頭 (油棕色)
Pot Filler
Oil Rubbed Bronze



A-67543
廚房龍頭
Pot Filler

→ Spout Reach 中心點至出水口距離 ↑ Total Height 總高 → Faucet Center 冷熱進水距離 Unit 單位 mm

→ Spout Reach 中心點至出水口距離 ↑ Total Height 總高 → Faucet Center 冷熱進水距離 Unit 單位 mm

THE SHOWERS



A-8350
浴缸龍頭 (含插管式預埋配件)
Freestanding Shower Set

A-8360
浴缸龍頭 (外露式)
Freestanding Tub Fillers



A-8300A
浴缸龍頭 (含插管式預埋配件)
Freestanding Tub Fillers



A-8310A
浴缸龍頭 (含插管式預埋配件)
Freestanding Tub Fillers



A-8320A
浴缸龍頭 (含插管式預埋配件)
Freestanding Tub Fillers



A-8330
浴缸龍頭 (落地型) 含預埋盒
Freestanding Tub Fillers



A-8340 MB
浴缸龍頭 (含插管式預埋配件)
Freestanding Tub Fillers

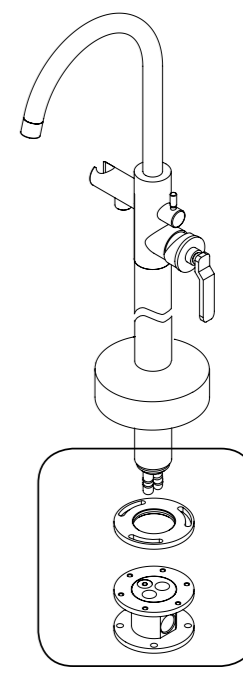

插管式預埋配件

→ Spout Reach 中心點至出水口距離 ↑ Total Height 總高 → Plate Width 主體面板寬 Unit 單位 mm



A-2700
大花灑龍頭
Shower Set



A-2710
大花灑龍頭
Shower Set



A-2720
大花灑龍頭
Tub/ Shower Set



A-2770
大花灑龍頭 (青古銅)
Tub/ Shower Set
Weathered Brass Organic



A-2730
大花灑龍頭
Tub/ Shower Set



A-2760
大花灑龍頭
Tub/ Shower Set



A-2910
大花灑龍頭
Shower Set

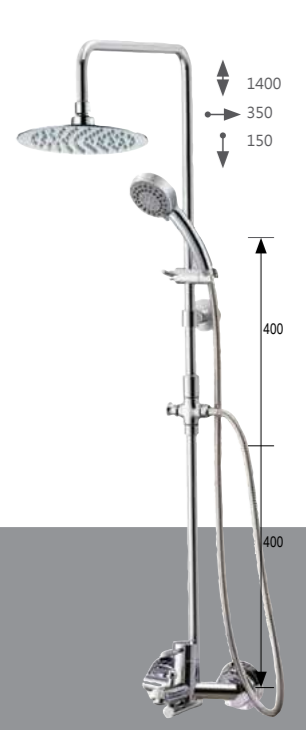

A-2920
大花灑龍頭
Tub/ Shower Set

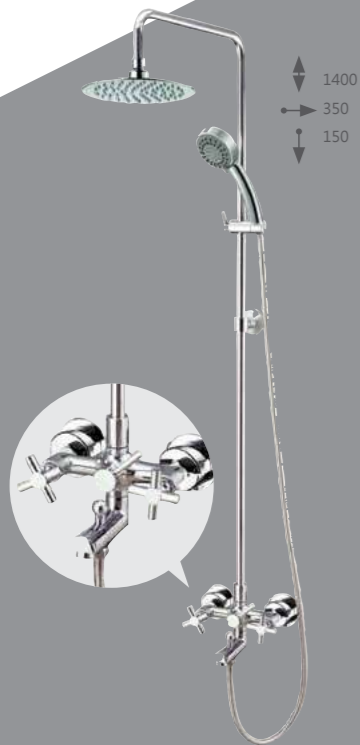

A-2800
大花灑龍頭
Tub/ Shower Set



A-2840
大花灑龍頭
Tub/ Shower Set



A-2840A
大花灑龍頭 (紅古銅)
Tub/ Shower Set
Vecchio Organic



A-2740
大花灑龍頭
Tub/ Shower Set



A-2930
大花灑龍頭
Tub/ Shower Set



A-2931
大花灑龍頭
Tub/ Shower Set



A-2900
大花灑龍頭
Shower Set

→ Shower Head Reach 頂嘴出水長 ↓ Shower Head Height 頂嘴出水高 ↑ Total Height 總高 Unit 單位 mm

→ Shower Head Reach 頂嘴出水長 ↓ Shower Head Height 頂嘴出水高 ↑ Total Height 總高 Unit 單位 mm

THE SHOWERS

With the impressive functionality and stylish elegance, the collection is ideally equipped to leave an excellent impression.



A-2820 MB
大花灑龍頭
Shower Set

A-2850 MB
大花灑龍頭
Shower Set

→ Shower Head Reach 頂噴出水長 ↓ Shower Head Heigh 頂噴出水高 ↑ Total Height 總高 Unit 單位 mm



A-2940
方型大花灑龍頭
Shower Set

A-2981
方型大花灑龍頭
Shower Set

A-2982
方型大花灑龍頭
Tub/ Shower Set



A-2990
方型大花灑龍頭
Tub/ Shower Set

A-2860
大花灑龍頭
Tub/ Shower Set

A-2890
大花灑龍頭
Tub/ Shower Set

→ Shower Head Reach 頂噴出水長 ↓ Shower Head Heigh 頂噴出水高 ↑ Total Height 總高 Unit 單位 mm

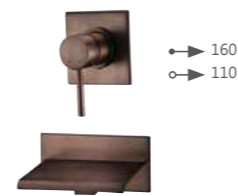

A-210-1 ORB
嵌牆浴缸龍頭 (油棕)
Concealed Tub Faucet
Oil Rubbed Bronze



A-210-1
嵌牆浴缸龍頭
Concealed Wall Mount
Tub Faucet

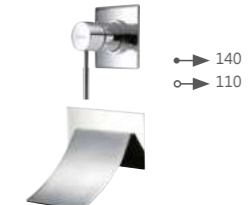

A-210-1A
嵌牆浴缸龍頭
Concealed Wall Mount
Tub Faucet



A-210-1C
嵌牆浴缸龍頭
Concealed Wall Mount
Tub Faucet

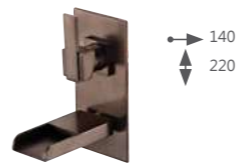

A-8557 ORB
嵌牆面盆龍頭 (油棕)
Concealed Basin Faucet
Oil Rubbed Bronze



A-8557
嵌牆面盆龍頭
Concealed Wall Mount
Basin Faucet



A-8567
嵌牆面盆龍頭
Concealed Wall Mount
Basin Faucet

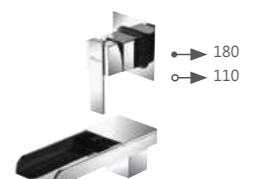

A-210-1B
嵌牆浴缸龍頭
Concealed Wall Mount
Tub Faucet



A-286
嵌牆面盆龍頭
Concealed Wall Mount
Basin Faucet

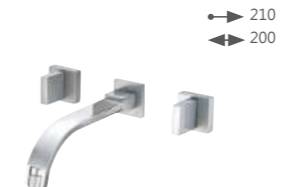

A-8527
嵌牆面盆龍頭
Concealed Wall Mount
Basin Faucet



A-8507
嵌牆面盆龍頭
Concealed Wall Mount
Basin Faucet



A-8537
嵌牆面盆龍頭
Concealed Wall Mount
Basin Faucet



A-8547
嵌牆面盆龍頭
Concealed Wall Mount
Basin Faucet

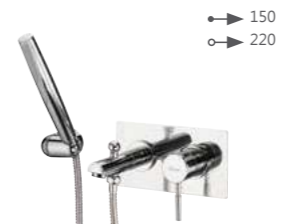

A-8520
嵌牆沐浴龍頭
Concealed Wall Mount
Shower/Tub Faucet

→ Spout Reach 中心點至出水口距離

↑ Total Height 總高

○ Plate Width 主體面板寬

Unit 單位 mm

CONCEALED SHOWER SET

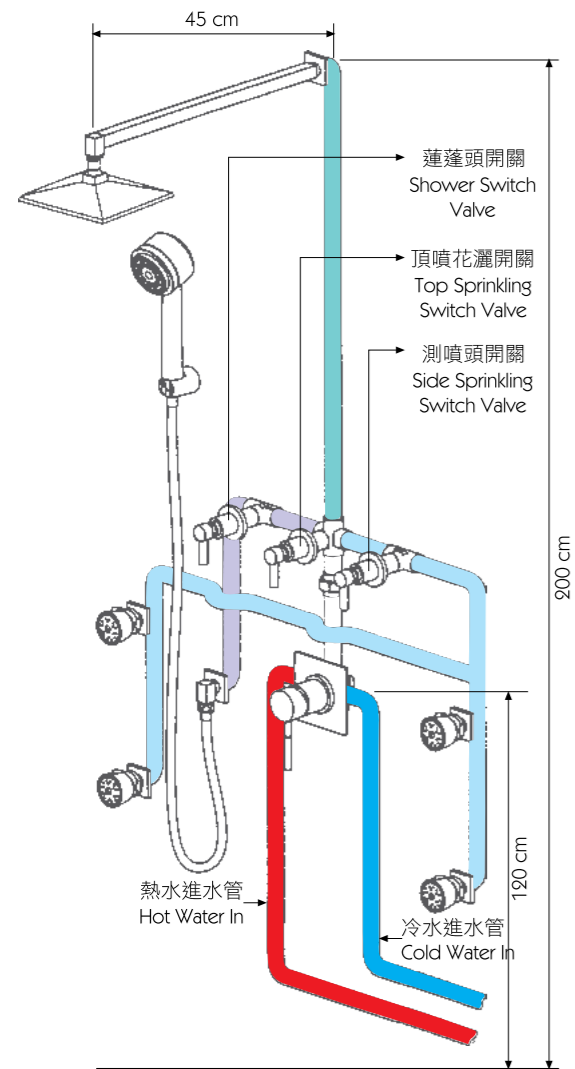

- 頂噴花灑管
- 測噴頭出水管
- 蓮蓬頭出水管
- 冷水管
- 熱水管

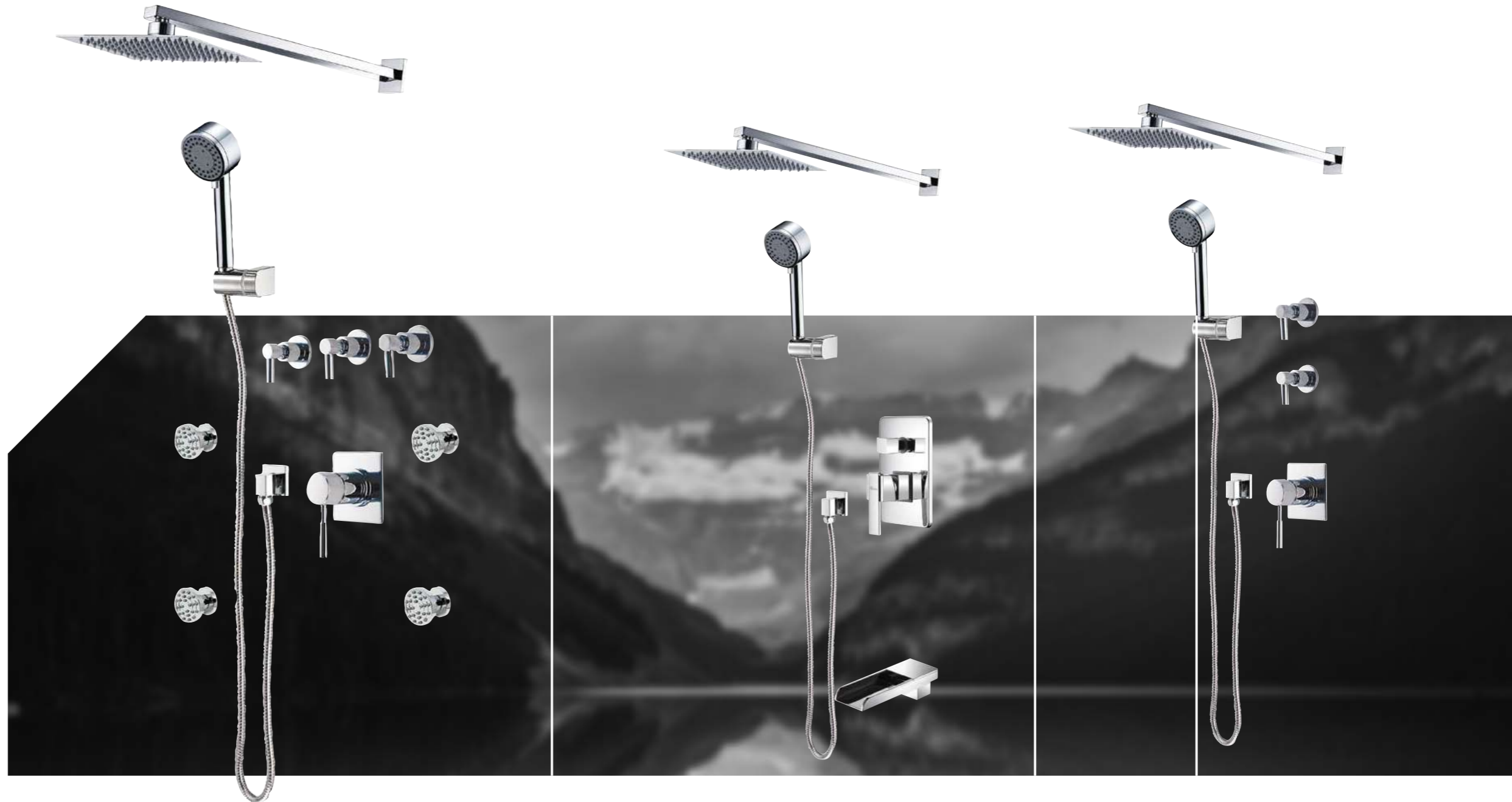

A-210-3
沐浴龍頭 (三切)
3-Way Concealed
Tub/ Shower Set

A-315-3B
沐浴龍頭 (三切)
3-Way Concealed
Tub/ Shower Set

A-210-2
沐浴龍頭 (二切)
2-Way Concealed
Shower Set

CONCEALED SHOWER SET

Formula Faucet use to create luxurious products that are absolutely solid, sensuous, and most assuredly works of art.



A-314-2
沐浴龍頭 (二切)
2-Way Concealed
Shower Set

A-314-3A
沐浴龍頭 (三切)
3-Way Concealed
Tub/ Shower Set

A-315-2
沐浴龍頭 (二切)
2-Way Concealed
Shower Set

A-210-3A
沐浴龍頭 (三切)
3-Way Concealed
Tub/ Shower Set

A-210-4
沐浴龍頭 (四切)
4-Way Concealed
Tub/Shower Set

A-210-2
沐浴龍頭 (二切)
2-Way Concealed
Shower Set

CONCEALED

TUB/SHOWER SET



A-211-2
沐浴龍頭 (二切)
2-Way Concealed
Shower Set

A-211-3
沐浴龍頭 (三切)
3-Way Concealed
Shower Set

A-211-3A
沐浴龍頭 (三切)
3-Way Concealed
Tub/ Shower Set

A-211-3B
沐浴龍頭 (三切)
3-Way Concealed
Tub/ Shower Set

A-211-4
沐浴龍頭 (四切)
4-Way Concealed
Tub/ Shower Set

A-210-2A
沐浴龍頭 (嵌牆式)
Concealed Shower Set

CONCEALED SINGLE LEVER MIXER



A-213-4
沐浴龍頭 (四切)
4-Way Concealed
Tub/Shower Set

A-317-2
沐浴龍頭 (二切)
2-Way Concealed
Shower Set

A-318-3A
沐浴龍頭 (三切)
3-Way Concealed
Tub/ Shower Set

<p>A-310+A-308-9 冷熱開關 + 三切換開關 (檯面式) Deck Mount Single Lever Mixer and 3-Way Diverter</p>	<p>A-208-9 三切換開關 Concealed 3-Way Diverter</p>	<p>A-210 嵌牆龍頭主體 Concealed Single Lever Mixer</p>	<p>A-210 ORB 嵌牆龍頭主體 (油棕色) Concealed Single Lever Mixer Oil-Rubbed Bronze</p>
<p>A-312 嵌牆龍頭主體 (二切) Concealed Single Lever Mixer w/ 2-Way Diverter</p>	<p>A-313 嵌牆龍頭主體 Concealed Single Lever Mixer</p>	<p>A-314 嵌牆龍頭主體 (二、三切) Concealed Single Lever Mixer w/ 2/3- Way Diverter</p>	<p>A-315 嵌牆龍頭主體 (二、三切) Concealed Single Lever Mixer w/ 2/3- Way Diverter</p>
<p>A-316 嵌牆龍頭主體 Concealed Single Lever Mixer</p>	<p>A-317 嵌牆龍頭主體 (二切) Concealed Single Lever Mixer w/ 2-Way Diverter</p>	<p>A-211 嵌牆龍頭主體 (二、三切) Concealed Single Lever Mixer w/ 2/3- Way Diverter</p>	



A-207-8
壁式斜瀑布
Wall Mount Waterfall Spout



A-207-8 ORB
壁式斜瀑布 (油棕)
Wall Mount Waterfall Spout
Oil Rubbed Bronze



A-208-8
壁式平瀑布
Wall Mount Waterfall Spout



A-208-8 ORB
壁式平瀑布 (油棕)
Wall Mount Waterfall Spout
Oil Rubbed Bronze

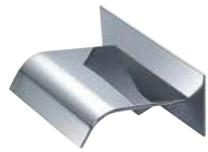

A-206-8
壁式平瀑布
Wall Mount Waterfall Spout



A-207-9
壁式水溝瀑布
Wall Mount Waterfall Spout



A-208-1
下出水管
Spout



A-208-2
切換出水管
2-Way Spout



A-208-3
出水管
Spout



A-209
頂噴出水管
Rain Shower Outlet



A-208
出水管 (天花板)
Rain Shower Ceiling
Outlet

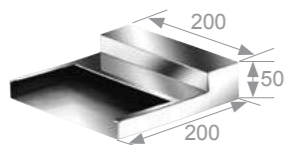

A-207-2
水溝瀑布
Concealed Waterfall Spout



A-207-6
浴缸瀑布出水 (隱藏式)
Concealed Waterfall Spout



A-207
1 英寸開關
Cross Handle 1" Valve



A-208-6
單切換開關
Single Lever Diverter



A-207-4
二切換開關
2-Way Diverter



A-207-5
三切換開關
3-Way Diverter



A-208-5
壁式灣頭
Wall Mount Outlet for
Hand Shower Hose



A-208-5B
壁式灣頭
Wall Mount Outlet



A-208-4
側噴頭
Massage Spray



A-208-5A



R-1011
圓形花灑 (銅)
Rain Shower



R-1012
方形花灑 (銅) (20cm)
Rain Shower



R-1013 (20cm)
R-1013 (30cm)
圓形花灑
Rain Shower



R-1014 (20cm)
R-1014 (30cm)
R-1014 (40cm)
方形花灑
Rain Shower



A-207-1
壁式出水頂嘴
Wall Mount Rain Shower



R-1007
方形花灑 (20x30cm)
Rain Shower

→ Spout Reach 中心點至出水口距離

↑ Total Height 總高

→ Plate Width 主體面板寬

Unit 單位 mm

ACCESSORIES



A-602
歐 P 管
Contemporary Drain Trap



A-603
開關彎頭 (伸縮壁蓋)
Angle Stop w/ Telescopic
Flange



A-626
活動掛座
Bracket



A-606
沖洗器噴槍 (銅)
含金屬軟管、三通、掛勾
Spray



A-611
單冷洗衣機柱
Washing Machine Pillar Tap



A-612
單冷長柱 (雙功能)
Pillar Tap



A-613
單冷長柱
Pillar Tap



A-614
單冷長柱 (雙功能)
Pillar Tap



A-615
二切換開關
2-Way Diverter



A-610
單冷立柱 (不鏽鋼)
Pillar Tap
Stainless steel



A-305
面盆立柱
Pillar Tap

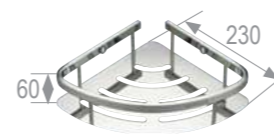

R-2013
單層置物架
Shelf



R-2015
單層置物架
Shelf

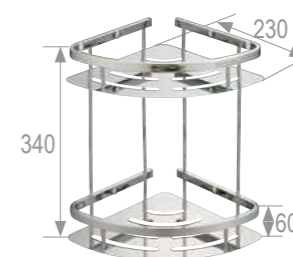

R-2014
雙層置物架
Double Shelf



R-2016
雙層置物架
Double Shelf

ACCESSORIES

Feel the difference of vibes. Experience the new generation of luxury. Indulge yourself with a work of masterpieces of Formula Faucet.



R-0007C
蓮蓬頭
Hand Shower



R-0008C
蓮蓬頭
Hand Shower



R-0009C
三段式蓮蓬頭
3-Way Hand Shower



R-0011C
三段式蓮蓬頭
3-Way Hand Shower



R-0012C
三段式蓮蓬頭
3-Way Hand Shower



R-0013C
三段式蓮蓬頭
3-Way Hand Shower



R-0014C
三段式蓮蓬頭
3-Way Hand Shower



R-0015C
三段式蓮蓬頭
3-Way Hand Shower



R-0016C
三段式蓮蓬頭
3-Way Hand Shower



R-0017C
蓮蓬頭
Hand Shower



A-608
銅升降桿 (滑桿)
Brass Shower Sliding Rail



R-1650
銅升降桿 (滑桿)
Brass Shower Sliding Rail



R-1652
升降桿 (滑桿)
Shower Sliding Rail



R-1653
升降桿 (滑桿)
Shower Sliding Rail



R-8250
銅升降桿 (滑桿)
Brass Shower Sliding Rail



R-8251
升降桿 (滑桿、肥皂盤)
Shower Sliding Rail
W/ Soap Dish

THE TRENDY

Industriell Collection



R-1203 MB
毛巾架 (60cm)
Towel Rail (24")



R-1220 MB
置衣架
Towel Rack



R-1221 MB
雙管毛巾架 (60cm)
Double Towel Rail (24")



R-1206 MB
毛巾掛環
Towel Ring



R-1210 MB
衛生紙架
Toilet Paper Holder



R-1211 MB
浴巾掛鉤
Robe Hook



R-1205 MB
肥皂盤
Soap Dish



R-1202 MB
漱口杯架
Tumbler Holder



R-1203 ORB
毛巾架 (60cm)
Towel Rail (24")

顏色選擇：

ORB 油棕色

MB 啞光黑色

CP 鍍鉻色





R-1321
雙管毛巾架 (青古銅)(60cm)
Double Towel Rail (24")
Weathered Brass Organic

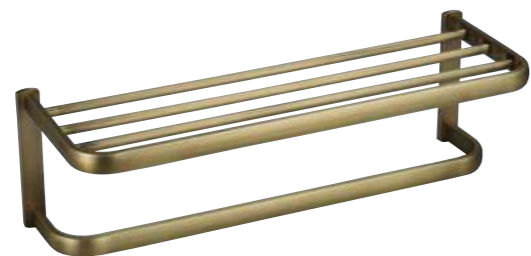

R-1320
置衣架 (青古銅)
Towel Rails
Weathered Brass Organic



R-1303
毛巾架 (60cm)
Towel Rail (24")



R-1321
雙管毛巾架 (60cm)
Double Towel Rail (24")



R-1320
置衣架
Towel Rails

THE TRENDY

Feel the difference of vibes. Experience the new generation of luxury. Indulge yourself with a work of masterpieces of Formula Faucet.



R-1306
毛巾掛環 (青古銅)
Towel Ring
Weathered Brass Organic



R-1310
衛生紙架 (青古銅)
Toilet Paper Holder
Weathered Brass Organic



R-1302
雙杯架 (青古銅)
Tumbler Holder
Weathered Brass Organic



R-1301
肥皂盤 (青古銅)
Soap Dish
Weathered Brass Organic



R-1314
清潔刷座 (青古銅)
Toilet Brush Holder
Weathered Brass Organic



R-2012
置物架 (青古銅)
Soap Basket
Weathered Brass Organic



R-1302
雙杯架
Tumbler Holder



R-1306
毛巾掛環
Towel Ring



R-1310
衛生紙架
Toilet Paper Holder



R-1803
毛巾架 (60cm)
Towel Rail (24")

R-1820
置衣架
Towel Rails

R-1821
雙管毛巾架 (60cm)
Double Towel Rail (24")



R-1500
玻璃平台架
Glass Shelf

R-1503
毛巾架 (60cm)
Towel Rail (24")

R-1521
雙管毛巾架 (60cm)
Double Towel Rail (24")

THE TRENDY

Feel the difference of vibes. Experience the new generation of luxury. Indulge yourself with a work of masterpieces of Formula Faucet.



R-1401
肥皂盤
Soap Dish



R-1402
漱口杯架
Tumbler Holder



R-1408
漱口杯架
Tumbler Holder



R-1501
肥皂盤
Soap Dish



R-1506
毛巾掛環
Towel Ring



R-1508
漱口杯架
Tumbler Holder



R-1410
衛生紙架
Toilet Paper Holder



R-1411
浴巾掛鉤
Robe Hook



R-1406
毛巾掛環
Towel Ring



R-1414
清潔刷座
Toilet Brush Holder



R-1511
浴巾掛鉤
Robe Hook



R-1515
乳液罐
Lotion Dispenser



R-1510
衛生紙架
Toilet Paper Holder



R-1514
清潔刷座
Toilet Brush Holder



R-1620
置衣架
Towel Rails



R-1621-1
雙管毛巾架 (60cm)
Double Towel Rail (24")

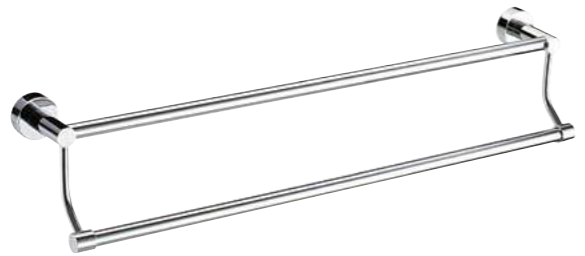

R-1621
雙管毛巾架 (60cm)
Double Towel Rail (24")



R-1600
玻璃平台架
Glass Shelf



R-1603
毛巾架 (60cm)
Towel Rail (24")

THE TRENDY



R-1611
浴巾掛鉤
Robe Hook



R-1611-4
浴巾掛鉤
Robe Hook



R-1601
肥皂盤
Soap Dish



R-1602
漱口杯座
Tumbler Holder &
Soap Dish



R-1602-1
漱口杯架
Tumbler Holder



R-1608
漱口杯座
Tumbler Holder



R-1610-1
衛生紙架
Toilet Paper Holder



R-1615
乳液罐
Lotion Dispenser



R-1614
清潔刷座
Toilet Brush Holder



R-1605
肥皂網
Soap Dish



R-1606
毛巾掛環
Towel Ring



R-1610
衛生紙架
Toilet Paper Holder



R-6600
玻璃平台架
Glass Shelf



R-6603
毛巾架 (50cm)
Towel Rail (20")



R-8200
玻璃平台架
Glass Shelf



R-8203
毛巾架 (60cm)
Towel Rail (24")



R-8220
四角置衣架 (60cm)
Towel Rail (24")



R-8221
雙管毛巾架 (60cm)
Double Towel Rail (24")

THE TRENDY

Harmoniously integrated
into the design



R-6606
毛巾掛環
Towel Ring



R-6610
衛生紙架
Toilet Paper Holder
R-6610-1 加蓋



R-8201
肥皂盤
Soap Dish



R-8208
漱口杯架
Tumbler Holder



R-8205
肥皂網
Soap Dish



R-6601
肥皂盤
Soap Dish



R-6608
漱口杯架
Tumbler Holder



R-6611
浴巾掛鉤
Robe Hook



R-6614
清潔刷座
Toilet Brush Holder



R-8206
毛巾掛環
Towel Ring



R-8210
衛生紙架
Toilet Paper Holder



R-8211
浴巾掛鉤
Robe Hook



R-8214
清潔刷座
Toilet Brush Holder



R-6500
玻璃平台架
Glass Shelf



R-6503
毛巾架 (60cm)
Towel Rail (24")

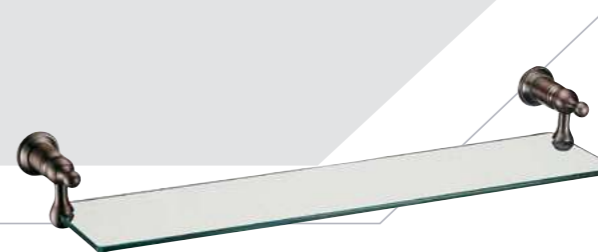

R-6500
玻璃平台架 (古銅)
Glass Shelf
Vecchio Organic



R-6503
毛巾架 (古銅) (60cm)
Towel Rail (24")
Vecchio Organic



R-6521
雙管毛巾架 (古銅) (60cm)
Double Towel Rail (24")
Vecchio Organic

Manufactured in harmony with the
utmost charm and elegance

THE TRENDY



R-6506
毛巾掛環
Towel Ring



R-6510
衛生紙架
Toilet Paper Holder



R-6506
毛巾掛環 (古銅)
Towel Ring
Vecchio Organic



R-6510
衛生紙架 (古銅)
Toilet Paper Holder
Vecchio Organic



R-6501
肥皂盤
Soap Dish



R-6508
漱口杯架
Tumbler Holder



R-6511
浴巾掛鉤
Robe Hook



R-6514
清潔刷座
Toilet Brush Holder



R-6501
肥皂盤 (古銅)
Soap Dish
Vecchio Organic



R-6508
漱口杯架 (古銅)
Tumbler Holder
Vecchio Organic



R-6511
浴巾掛鉤 (古銅)
Robe Hook
Vecchio Organic



R-6514
清潔刷座 (古銅)
Toilet Brush Holder
Vecchio Organic



總門市：章記衛廚
高雄市前金區中華三路166號
07-2868111
客服LINE ID：@154mavis



台南生活館：永昕衛廚
台南市南區健康路二段213號
06-2635899
客服LINE ID：@lys9118v



夢時代.B2：章記衛廚
高雄市前鎮區中華五路789號
07-8416540
客服LINE ID：@893kindg