

**C** 章記衛廚

KARAT

凱樂

2021  
Sanitary  
ware



給身體最細膩的感動

源自美國**148**年衛浴領導者



總門市：章記衛廚  
高雄市前金區中華三路166號  
07-2868111  
客服LINE ID：@154mavis



台南生活館：永昕衛廚  
台南市南區健康路二段213號  
06-2635899  
客服LINE ID：@lys9118v



夢時代.B2：章記衛廚  
高雄市前鎮區中華五路789號  
07-8416540  
客服LINE ID：@893kindg

品牌介紹

# OUR STORY

KARAT凱樂於1983年在泰國創立，因為卓越陶瓷技術以及對細節的用心，短短十幾年內便成為亞洲最大陶瓷生產廠，並躍升為東南亞第一衛浴品牌，更於2002年獲美國最大衛浴領導者KOHLER集團青睞，納為旗下主打品牌之一。

美國KOHLER集團擁有148年歷史，以超凡的細節與品質征服歐美，超過百年的經驗與資源也讓KARAT凱樂更上層樓，熱銷全球20多個國家。

## 領先業界

KARAT凱樂以高超技術聞名，堅持1250度以上的高溫燒透，並製出超越標準的超厚陶瓷，歷經數以千次的測試，研發出兼具省水及沖力的大管道虹吸式沖水技術，用細節成就衛浴的極致體驗。

## 創新研發

KARAT凱樂不只細心觀察使用者需求，更秉持在地化精神，引進專屬台灣市場規格的商品與零件，也積極參與國際團隊的研發，打造最適合台灣環境的衛浴設備，近年更拓展“智能衛浴科技”，打造個人化的創新感受。

KARAT

為你專注細節的用心，  
絕無止盡！

讓每一刻衛浴時光，從此成為無比的享受。



深耕台灣20多年的KARAT凱樂(鼎興開發貿易股份有限公司)為東和鋼鐵關係企業，以國際級的品質、在地化的設計、優良的售後服務，在眾多衛浴品牌中脫穎而出，吸引許多國內知名建築師認可選用。KARAT凱樂期望帶給你美式都會生活的全新享受，完美家的每一個角落。



# NEW BATHROOM SPACES

## Contents 目錄

<b>000</b>	<b>品牌介紹</b> 公司簡介 目錄 陶瓷特點	
<b>001</b>	<b>凱樂精瓷系列</b> 優貝套間 懂你套間 電腦馬桶座 單冷水馬桶蓋 月石II套間 莉萊套間 雅思套間 傑米套間 雅麗套間 凱瑞套間 潔蕾套間 潔瑤套間 潔琳套間 海棠套間 隱藏式水箱	
<b>093</b>	<b>浴室櫃系列</b> 米蘭清系列 米蘭悠悠系列 米蘭森森系列 米蘭清新系列 米蘭御鼎系列 米萊清系列 米萊悠悠系列 米萊森森系列 米萊和風系列 米萊簡約系列 米萊清悟系列 米萊悠悟系列 米萊森悟系列 米萊石悟系列 米萊鑲悟系列 微珣系列 其它浴室櫃系列	  
<b>161</b>	<b>龍頭系列</b> 龍頭系列 不鏽鋼龍頭系列 不鏽鋼廚房龍頭系列 浴缸龍頭系列 淋浴龍頭系列	
<b>185</b>	<b>浴缸系列</b> 鑄鐵浴缸 鋼板磁磚浴缸 壓克力浴缸	
<b>203</b>	<b>浴室配件系列</b> 浴室鏡/鏡櫃系列 暖風機系列 公共配件系列 配件系列 兒童衛浴系列 小配件系列 水箱零件系列	

# CONTENTS

# • 型號頁數查詢 •

## 凱樂精瓷系列

K-2268T (K-2269TN)	006
K-2267T (K-2267TN)	006
K-2279AI	011
K-2275AUTO	011
K-2277T	011
K-2275T	011
KL-990S/KL-990L	017
KL-970S/KL-970L	017
KW-206	018
KW-204	018
FB-104	019
FB-106	019
FB-108	019
K-2481U	024
K-24819L	024
K-24817L	024
K-2481W6	024
K-2481B6	024
K-2528	028
K-25289L	028
K-25287L	028
K-2528W6	028
K-2528B6	028
K-2581/K-2581P	032
K-25819L	032
K-25817L	032
K-2581W4	032
K-2581B4	032
K-2571	036
K-25719S	036
K-25717S	036
K-2571W6	036
K-2571B8	036
K-2599	040
K-25999L	040
K-25997L	040
K-2599W6	040
K-2599B6	040
K-2399	044
K-23999L	044
K-23997L	044
K-2399W6	044
K-2399B6	044
K-2596M	048
K-2596M9L	048
K-2596M7L	048
K-2596MW6	048
K-2596MB6	048
K-2896	052
K-28969L	052
K-28967L	052
K-2896W6	052
K-2896B6	052
K-2996	056
K-29969L	056
K-29967L	056
K-2996W6	056
K-2996B6	056
K-2580M	058
K-2880	058
K-2980	058
K-5558	062
K-55589L	062
K-55587L	062
K-5558W6	062
K-5558B6	062

K-5458	066
K-54589L	066
K-54587L	066
K-5458W6	066
K-5458B6	066
K-5723-K-5728/K-201A+K-8041	068
K-5713-K-5718/K-130A+K-8016	068
K-5713-K-5718/K-101B+K-8014	068
K-5723-K-5728/K-201B+K-8044	068
K-5733-K-5738/K-301A+K-8310	068
K-5131-3	068
K-5131-4	068
K-5131-5	068
K-5034-6	068
K-5034-7	068
K-5130-8	068
K-3643BP+KA-521	071
K-3643BS+KA-521	071
K-3643UP+KA-501+KA-111	072
K-3643US+KA-501+KA-111	072
K-3643BP+KA-211	072
K-3643BS+KA-311	072
K-3652N+KA-511	073
K-3658ZUP+KA-111	073
K-3658ZBP+KA-211	073
K-3658ZBP+KA-311	073
K-3111NI+KA-510	074
K-31119US+KA-111	074
K-3641US+KA-111	074
K-3919	075
KA-521	075
KA-501	075
KA-510/KA-510DC	075
KA-511/KA-511DC	075
KA-111	075
KA-211	075
KA-311	075
SH-02	075
K-2523L+DK-2221	077
K-2523L+K-2074	078
K-2523L+K-2075	078
K-2523L+DK-333	078
K-2523L+DK-322	078
K-1620M	080
K-1630	080
K-1690	080
K-1640	080
K-1135	081
K-1136+K-1037	082
K-1136+K-1536	082
K-1137+K-1037	082
K-1137+K-1536	082
MB-4713+KC-137+KR-137CF	083
K-1447N	083
K-1904F	084
K-1975	084
K-1907F	084
K-1974F	084
K-1934F	085
K-1914F	085
K-1922	085
K-1962	085
K-1903F	086
K-1923	086
K-1998	087
K-1937	087
K-1946	087

K-1413	087
K-1925	088
K-1965F	088
K-1405	088
K-1409	088
K-1438	089
K-1133	089
K-1134	089
K-1356	090
K-1383	090
K-1539	091
K-1568	091
K-1569	091
K-1580	092
K-1599F(K-1571)	092
K-1598F(K-1572)	092
K-1501	092

## 浴櫃系列

K-1360+KC-360CH	102
K-1367+KC-367CH	102
K-1361+KC-361CH	102
K-1362+KC-362CH	102
K-1363+KC-363CH	102
K-1360+KC-360CB	106
K-1367+KC-367CB	106
K-1361+KC-361CB	106
K-1362+KC-362CB	106
K-1363+KC-363CB	106
K-1360+KC-360CG	110
K-1367+KC-367CG	110
K-1361+KC-361CG	110
K-1362+KC-362CG	110
K-1363+KC-363CG	110
K-1360+KC-360CA	114
K-1367+KC-367CA	114
K-1361+KC-361CA	114
K-1362+KC-362CA	114
K-1363+KC-363CA	114
K-1360+KC-360B	116
K-1367+KC-367B	116
K-1361+KC-361B	116
K-1362+KC-362B	116
K-1363+KC-363B	116
K-1740+KC-740CH	120
K-1741+KC-741CH	120
K-1747+KC-747CH	120
K-1742+KC-742CH	120
K-1743+KC-743CH	120
K-1740+KC-740CB	124
K-1741+KC-741CB	124
K-1747+KC-747CB	124
K-1742+KC-742CB	124
K-1743+KC-743CB	124
K-1740+KC-740CG	128
K-1741+KC-741CG	128
K-1747+KC-747CG	128
K-1742+KC-742CG	128
K-1743+KC-743CG	128
K-1740+KC-740H	130
K-1741+KC-741H	130
K-1747+KC-747H	130
K-1742+KC-742H	130
K-1743+KC-743H	130
K-1740+KC-740S	132
K-1741+KC-741S	132

K-1747+KC-747S	132
K-1742+KC-742S	132
K-1743+KC-743S	132
K-1740+KC-740CHN	136
K-1741+KC-741CHN	136
K-1747+KC-747CHN	136
K-1742+KC-742CHN	136
K-1743+KC-743CHN	136
K-1740+KC-740CBN	140
K-1741+KC-741CBN	140
K-1747+KC-747CBN	140
K-1742+KC-742CBN	140
K-1743+KC-743CBN	140
K-1740+KC-740CGN	144
K-1741+KC-741CGN	144
K-1747+KC-747CGN	144
K-1742+KC-742CGN	144
K-1743+KC-743CGN	144
K-1740+KC-740CQN	148
K-1741+KC-741CQN	148
K-1747+KC-747CQN	148
K-1742+KC-742CQN	148
K-1743+KC-743CQN	148
K-1740+KC-740CFN	152
K-1741+KC-741CFN	152
K-1747+KC-747CFN	152
K-1742+KC-742CFN	152
K-1743+KC-743CFN	152
K-1916+KC-916CH	154
K-1916+KC-916CB	154
K-1916+KC-916CG	154
K-1916+KC-916CQ	154
K-1916+KC-916CF	154
K-1922T+KC-1922T	155
K-1922R+KC-922	156
K-1922R	156
K-1922L+KC-922	156
K-1922L	156
K-1236+KC-236H	157
K-1237+KC-237H	157
K-1934F+KC-934	157
K-1424+KC-424	158
K-1862+KC-862W	158
K-1803+K-1583+GM-004	158
K-182W	158
SK-2809+GM-003	158

## 龍頭系列

F-F1500	165
F-F1510	165
F-F2510	165
F-F2511	165
F-P1190	166
F-P2190	166
F-F1408DW	166
F-F2403DW	166
F-F1520	166
F-F2520	166
F-F2521	166
F-P1090/F-P1090LF	167
F-P2090	167
F-P2090L	167
F-P2453	167
F-P1070	168
F-P2070	168
F-P1401	168

F-P1400	168
F-P1662	168
F-P2010	168
F-P2611	168
F-P1630	169
F-P1713	169
F-P1693	169
F-P3190	169
F-P2713	169
F-P2693	169
AC-520	170
AC-530	170
AC-550	170
AF-363	170
AT-617	170
AF-330	170
F-P7596	171
F-P7597	171
F-P7598	171
F-P7599	171
F-P7591	171
F-P7592	171
F-P7593	171
F-P7595	171
F-P7192	172
F-P7193	172
F-P7195	172
F-P2291	172
F-P2292	172
F-P2293	172
F-P2580	172
F-P2581	172
F-F1420ST	173
F-F2701ST	173
F-F1208ST	173
F-F2708ST	173
F-F1370ST	174
F-F1390ST	174
F-F1412ST	174
F-F2370ST	174
F-F2390ST	174
F-F2162ST	174
F-F1330ST	175
F-F1320ST	175
F-F5183ST	176
F-F5193ST	176
F-F2183ST	176
F-F2293ST	176
F-F7100ST	177
F-F7611ST	177
F-F7323ST	177
F-F7100ST+	177
F-F7621ST	177
F-F7080ST	177
F-F7210ST	178
F-F7110ST	178
F-P7612	178
F-F7230ST	178
F-F7240ST	178
F-P5750LF	178
F-P6183	179
F-P6013	179
F-P6133	179
FP-6150ST	179
F-P9630	179
F-P6033/F-P6035	179
F-P6053/F-P6055	179
F-P6063/F-P6065	179

SB-107	180
SB-107A (SC-107A)	180
FS-110	180
F-F2151B	181
F-F5151B	181
F-F5151	181
F-P2110	181
F-P5110	181
F-P5390B	181
F-F5390X	181
F-P5363	182
F-P5360	182
F-P5370	182
F-J330 ABS	183
F-J117C	183
F-J227 ABS	183
F-J228 ABS	183
F-J110C	183
F-JB110C	183
F-J114C	183
F-JB113	183
F-J120C	183
F-J131C	183
F-JB132	183
F-J133C	183
F-J132C	183
F-JB135	183
F-J131C-1	183
F-JB151	183
F-J150C	183
F-JB115	183
F-JB500	183
FA-1505	184
FA-1506	184
KW-118B	184
KW-2214	184
KW-2114	184
KW-2043	184
KW-3114	184
KW-2042	184
K-005ST	184
K-005LST	184
K-005FST	184
K-005LFST	184
K-005PST	184
K-005FPST	184

**浴缸系列**

BT1779	190
BT1478	192
BT1578	192
BT8475	194
BT8575	194
BT8675	194
BT8775	194
BT8780	194
BT7070	196
BT7270	196
BT7370	196
BT7470	196
BT7570	196
BT7670	196
BT7770	196
BT-6575	198
BT-6775	198

BT-6880	198
V-20A	199
V-30A	199
V-40A	199
V-50A	199
V-60A	199
V-70A	199
AH-1001	200
SL-1086(空缸)	201
SL-1073(空缸)	201
BA1490(空缸) BA1490T(按摩浴缸)	201
BA1250(空缸) BA1250T(按摩浴缸)	201
BA1810(空缸) BA1810T(按摩浴缸)	201
BA1473(空缸) BA1473T(按摩浴缸)	202
BA1573(空缸) BA1573T(按摩浴缸)	202
BA1673(空缸) BA1673T(按摩浴缸)	202
BA1575(空缸) BA1575T(按摩浴缸)	202
BA1675(空缸) BA1675T(按摩浴缸)	202
BA1585(空缸) BA1585T(按摩浴缸)	202
BA1812(空缸) BA1812T(按摩浴缸)	202
BA1712(空缸) BA1712T(按摩浴缸)	202

**五金配件系列**

MB-6080L	206
MB-8080L	206
MB-9080L	206
MB-10080L	206
NC-6080L-R	206
NC-6080L-L	206
NC-4827G	207
NC-4874	207
NC-4827G-CB	207
NC-4837G-CB	207
NC-4839G-CH	207
NC-4811	207
MF-4912/MF-4922	208
MF-4932/MF-4942	208
MF-4926F	208
MF-4926H/MF-4936H	208
NF-4958/NF-4959	208
MB-4822G/MB-4822G-1	208
MB-4812G/MB-4812G-1	208
MB-4833BG/MB-4834BG	208
NB-4601	208
KB-1351(有線)/KB-1352(無線)	210
KB-1241	211
KB-1086	212
KH-2005	212
KH-3005	212
K-6941	213
K-6942	213
K-6943	213
K-6944	213
K-6945	213
K-6946	213
K-6947	213
K-6947D	213
K-6948	213
K-6949	213
K-6211	214
K-6212	214
K-6213	214
K-6214	214
K-6216	214
K-6217	214
K-6217D	214
K-6218	214
K-6219	214

K-6584	214
K-0027	214
K-0063	214
K-0155	214
K-0025	214
K-0021	214
K-0018	214
SB-1091D	215
SB-1062	215
SB-1062D	215
SB-1073	215
SB-1054	215
SB-1036	215
SB-1045	215
SB-6108	215
SB-1019	215
SB-1027	216
SB-1027-1	216
SB-1027D	216
SB-6091	216
SB-3105	216
SB-3105D	216
SB-1046	216
SB-1511	216
SB-6291	216
SB-6154	216
SC-2605	217
SC-2625	217
SC-2601	217
SC-2621	217
SC-1027	217
SC-1037	217
SB-6401	217
SB-1028	217
SC-3105A	217
SC-3106	217
SC-2608	218
SC-1019	218
SC-2611	218
KF2006HZ	220
K-2275T	222
K-5558+DK-2221	222
K-8896F+DK-331	222
K-8658F+DK-331	222
KH-6121B	223
KH-6158B	223
KH-6111B	223
KH-6141B	223
KH-6110B	223
KH-6150B	223
KH-6159B	223
KH-6111	224
KH-6141	224
KH-6175	224
KH-6121	224
KH-6150	224
KH-6110	224
KH-6158	224
KF-1080	226
KF-8011	226
KF-9025	226
KF-3025	226
SK-5311	226
KF-1866	226
KF-1867	226
KF-1918	226
KF-5014	226
KF-9018	226

KF-8028	226
KF-5016	226
KE-1700	226
KF-003	226
KS-6028	226
KS-6028S	226
KS-6002	226
K-2742	228
K-3651/SH-02	228
KD-9008	228
KD-9012	228
FR-3015/FR-3020/FR-3025/FR-3030	229
FR-3040/FR-3050/FR-3060	229
FR-6015/FR-6020/FR-6025	229
FR-6030/FR-6040	229
FC-5020/FC-5030/FC-5040/FC-5050	229
FC-5060/FC-5080	229
FC-3020/FC-3030/FC-3040/FC-3050	229
FC-3080/FC-3080	229
FL-5015/FL-5020/FL-5025/FL-5030	229
FL-1515	229
FL-2020	229
FL-6020/FL-6025/FL-6030	229
FL-7015/FL-7020/FL-7030	229
FL-1010ST-1	229
FL-1010ST-2	229
SW-1020/SW-1030/SW-1040	229
SW-1050/SW-1060	229
FL-1010ST-3	229
FE-8018/FE-8028/FE-8058	229
FH-1005/FH-1007/FH-1010	230
FH-1012/FH-1015/FH-1020	230
FH-1025/FH-1030/FH-1040	230
KA-126RD	230
DK-323	230
DK-322	230
DK-332	230
DK-333	230
DK-331	230
DK-330	230
進水器 ST100AD	232
5分靜音進水器 ST1012	232
4分靜音進水器 ST1012-1	232
5分靜音高壓軟管BHP30/BHP45/BHP60	232
4分靜音高壓軟管BHP30-1/BHP45-1/BHP60-1	232
落水器 K-71001	232
排污直管 K-790	232
排污伸縮管 K-790B	232
排污伸縮管 K-790L	232
4轉5分轉接頭	232
倒式沖水按鈕 K-519	232
止水蓋 K-886G	232
萬用止水蓋 K-555C	232
B2止水蓋 K-730	232
鍍鎳軟管 FDE-016	232
沖洗配件-白EB-C003	232
塑膠螺絲落水頭 G-014B	232
塑膠拉桿落水頭 G-015	232
美規落水頭 G-018	232
美規無油水孔落水頭 G-018-1	232
歐規落水頭 G-018A	232
不銹鋼美規按壓落水頭 SB-028	232
萬向管 G-024	232
鍍鎳P管 G-021	232
鍍鎳P管(加長型) G-021L	232
塑膠P管 G-022	232
塑膠S管 G-023	232
鋼製T管 G-025	232



凱樂 **KARAT** 奈潔技術是在釉的表面再上一層防污奈潔釉,經攝氏1250高溫全瓷化煅燒而成。奈潔釉為奈米級分子可將在陶瓷結晶表面毛細孔予以填平,陶瓷表面光滑細膩,本技術會讓陶瓷親水性變強。污物黑斑水垢尿垢等不易沾附。



傳統馬桶  
釉面圖



傳統陶瓷顯微表面

奈潔馬桶  
釉面圖



奈潔陶瓷顯微表面

凱樂 **KARAT** 奈潔釉是經1250度以上高溫全瓷化煅燒而成,長效型防污效果。(非一般出窯後再塗層的短效型抗污)

省水調節器 (虹吸式馬桶專用可調節水量補水器)



省水調節器可調節水量

一般虹吸式馬桶存水封補水滿時都無法停止補水,是因為必須等候水箱進水滿位後才會停止,這樣馬桶每沖一次水則浪費約0.2公升的水。**KARAT** 虹吸式馬桶全配備虹吸式馬桶專用可調節水量補水器,可將補水時間與水箱內的進水時間調整成一致,故每次馬桶沖水平均可省0.2公升水。以一般小家庭4人成員,每人每天如廁5次,則馬桶每天需沖水20次,如果使用 **KARAT** 省水調節器,則可每天節省4公升水。如果以全臺灣人口核計0.2公升x2300萬人口x5次x365天/1000=8,395,000噸水如果臺灣所有虹吸式馬桶全安裝這省水調節器,則臺灣每年可省八百多萬噸的水。

瓷器特性:

掛式面盆可承重達228公斤/10分鐘  
(中華民國CNS標準為113.4/公斤/10分鐘)



**KARAT** 瓷器厚度均設為10mm±1安全結構領先(一般市售國內知名廠牌大多為6mm-8mm)

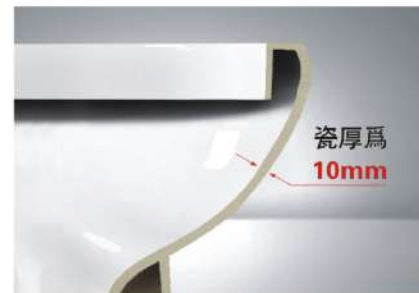

掛式馬桶或落地式可承重達400公斤/10分鐘  
(中華民國CNS尚無此測試標準)



管道全施釉沖水順暢堅久耐用  
Pipeline glaze technique



貼心設計: 徒手可安裝馬桶 (不須使用工具)



1. 不需要使用工具也可以安裝凱樂分體馬桶。(包含固定馬桶螺絲及進水軟管皆可徒手鎖緊)。



2. 凱樂分體馬桶在出廠前水箱零件已安裝好,並把螺絲也固定在水箱上。



3. 徒手將兩邊螺母鎖緊至水箱貼住馬桶底座即可。

-  表示經濟部水利署金級省水標章
-  表示經濟部水利署省水標章
-  表示智能馬桶
-  表示靜音馬桶
-  表示馬桶蓋緩降功能
-  表示智潔技術
-  大管道設計(不容易堵塞)
-  表示直沖式馬桶
-  表示噴射虹吸式
-  表示正沖噴射虹吸式
-  表示3/4.8升沖水量
-  表示4.5升沖水量
-  表示3/4.8升沖水量
-  表示2.8/4.2升沖水量
-  表示3/6升沖水量
-  表示3/4.2升沖水量

KARAT Exquisite Ceramics 凱樂精瓷



Your  
Opinion  
We Care

關愛用戶，關愛合作夥伴，  
關愛我們的生活環境。

Yobei  
Suite 優貝套間

SUITES

003 004

· 綜合系列 ·



KELLY HOPPEN HOME  
sel  
OSTV  
Bride & Groom's wedding  
HOME

TOILET PAPER  
TOWELS  
SOAP





靜音沖水 | 金級省水

Clean+  
奈潔技術



YOBEI 優貝  
K-2268T  
(K-2269TN)

- 智能馬桶 (自動掀蓋 • 內置泵浦)
- Intelligent toilet
- Size: 710x385x520mm
- S-trap: 300/400mm Roughing-In
- 適用水壓/water pressure available: 0.5kgf/cm<sup>2</sup>~7.5kgf/cm<sup>2</sup>
- List Price: **\$ 168,500.**

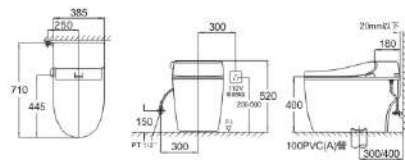

YOBEI 優貝  
K-2267T  
(K-2267TN)

- 智能馬桶 (手動掀蓋 • 內置泵浦)
- Intelligent toilet
- Size: 710x385x520mm
- S-trap: 300/400mm Roughing-In
- 適用水壓/water pressure available: 0.5kgf/cm<sup>2</sup>~7.5kgf/cm<sup>2</sup>
- List Price: **\$ 132,500.**

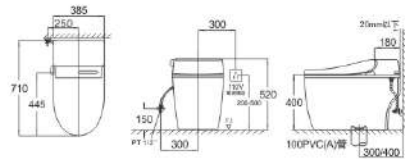



超薄

超薄水箱式全智能馬桶



尺寸：710x385x520mm

整體縮小、坐圈加大！



295mm

- 業界最薄水箱式智能馬桶，同時可滿足美觀與靜音的需求。
- 馬桶總長僅71公分，適合大部分的衛浴空間，不用擔心空間不足，無法享受高級的生活品質。



靜音

高水箱 低水箱



水箱每降低1cm可降低1%噪音

102%	21cm	● 超靜音-凱樂採用水箱式進水，比直接連水式馬桶安靜。
100%	20cm	
98%	19cm	● 根據研究，水箱每降低1cm可以降低1%的噪音值，凱樂全智能馬桶，為目前業界最低水箱式智能馬桶，減少住家環境噪音，提供消費者更優質健康的生活。
96%	18cm	
94%	17cm	
92%	16cm	
90%	15cm	
88%	14cm	
86%	13cm	
84%	12cm	



省水

兩段式沖水，超精準、超省水

- 超省水-3公升/4.5公升兩段式排水。
- 首創電磁閥自動排水設計，可精準排水水量及防止汙水倒灌回流至水箱內。

※一次大號用水量比較



凱樂馬桶 4.5L

他牌馬桶 6L



快速

超快速

- 超快速-陶瓷管道前置。
- 陶瓷管道前置沖水速度比後置較快，可大大縮短沖水產生的噪音。



陶瓷管道前置-正沖



陶瓷管道後置-反沖

Introduction to intelligent toilet



噴桿



- 單桿噴桿
  - 噴桿功能：單孔-臀洗 / 多孔-婦洗
  - 伺候系遠：(不需手動拉出噴嘴清洗，噴嘴可自動伸出)
- 噴桿材質：抗菌ABS材質添加日本富士化工株式會社的Bactekiller抗菌劑  
Bactekiller抗菌劑特點：1.超群的抗菌、防霉性。 2.良好的耐熱性  
3.可靠的安全性



瞬熱



烘乾



- 噴桿出口增加了擋片，可防止噴桿出口被噴濺。



安全

漏電斷路器



- 漏電斷路器
- 漏電斷路器，電流有問題會自動斷開接電並關閉電源防止意外發生。

水電分離

- 進水口與電源不同側，使用上更安全。



夜燈



遙控



- 一鍵通功能增加旋轉鈕自動回歸。
- 簡化手動沖水按鍵於一鍵通按鈕中。
- 按鈕面積增大，更容易操作。



- 遙控器面積增加，識別清楚。
- 可自動識別大小號。



- 遙控器面積增加，識別清楚。
- 可自動識別大小號。

Donny  
Suite 懂你套間

SUITES  
· 綜合系列 ·

009 010



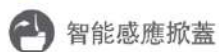

**K-2279AI**  
• 全智能馬桶(AI人工智能辨識)  
Intelligent toilet  
List Price: **\$ 288,000.**

**K-2275AUTO**  
• 全智能馬桶(智能距離辨識)  
Intelligent toilet  
List Price: **\$ 155,000.**

**K-2277T**  
• 全智能馬桶  
Intelligent toilet  
List Price: **\$ 135,000.**

**K-2275T**  
• 全智能馬桶  
Intelligent toilet  
List Price: **\$ 115,000.**

## 智能掀蓋模式

### 站立如廁



### 坐式如廁



### 無礙通過



經過馬桶



沒有使用，不會自動掀蓋



使用後自動關蓋



關蓋後再沖水，保持衛生

### 關蓋沖水

產品尺寸:

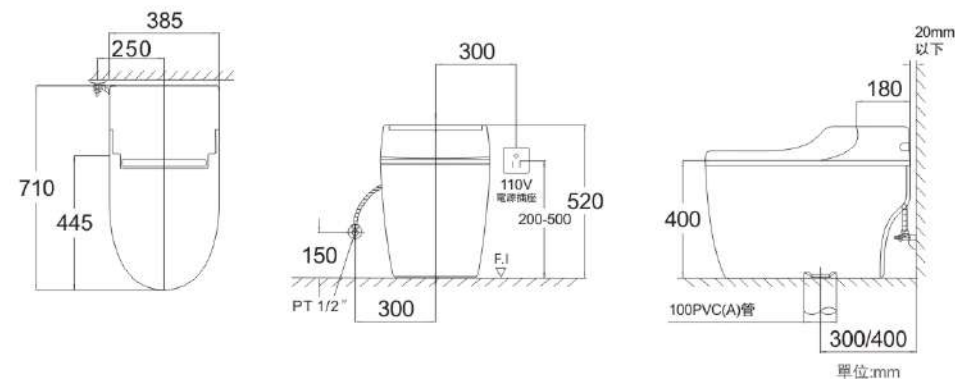



超薄水箱式全智能馬桶



尺寸：710x385x520mm

整體縮小、坐圈加大！



- 業界最薄水箱式智能馬桶，同時可滿足美觀與靜音的需求。
- 馬桶總長僅71公分，適合大部分的衛浴空間，不用擔心空間不足，無法享受高級的生活品質。



靜音



水箱每降低1cm可降低1%噪音

102%	21cm	• 超靜音-凱樂採用水箱式進水，比直接進水式馬桶安靜。
100%	20cm	
98%	19cm	• 根據研究，水箱每降低1cm可以降低1%的噪音值，凱樂全智能馬桶，為目前業界最低水箱式智能馬桶，減少住家環境噪音，提供消費者更優質健康的生活。
96%	18cm	
94%	17cm	
92%	16cm	
90%	15cm	
88%	14cm	
86%	13cm	
84%	12cm	



省水

兩段式沖水，超精準、超省水

- 超省水-3公升/4.5公升兩段式排水。
- 首創電磁閥自動排水設計，可精準排水水量及防止汙水倒灌回流至水箱內。

※一次大號用水量比較



凱樂馬桶 4.5L



他牌馬桶 6L



快速

超快速

- 超快速-陶瓷管道前置。
- 陶瓷管道前置沖水速度比後置較快，可大大縮短沖水產生的噪音。



陶瓷管道前置-正沖



陶瓷管道後置-反沖

Introduction to intelligent toilet



噴桿

- 抗菌銀離子噴桿 K-2275AUTO/K-2275T



臀洗

- 不鏽鋼噴嘴 K-2279AI/K-2277T



婦洗



單孔通便

僅下列型號有此功能  
K-2277T / K-2279AI



臀洗



婦洗



瞬熱



烘乾

- 噴桿出口增加了擋片，可防止噴桿出口被噴濺。



安全

漏電斷路器



- 漏電斷路器，電流有問題會自動斷開接電並關閉電源防止意外發生。
- 水電分離
- 進水口與電源不同側，使用上更安全。



夜燈



遙控



- 隱藏多功能操作面板。
- 設置於馬桶右側，方便操作。



- 適用於：K-2275T



- 適用於：K-2277T  
K-2279AI  
K-2275AUTO

產品功能對照表



系列	Donny 懂你系列				Yobei 優貝系列	
	K-2279AI	K-2277T	K-2275AUTO	K-2275T	K-2268T (K-2269TN)	K-2267T K-2267TN
掀蓋方式	AI智能辨識掀蓋	手動掀蓋	距離感應掀蓋	手動掀蓋	自動感應掀蓋	手動掀蓋
掀座方式	AI智能辨識掀座	手動掀座	距離感應掀座	手動掀座	遙控掀座	手動掀座
操控方式	遙控器/隱藏面板	遙控器/隱藏面板	遙控器/隱藏面板	遙控器/隱藏面板	遙控器/旋鈕	遙控器/旋鈕
加熱方式	瞬熱式	瞬熱式	瞬熱式	瞬熱式	瞬熱式	瞬熱式
泵浦模式	水泵	水泵	氣泵	氣泵	氣泵	氣泵
智慧沖水 <small>(自動辨別大小號沖大小水)</small>	●	●	●	●	●	●
臀洗	●	●	●	●	●	●
婦洗	●	●	●	●	●	●
單孔通便	●	●				
噴頭自潔	●	●	●	●	●	●
往復	●	●			●	●
按摩	●	●			●	●
烘乾	●	●	●	●	●	●
除臭	●	●			●	●
節電	●	●	●	●	●	●
暖座	●	●	●	●	●	●
緩降馬桶座蓋	●	●	●	●	●	●
自動防臭補水	●	●	●	●	●	●
自動潤壁	●					
感應夜燈	●	●	●	●	●	●
UV殺菌燈	●					



溫水通便 (單孔水柱)



臀部清洗 (三孔氣泡)



女性清洗 (九孔霧珠)

遙控型



KL-990S/KL-990L

- 水護士養生電腦馬桶座  
Health intelligent toilet seat  
Size: 485x395x185mm(短座)  
Size: 525x395x185mm(長座)  
List Price: **\$ 35,800.**

按鍵型



KL-970S/KL-970L

- 水護士養生電腦馬桶座  
Health intelligent toilet seat  
Size: 485x475x185mm(短座)  
Size: 525x475x185mm(長座)  
List Price: **\$ 30,800.**

長座

產品尺寸:



適裝尺寸:

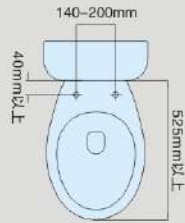

短座

產品尺寸:

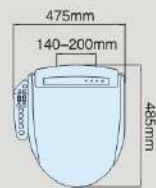

適裝尺寸:

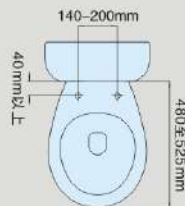

旋鈕開關 臂洗-往前轉  
婦洗-往後轉



臀部清洗 (三段水溫)



女性清洗 (三段水溫)

美式座圈



KW-206

- 超薄型瞬熱式電腦馬桶座  
Health intelligent toilet seat  
Size: 508x374x95mm  
List Price: **\$ 22,000.**

歐式座圈



KW-204

- 超薄型瞬熱式電腦馬桶座  
Health intelligent toilet seat  
Size: 512x375x95mm  
List Price: **\$ 24,800.**

美式座圈

產品尺寸:



適裝尺寸:

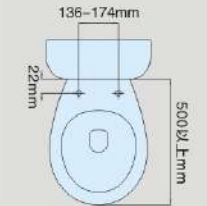

歐式座圈

產品尺寸:

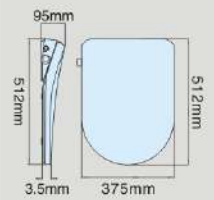

適裝尺寸:

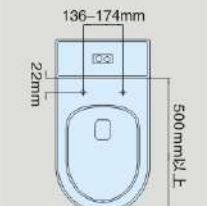

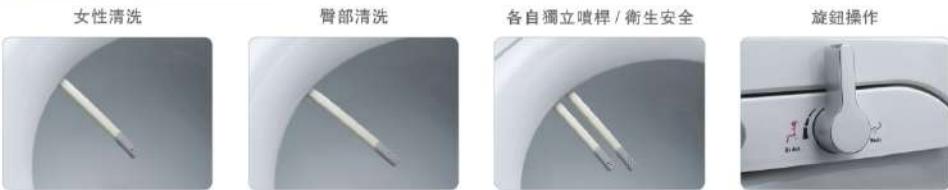

- 不用電源
- 各自獨立臀洗及婦洗噴桿
- 全系列馬桶蓋緩降設計
- 除方形馬桶座外,其餘大多皆可適裝

適裝歐系馬桶 馬桶前緣為U型

適裝台灣、美國、日本  
品牌馬桶屬長尖型

適裝台灣、美國  
品牌馬桶屬短圓型



**FB-104**

- 單冷水馬桶座 (歐式U型)
- Cold water toilet seat
- Size: 490x375x62mm
- List Price: **\$ 8,000.**

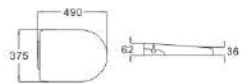

單冷水馬桶座適用馬桶尺寸範圍:

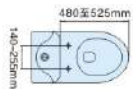

**FB-106**

- 單冷水馬桶座 (長座)
- Cold water toilet seat
- Size: 493x375x62mm
- List Price: **\$ 8,000.**

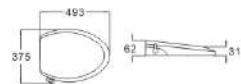

單冷水馬桶座適用馬桶尺寸範圍:

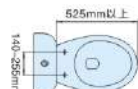

**FB-108**

- 單冷水馬桶座 (長座)
- Cold water toilet seat
- Size: 470x375x62mm
- List Price: **\$ 8,000.**

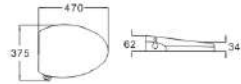

單冷水馬桶座適用馬桶尺寸範圍:

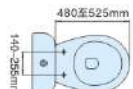

**蟲卵剋星** (本濾芯過濾20微米一般水塔內常有蟲卵,蟲卵一般為30至50微米)

使用壽命: 建議使用3-6個月 適用機型: KL-990 / KL-970 / KW-206 / KW-204各式4分牙免治接頭皆可裝

- 免治馬桶濾芯
- 型號: KL-500 牌價: **\$800**

產品功能對照表

系列	水護士		Simple+	
	美式座圈 (有分長短座)	美式座圈 (有分長短座)	美式座圈	歐式座圈
產品名稱	KL-990	KL-970	KW-206	KW-204
臀洗	●	●	●	●
婦洗	●	●	●	●
座溫	●	●	●	●
水溫	●	●	●	●
烘乾	●	●	●	●
除臭	●	●	●	●
水壓調節	●	●	●	●
抗菌噴嘴	●	●	●	●
抗菌座圈	●	●	●	●
噴頭自潔	●	●	●	●
噴頭更換	●	●	●	●
噴頭移動	●	●	●	●
噴頭往復	●	●	●	●
按摩功能	●	●	●	●
自動夜燈	●	●	●	●
夜燈	●	●	●	●
夜燈可關閉	●	●	●	●
殺菌燈	●	●	●	●
驅動馬達	●	●	●	●
節電	●	●	●	●
漏電斷路器	●	●	●	●
防低溫燙傷	●	●	●	●
緩降座圈	●	●	●	●
人體感應座圈	●	●	●	●
安全警報	●	●	●	●
加贈濾心	●	●	●	●
斷電可沖洗	●	●	●	●
使用電壓	110V 60HZ		110V 60HZ	110V 60HZ
耗電功率	交流電660W(最大值)		960W(最大瞬間功率1450W)	960W(最大瞬間功率1450W)
水壓範圍	0.4-4.5Kgf/cm2		1-7Kgf/cm2	1-7Kgf/cm2
水溫控制	4段(常溫,34度,37度,41度)		3段(常溫,35度,38度)	3段(常溫,35度,38度)
座溫控制	4段(常溫,34度,38度,41度)		3段(常溫,33度,37度)	3段(常溫,33度,37度)
水箱容量	1.4L			
水箱加熱功率	600瓦			
電源線長	1.5M		1M	1M
加熱方式	儲熱式		瞬熱式	瞬熱式
出水方式	水泵浦		氣泵浦	氣泵浦
防水等級	IPX4		IPX4	IPX4
控制方式	遙控器		按鍵面板	旋鈕



SUITES 0  
· 綜合系列 ·



靜 | 淨 | 省



MOON STONE II 月石 II  
**K-2481U**

- 噴射虹吸式單體馬桶 (尿脛防刮緩降馬桶蓋)  
Siphonic jet monomer toilet  
Size: 760x490x570mm  
S-trap: 300/400mm Roughing-in  
適用水壓/water pressure available:  
0.3kgf/cm<sup>2</sup>—7.5kgf/cm<sup>2</sup>

List Price: **\$ 35,800.**



適裝電腦馬桶座

KL-990L



KL-970L



KW-206



FB-106



**K-24819L**

- 養生靜音電腦馬桶組 (遙控式)  
Health Mute intelligent toilets group  
List Price: **\$66,600.**

**K-24817L**

- 養生靜音電腦馬桶組 (按鍵式)  
Health Mute intelligent toilets group  
List Price: **\$61,600.**

**K-2481W6**

- 預熱式靜音電腦馬桶組  
In-line heater intelligent toilet  
List Price: **\$52,800.**

**K-2481B6**

- 單冷水潔身單體靜音馬桶  
Cold water clean body monomer  
List Price: **\$38,800.**

產品尺寸

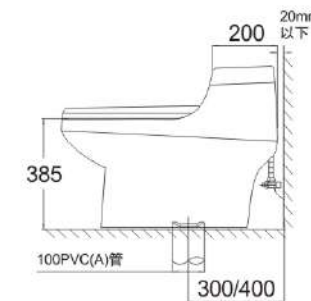
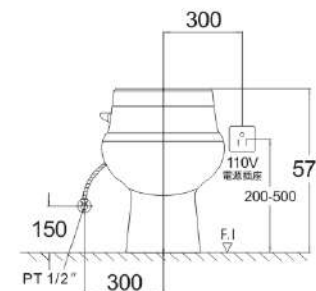
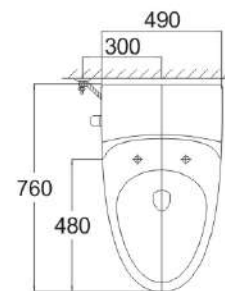

單位:mm

Kila  
Suite 莉萊套間



SUITES  
· 綜合系列 ·

025 026



無透氣管 | 金級省水  
強力排污 | 2.8L/3.2L



LILA 莉萊  
**K-2528**

- 噴射虹吸式單體馬桶  
Siphonic jet monomer toilet  
Size: 700x375x725mm  
S-trap: 300/400mm Roughing-in  
適用水壓/water pressure available:  
0.3kgf/cm<sup>2</sup>~7.5kgf/cm<sup>2</sup>

List Price: **\$38,800.**



適裝電腦馬桶座



**K-25289L**

- 養生電腦馬桶組 (遙控式)  
Health Mute intelligent toilets group  
List Price: **\$71,400.**

**K-25287L**

- 養生電腦馬桶組 (按鍵式)  
Health Mute intelligent toilets group  
List Price: **\$66,400.**

**K-2528W6**

- 瞬熱式電腦馬桶組  
In-line heater intelligent toilet  
List Price: **\$57,600.**

**K-2528B6**

- 單冷水潔身單體馬桶  
Cold water clean body monomer  
List Price: **\$43,600.**

產品尺寸

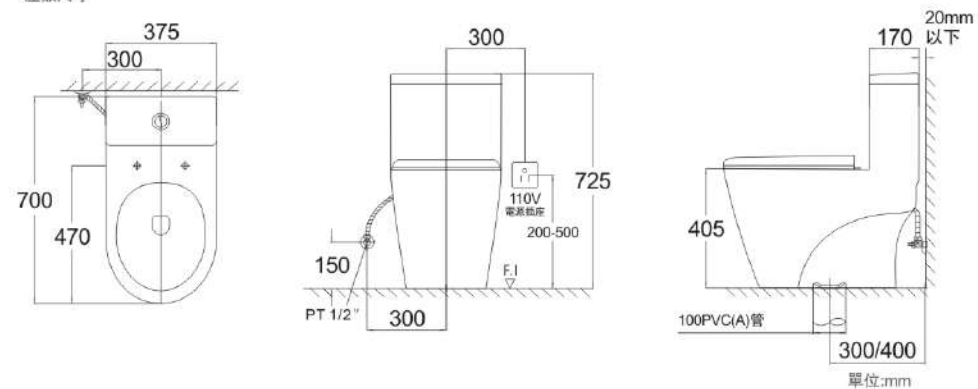

Yasz  
Suite 雅思套間

SUITES  
· 綜合系列 ·

029 030



多種管距 | 金級省水

· 雅思套間 ·

YASZ 雅思

**K-2581** (地排)

**K-2581P** (牆排)



- 正沖噴射虹吸式單體馬桶  
Positive flush siphonic jet monomer toilet  
Size: 700x362x790mm  
S-trap: 300/400mm Roughing-in (牆排)  
P-trap: 180mm Roughing-in (地排)  
60-220mm Roughing-in (牆排)  
適用水壓/water pressure available:  
0.3kgf/cm<sup>2</sup>-7.5kgf/cm<sup>2</sup>

List Price: **\$ 37,000.**



適裝電腦馬桶座

KL-990L



**K-25819L**

- 養生電腦馬桶組 (遙控式)  
Health Mute intelligent toilets group  
List Price: **\$69,600.**

KL-970L



**K-25817L**

- 養生電腦馬桶組 (按鍵式)  
Health Mute intelligent toilets group  
List Price: **\$64,600.**

KW-204



**K-2581W4**

- 瞬熱式電腦馬桶組  
In-line heater intelligent toilet  
List Price: **\$58,700.**

FB-104



**K-2581B4**

- 單冷水潔身單體馬桶  
Cold water clean body monomer  
List Price: **\$41,800.**

產品尺寸

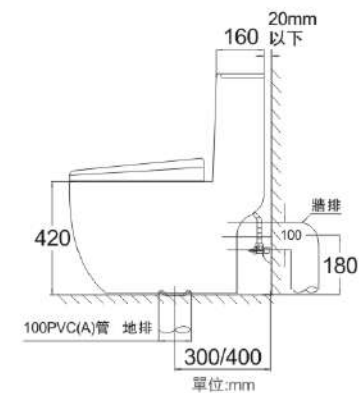
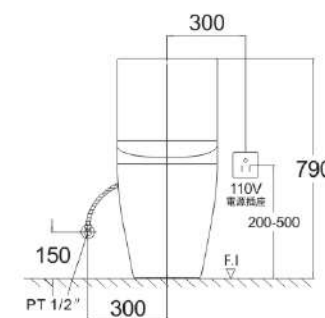
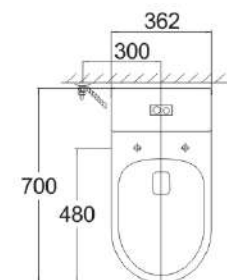

單位:mm

Jaimie  
Suite 傑米套間

SUITES  
· 綜合系列 ·

033 034



# 小馬桶大空間

創造更多空間、更多深度、更多衛浴享受！



JAIMIE 傑米  
**K-2571**

- 噴射虹吸式單體馬桶  
Siphonic jet monomer toilet  
Size: 660x375x760mm  
S-trap: 300/400mm Roughing-in  
適用水壓/water pressure available:  
0.3kgf/cm<sup>2</sup>—7.5kgf/cm<sup>2</sup>

List Price: **\$ 25,800.**



## 適裝電腦馬桶座



**K-25719S**

- 養生電腦馬桶組 (遙控式)  
Health Mute intelligent toilets group  
List Price: **\$58,800.**

**K-25717S**

- 養生電腦馬桶組 (按鍵式)  
Health Mute intelligent toilets group  
List Price: **\$53,800.**

**K-2571W6**

- 瞬熱式電腦馬桶組  
In-line heater intelligent toilet  
List Price: **\$45,000.**  
(馬桶尺寸偏小, 不建議搭配)

**K-2571B8**

- 單冷水潔身單體馬桶  
Cold water clean body monomer  
List Price: **\$31,000.**

## 產品尺寸

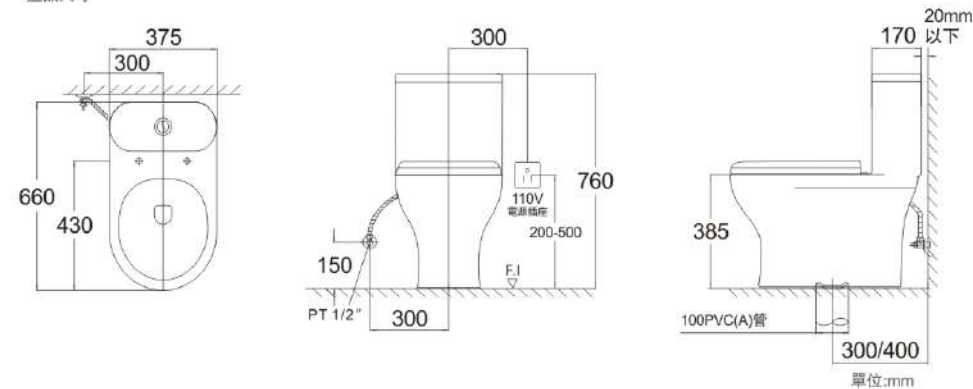



# Yali Suite 雅麗套間

SUITES  
· 綜合系列 ·

037 038





雙漩流設計 | 對抗堵塞 | 長效抗污



YALI 雅麗  
**K-2599**

雙漩流+大管徑

- 噴射虹吸式單體馬桶  
Positive flush siphonic jet monomer toilet  
Size: 700x390x780mm  
S-trap: 300/400mm Roughing-in  
適用水壓/water pressure available:  
0.3kgf/cm<sup>2</sup>~7.5kgf/cm<sup>2</sup>

List Price: **\$39,800.**



適裝電腦馬桶座



**K-25999L**

- 養生電腦馬桶組 (遙控式)  
Health Mute intelligent toilets group  
List Price: **\$72,400.**

**K-25997L**

- 養生電腦馬桶組 (按鍵式)  
Health Mute intelligent toilets group  
List Price: **\$67,400.**

**K-2599W6**

- 瞬熱式電腦馬桶組  
In-line heater intelligent toilet  
List Price: **\$587,600.**

**K-2599B6**

- 單冷水潔身單體馬桶  
Cold water clean body monomer  
List Price: **\$44,600.**

產品尺寸

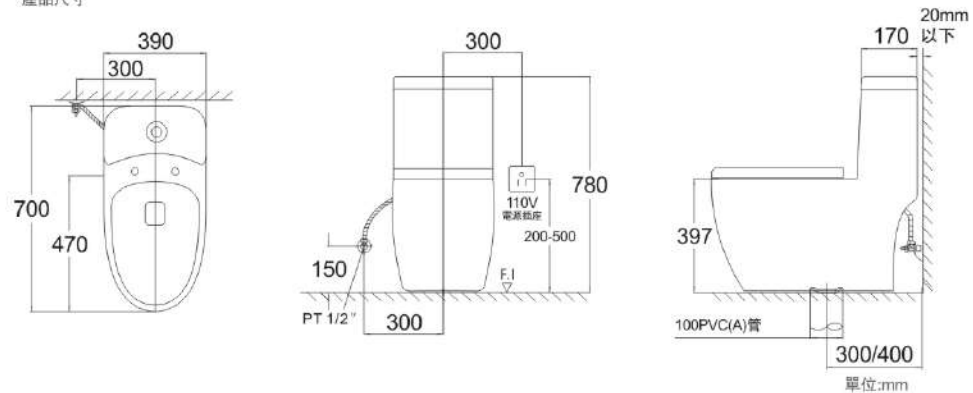

# Carry Suite 凱瑞套間

SUITES 041 042  
· 綜合系列 ·





Clean+  
奈潔技術

CARRY SUITE 043 044

· 凱瑞套間 ·



CARRY 凱瑞  
**K-2399**

訂

大管造

• 噴射虹吸式單體馬桶

Siphonic jet monomer toilet

Size: 700x370x680mm

S-trap: 300/400mm Roughing-in

適用水壓/water pressure available:

0.3kgf/cm<sup>2</sup>—7.5kgf/cm<sup>2</sup>

List Price: **\$29,800.**



適裝電腦馬桶座



**K-23999L**

• 養生靜音電腦馬桶組 (遙控式)  
Health Mute intelligent toilets group  
List Price: **\$62,400.**

**K-23997L**

• 養生靜音電腦馬桶組 (按鍵式)  
Health Mute intelligent toilets group  
List Price: **\$57,400.**

**K-2399W6**

• 瞬熱式電腦馬桶組  
In-line heater intelligent toilet  
List Price: **\$48,600.**

**K-2399B6**

• 單冷水潔身單體靜音馬桶  
Cold water clean body monomer  
List Price: **\$34,600.**

產品尺寸

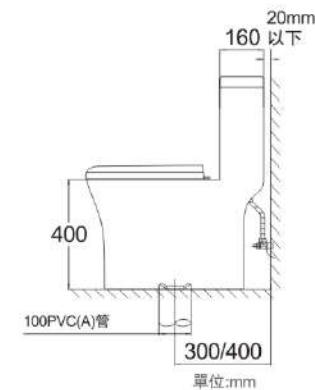
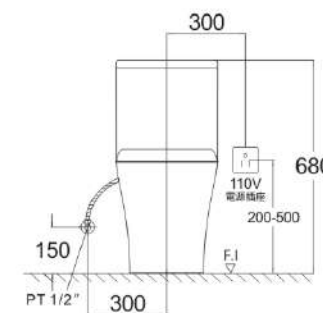
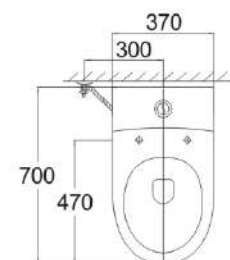

對抗堵塞 | 長效抗污 | 金級省水

單位:mm

# Jiebei Suite

潔蓓套間

SUITES

045 046

· 綜合系列 ·





對抗堵塞 | 長效抗污 | 金級省水

Clean+  
奈潔技術

JIEBEI SUITE 047 048  
· 潔蓓套間 ·



300mm安裝對準線  
400mm安裝對準線



JIEBEI 潔蓓  
**K-2596M**

大管道

- 噴射虹吸式單體馬桶  
Siphonic jet monomers toilet  
Size: 690x385x750mm  
S-trap: 300/400mm Roughing-in  
適用水壓/water pressure available:  
0.3kgf/cm<sup>2</sup>~7.5kgf/cm<sup>2</sup>

List Price: **\$28,000.**



適裝電腦馬桶座



**K-2596M9L**

- 養生電腦馬桶組 (遙控式)  
Health Mute intelligent toilets group  
List Price: **\$60,600.**

**K-2596M7L**

- 養生電腦馬桶組 (按鍵式)  
Health Mute intelligent toilets group  
List Price: **\$55,600.**

**K-2596MW6**

- 瞬熱式電腦馬桶組  
In-line heater intelligent toilet  
List Price: **\$46,800.**

**K-2596MB6**

- 單冷水潔身單體馬桶  
Cold water clean body monomer  
List Price: **\$32,800.**

產品尺寸

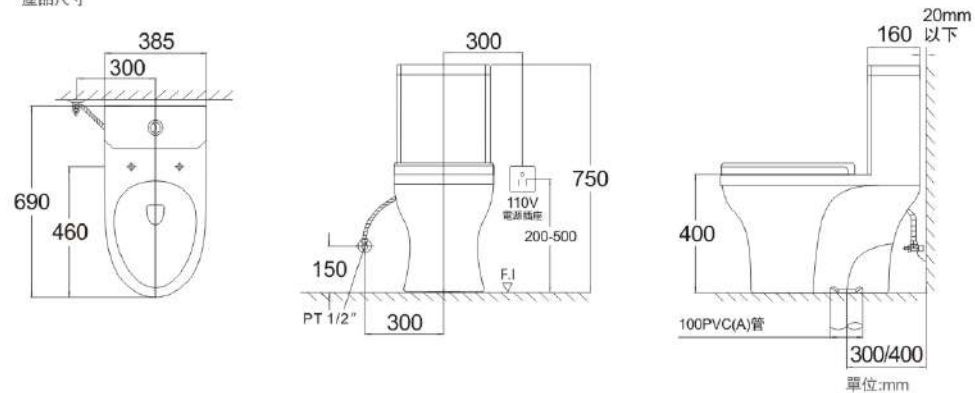

Jieyao  
Suite 潔瑤套間

SUITES

049 050

· 綜合系列 ·





對抗堵塞 | 長效抗污 | 金級省水

Clean+  
奈潔技術

JIEYAO SUITE

051 052

· 潔瑤套間 ·



JIEYAO 潔瑤  
**K-2896**

大管造

- 噴射虹吸式分體馬桶
- Siphonic jet monomers toilet
- Size: 690x385x780mm
- S-trap: 300/400mm Roughing-in
- 適用水壓/water pressure available:  
0.3kgf/cm<sup>2</sup> - 7.5kgf/cm<sup>2</sup>

List Price: **\$ 18,800.**



300mm安裝對準線  
400mm安裝對準線

適裝電腦馬桶座



**K-28969L**

- 養生電腦馬桶組 (遙控式)
- Health Mute intelligent toilets group
- List Price: **\$51,400.**

**K-28967L**

- 養生電腦馬桶組 (按鍵式)
- Health Mute intelligent toilets group
- List Price: **\$46,400.**

**K-2896W6**

- 瞬熱式電腦馬桶組
- In-line heater intelligent toilet
- List Price: **\$37,600.**

**K-2896B6**

- 單冷水潔身分體馬桶
- Cold water clean body monomer
- List Price: **\$23,600.**

產品尺寸

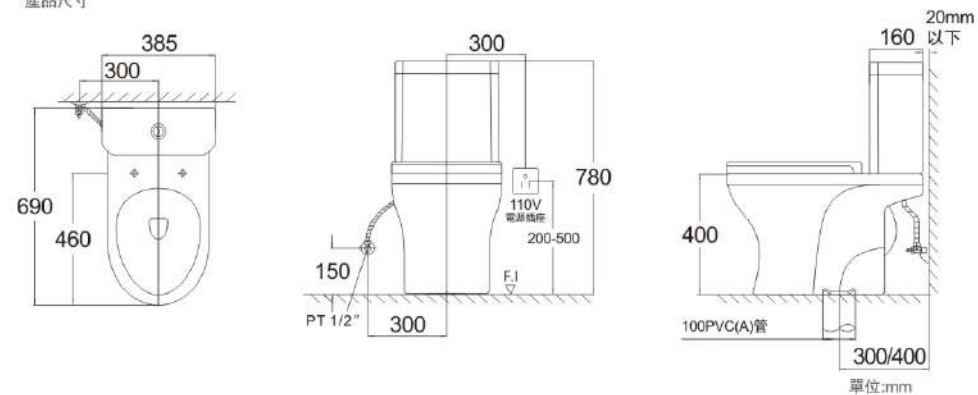



Jielin  
Suite 潔琳套間

SUITES  
· 綜合系列 ·

053 054





對抗堵塞 | 長效抗污 | 金級省水

Clean+  
奈潔技術

JIELIN SUITE 055 056

· 潔琳套間 ·



JIELIN 潔琳  
**K-2996**

大管道

- 噴射虹吸式分體馬桶  
Siphonic jet monomers toilet
- Size: 690x385x780mm
- S-trap: 300/400mm Roughing-in
- 適用水壓/water pressure available:  
0.3kgf/cm<sup>2</sup>—7.5kgf/cm<sup>2</sup>

List Price: **\$ 11,800.**



適裝電腦馬桶座



**K-29969L**

- 養生電腦馬桶組 (遙控式)  
Health Mute intelligent toilets group
- List Price: **\$45,600.**

**K-29967L**

- 養生電腦馬桶組 (按鍵式)  
Health Mute intelligent toilets group
- List Price: **\$40,600.**

**K-2996W6**

- 瞬熱式電腦馬桶組  
In-line heater intelligent toilet
- List Price: **\$31,800.**

**K-2996B6**

- 單冷水潔身分體馬桶  
Cold water clean body monomer
- List Price: **\$17,800.**

產品尺寸

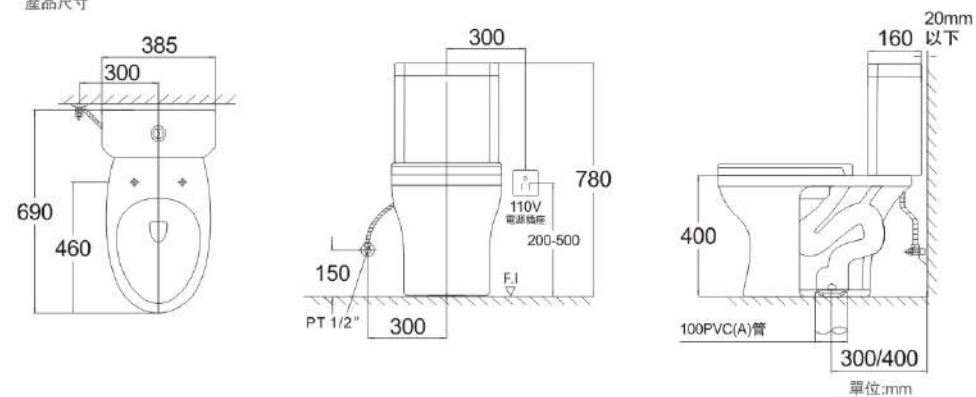



對抗堵塞 | 長效抗污 | 金級省水



300mm安裝對準線  
400mm安裝對準線



JIELE 潔樂  
K-2580M

大管道

- 噴射虹吸式單體馬桶
- Siphonic jet monomers toilet
- Size: 690x385x750mm
- S-trap: 300/400mm Roughing-in
- 適用水壓/water pressure available:  
0.3kg/cm<sup>2</sup>~7.5kg/cm<sup>2</sup>
- List Price: **\$ 28,000.**

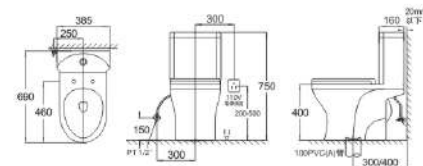

300mm安裝對準線  
400mm安裝對準線



JIEHAO 潔好  
K-2880

大管道

- 噴射虹吸式分體馬桶
- Siphonic jet monomers toilet
- Size: 690x385x780mm
- S-trap: 300/400mm Roughing-in
- 適用水壓/water pressure available:  
0.3kg/cm<sup>2</sup>~7.5kg/cm<sup>2</sup>
- List Price: **\$ 18,800.**

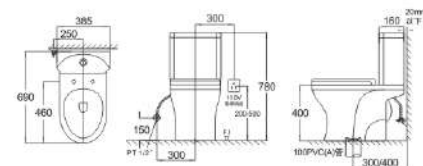

300mm安裝對準線  
400mm安裝對準線



JIEWAN 潔旺  
K-2980

大管道

- 噴射虹吸式分體馬桶
- Siphonic jet monomers toilet
- Size: 690x385x780mm
- S-trap: 300/400mm Roughing-in
- 適用水壓/water pressure available:  
0.3kg/cm<sup>2</sup>~7.5kg/cm<sup>2</sup>
- List Price: **\$ 11,800.**

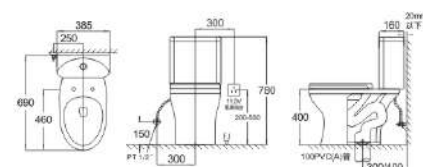

單位:mm



# Haitang Suite 海棠套間

SUITES 059 060

· 綜合系列 ·





HAITANG 海棠  
**K-5558**

- 直冲式落地馬桶  
Wash down toilet  
Size: 540x370x390mm  
S-trap: 300/400mm Roughing-in  
適用水壓/water pressure available:  
0.3kgf/cm<sup>2</sup>—7.5kgf/cm<sup>2</sup>

List Price: **\$ 22,000.**



注: K-5558、K-5458均為無水箱馬桶必須再搭配隱藏式水箱或快沖閘, 方可使用。

適裝電腦馬桶座



**K-55589L**

- 養生靜音電腦馬桶組 (遙控式)  
Health Mute intelligent toilets group  
List Price: **\$54,600.**

**K-55587L**

- 養生靜音電腦馬桶組 (按鍵式)  
Health Mute intelligent toilets group  
List Price: **\$49,600.**

**K-5558W6**

- 瞬熱式電腦馬桶組  
In-line heater intelligent toilet  
List Price: **\$40,800.**

**K-5558B6**

- 單冷水潔身單靜音馬桶  
Cold water clean body monomer  
List Price: **\$26,800.**

產品尺寸

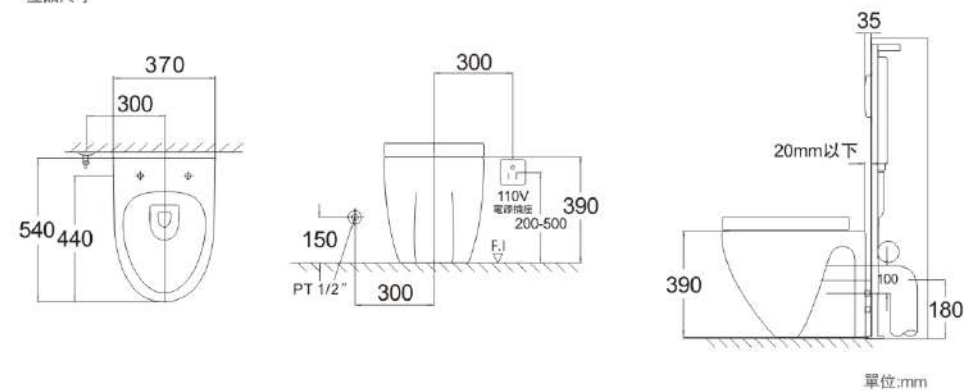

# Haitang Suite

海棠套間

SUITES 063 064

· 綜合系列 ·





HAITANG 海棠  
**K-5458**

- 雙噴龍捲(直沖式)懸壁式馬桶  
Hanging wall toilet  
Size: 530x370x360mm  
P-trap: 180mm Roughing-in  
適用水壓/water pressure available:  
0.3kgf/cm<sup>2</sup>—7.5kgf/cm<sup>2</sup>

List Price: **\$ 19,800.**



注: K-5558、K-5458均為無水箱馬桶必須再搭配隱藏式水箱或快沖閥, 方可使用。

適裝電腦馬桶座



**K-54589L**

- 養生靜音電腦馬桶組 (遙控式)  
Health Mute intelligent toilets group  
List Price: **\$52,400.**

**K-54587L**

- 養生靜音電腦馬桶組 (按鍵式)  
Health Mute intelligent toilets group  
List Price: **\$47,400.**

**K-5458W6**

- 瞬熱式電腦馬桶組  
In-line heater intelligent toilet  
List Price: **\$38,600.**

**K-5458B6**

- 單冷水潔身單體靜音馬桶  
Cold water clean body monomer  
List Price: **\$24,600.**

產品尺寸

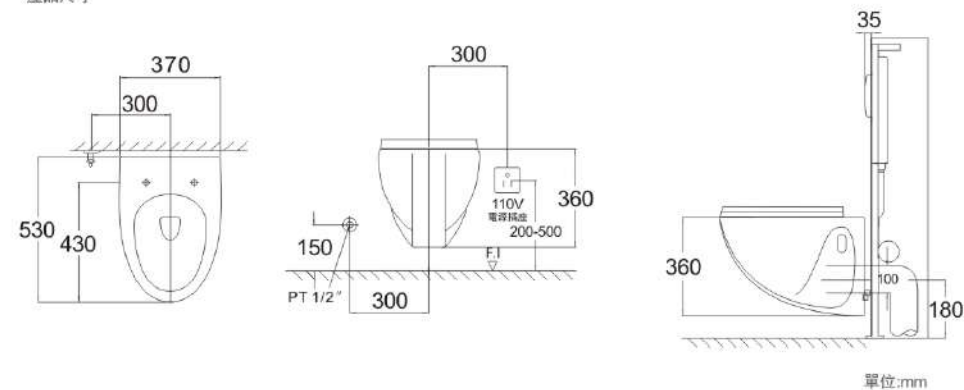

單位:mm

沖水按鈕

水箱

支架

進水管

管夾

排污管

地盤

二級式沖水，節約用水資源  
(按鈕可選擇正裝及頂裝)

內部進排水器拆裝便捷，  
便於日後維修清洗。

EPS外保護層，可有效減少  
噪音，並起隔熱作用，防  
止夏天結露。

二組懸壁式馬桶安裝孔，適配  
於兩層多種馬桶。(亦可配  
合大多數懸壁式馬桶)

排水管管固定管夾可上下調  
節，可適用掛排水落地式馬  
桶(K-5575)安裝要求。

安裝機架高度高低可調節，  
可配合不同地磚或大理石  
材等不同鋪材厚度。

本產品可頂裝安裝

• 隱藏式水箱 (可正壓及上壓)  
**K-5723-K-5728**  
Concealed cistern  
Size: 500x167x820mm  
**K-201A** 隱藏式水箱 (含零件) \$ 15,800.  
**K-8041** 鐵架 (不含面板) \$ 6,900.  
適用3-8號面板

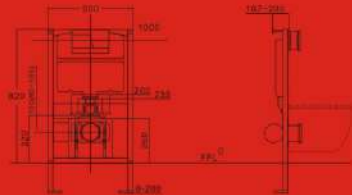

無論是設計新穎的外形，還是簡潔時尚的風格，都彰顯您個性的最佳選擇，衛浴生活新態度的詮釋。晶瑩剔透的白，光滑的質感，如絲滑般親吻肌膚。如此契合的承載，體現生活的本質。舒適。不及言語。



• 隱藏式水箱  
**K-5713-K-5718**  
Concealed cistern  
Size: 500x147x1140mm  
**K-130** 隱藏式水箱 (含零件) \$ 14,200.  
**K-8016** 鐵架 (不含面板) \$ 6,200.

適用3-8號面板

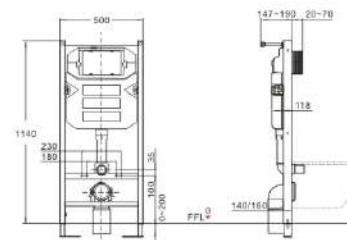

• 隱藏式水箱  
**K-5713-K-5718**  
Concealed cistern  
Size: 500x135x1185mm  
**K-101B** 隱藏式水箱 (含零件) \$ 14,200.  
**K-8014** 鐵架 (不含面板) \$ 6,200.

適用3-8號面板

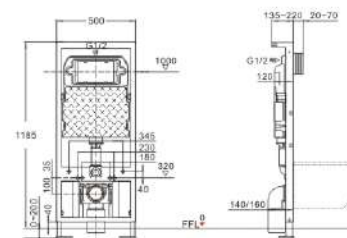

本產品可頂裝安裝

(可正壓及上壓)

• 隱藏式水箱  
**K-5723-K-5728**  
Concealed cistern  
Size: 500x167x820mm  
**K-201B** 隱藏式水箱 (含零件) \$ 15,800.  
**K-8044** 鐵架 (不含面板) \$ 6,900.

適用3-8號面板

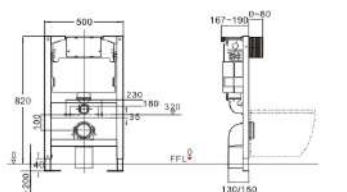

影高板



• 隱藏式水箱  
**K-5733-K-5738**  
Concealed cistern  
Size: 580x90x1140mm  
**K-301A** 隱藏式水箱 (含零件) \$ 15,800.  
**K-8310** 鐵架 (不含面板) \$ 6,900.

超厚方形管 (管壁厚度1.2mm,  
可承重800公斤以上掛式馬桶。)

適用3-8號面板

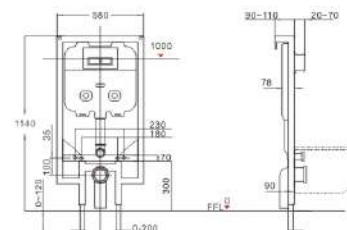

PANELS 隱藏式水箱用按鍵系列 (面板可以自由搭配各款隱藏式水箱)



- K-5131-3** 期  
• 前按雙沖水 (霧黑)  
List Price: \$ 3,000.
- K-5131-4**  
• 前按雙沖水 (霧銀)  
List Price: \$ 3,000.
- K-5131-5** 期  
• 前按雙沖水 (亮白)  
List Price: \$ 2,800.
- K-5034-6** 期  
• 前按雙沖水 (亮白)  
List Price: \$ 2,800.
- K-5034-7**  
• 前按雙沖水 (霧銀)  
List Price: \$ 3,000.
- K-5130-8**  
• 前按雙沖水 (霧銀)  
List Price: \$ 3,200.



# Public Area Products 公共套間



經典系列移植異國風情，展現結合異國民族特色及精緻文化品味相結合的設計特色，  
帶著充滿自然、陽光的絢麗風情和魔幻奢華感受。



BP

HARDY 哈帝  
**K-3643BP+KA-521**

- **K-3643BP** 掛式小便斗  
Wall-hung urinal  
Size: 350x395x750mm  
Washing System:背進背出水  
List Price: **¥ 12,000.**
- **KA-521** 內置陶瓷式感應器  
Concealed Urinal Sensor  
Size: 36x36x32mm  
List Price: **¥ 9,800.**

合計: **¥ 21,800.**

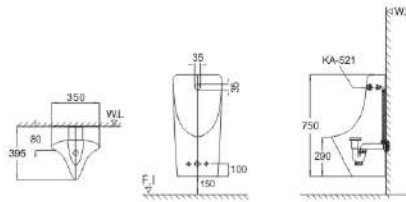

BS

HARDY 哈帝  
**K-3643BS+KA-521**

- **K-3643BS** 掛式小便斗  
Wall-hung urinal  
Size: 350x395x750mm  
Washing System:背進地排水  
List Price: **¥ 12,000.**
- **KA-521** 內置陶瓷式感應器  
Concealed Urinal Sensor  
Size: 36x36x32mm  
List Price: **¥ 9,800.**

合計: **¥ 21,800.**

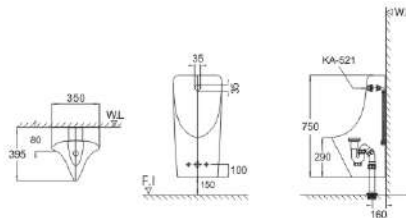

US

表示上進水地排水

UP

表示上進水牆排水

BS

表示牆進水地排水

BP

表示牆進水牆排水

UP

HARDY 哈帝  
**K-3643UP+KA-501+KA-111**

- **K-3643UP** 掛式小便斗  
Wall-hung urinal  
Size: 350x395x750mm  
Washing System:上進背出水  
List Price: **¥ 12,000.**
- **KA-501** 灑水器  
Sprinkler  
List Price: **¥ 1,200.**
- **KA-111** 外露式感應器  
Exposed Urinal Sensor  
Size: 225x125x135mm  
List Price: **¥ 8,000.**

合計: **¥ 21,200.**

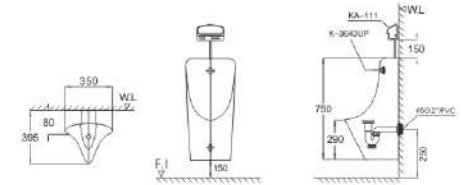

US

HARDY 哈帝  
**K-3643US+KA-501+KA-111**

- **K-3643US** 掛式小便斗  
Wall-hung urinal  
Size: 350x395x750mm  
Washing System:上進地排水  
List Price: **¥ 12,000.**
- **KA-501** 灑水器  
Sprinkler  
List Price: **¥ 1,200.**
- **KA-111** 外露式感應器  
Exposed Urinal Sensor  
Size: 225x125x135mm  
List Price: **¥ 8,000.**

合計: **¥ 21,200.**

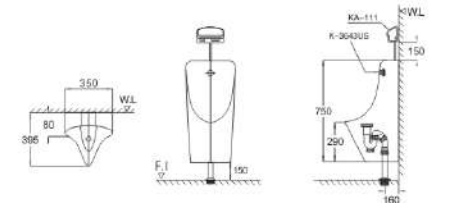

BP

HARDY 哈帝  
**K-3643BP+KA-211**

- **K-3643BP** 掛式小便斗  
Wall-hung urinal  
Size: 350x395x750mm  
Washing System:背進背出水  
List Price: **¥ 12,000.**
- **KA-501** 灑水器  
Sprinkler  
List Price: **¥ 1,200.**
- **KA-211** 嵌牆式感應器  
Automatic Urinal Sensor  
Size: 220x82x125mm  
List Price: **¥ 11,000.**

合計: **¥ 24,200.**

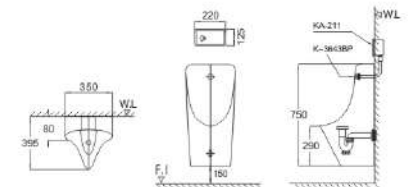

BS

HARDY 哈帝  
**K-3643BS+KA-311**

- **K-3643BS** 掛式小便斗  
Wall-hung urinal  
Size: 350x395x750mm  
Washing System:背進地排水  
List Price: **¥ 12,000.**
- **KA-501** 灑水器  
Sprinkler  
List Price: **¥ 1,200.**
- **KA-311** 嵌牆式感應器  
Automatic Urinal Sensor  
Size: 147x93x147mm  
List Price: **¥ 11,000.**

合計: **¥ 24,200.**

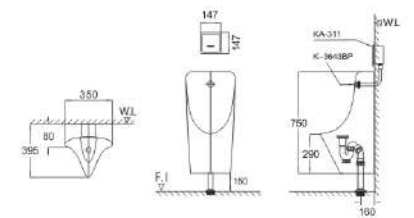



BP

ANBEI 安蓓  
K-3652N+KA-511

• **K-3652N** 掛式小便斗  
Wall-hung urinal  
Size: 330x320x630mm  
Washing System: 背進背出水  
List Price: **\$ 22,000.**

• **KA-511** 內置陶瓷式感應器  
Concealed Urinal Sensor  
Size: 50x50x32mm  
List Price: **\$ 11,500.**

合計: **\$ 33,500.**

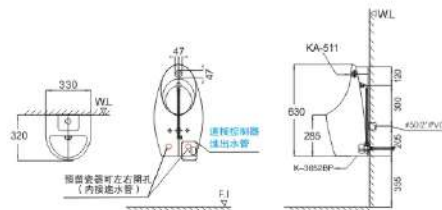

US

RUEIKE 芮可  
K-3111NI+KA-510

• **K-3111NI** 立式小便斗  
Stand urinal  
Size: 445x375x1000mm  
Washing System: 背進地排水  
List Price: **\$ 18,000.**

• **KA-510** 內嵌式感應器  
Concealed Urinal Sensor  
List Price: **\$ 11,500.**

合計: **\$ 29,500.**

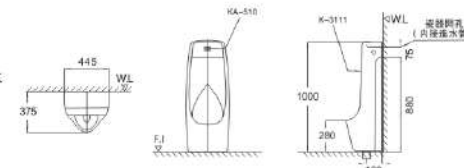

UP

ALDEN 愛爾頓  
K-3658ZUP+KA-111

• **K-3658ZUP** 掛式小便斗  
Wall-hung urinal  
Size: 335x295x685mm  
Washing System: 上進背出水  
List Price: **\$ 8,000.**

• **KA-111** 外露式感應器  
Exposed Urinal Sensor  
Size: 225x125x135mm  
List Price: **\$ 8,000.**

合計: **\$ 16,000.**

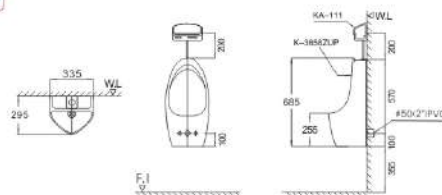

US

MAJI 麻吉  
K-3119US+KA-111

• **K-3119US** 立式小便斗  
Stand urinal  
Size: 385x340x870mm  
Washing System: 上進地排水  
List Price: **\$ 18,000.**

• **KA-111** 外露式感應器  
Exposed Urinal Sensor  
Size: 225x125x135mm  
List Price: **\$ 8,000.**

合計: **\$ 26,000.**

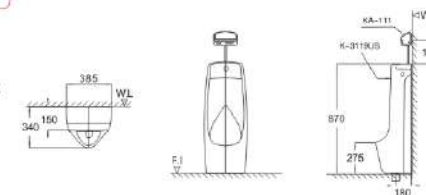

BP

ALDEN 愛爾頓  
K-3658ZBP+KA-211

• **K-3658ZBP** 掛式小便斗  
Wall-hung urinal  
Size: 335x295x685mm  
Washing System: 背進背出水  
List Price: **\$ 8,000.**

• **KA-211** 嵌牆式感應器  
Automatic Urinal Sensor  
Size: 220x82x125mm  
List Price: **\$ 11,000.**

合計: **\$ 19,000.**

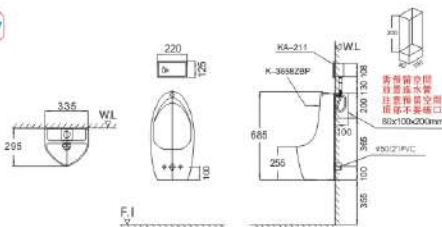

UP

US

MAJI 麻吉  
K-3641US+KA-111

• **K-3641US** 掛式小便斗  
Wall-hung urinal  
Size: 330x320x495mm  
Washing System: 上進水  
List Price: **\$ 6,800.**

• **KA-111** 外露式感應器  
Exposed Urinal Sensor  
Size: 225x125x135mm  
List Price: **\$ 8,000.**

合計: **\$ 14,800.**

贈排地排兩用式

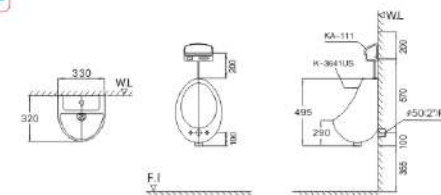

註明 “不含排水零件”



BP

ALDEN 愛爾頓  
K-3658ZBP+KA-311

• **K-3658ZBP** 掛式小便斗  
Wall-hung urinal  
Size: 335x295x685mm  
Washing System: 背進背出水  
List Price: **\$ 8,000.**

• **KA-311** 嵌牆式感應器  
Automatic Urinal Sensor  
Size: 147x93x147mm  
List Price: **\$ 11,000.**

合計: **\$ 19,000.**

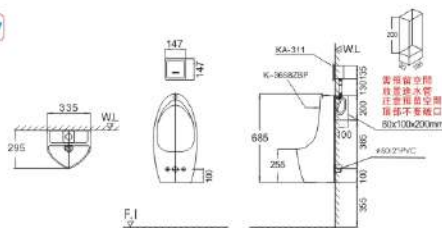



FUSANG 美桑  
**K-3919**

- 擋板 (小便斗隔板)  
Bottle plate  
Size: 400x100x810mm  
List Price: **\$ 7,000.** (空瓷器)

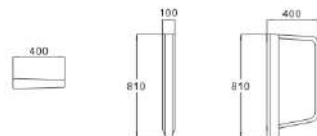

- KA-521** (交流電)
- 內置陶瓷式灑水感應器  
Sprinkler  
Size: 50x50x32mm  
List Price: **\$ 9,800.**



- KA-501** (直流電)
- 需搭配碳精式感應器  
灑水器  
Sprinkler  
Size: 50x50x32mm  
List Price: **\$ 1,200.**



- KA-510** (交流電)  
**KA-510DC** (直流電)
- 內置陶瓷式感應器  
Concealed Ultral Sensor  
Size: 80x18x46mm  
List Price: **\$ 11,500.**



- KA-511** (交流電)  
**KA-511DC** (直流電)
- 內置陶瓷式感應器  
Concealed Ultral Sensor  
Size: 50x50x32mm  
List Price: **\$ 11,500.**



- KA-111** 
- 外露式便斗感應器  
Exposed Ultral Sensor  
Size: 225x125x135mm  
List Price: **\$ 8,000.**

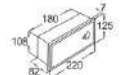

- KA-211** 
- 嵌牆式便斗感應器  
Automatic Ultral Sensor  
Size: 220x82x125mm  
List Price: **\$ 11,000.**



- KA-311** 
- 嵌牆式便斗感應器  
Automatic Ultral Sensor  
Size: 147x93x147mm  
List Price: **\$ 11,000.**

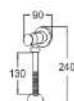

- SH-02** 
- 手壓便斗沖水器  
Ultral Flush Valve  
Size: 240x90mm  
List Price: **\$ 2,800.**





期 IDA 愛達  
**K-2523L+K-2074**

• 蹲便+水箱  
Squatting pan w.c.  
Size: 700x270x415mm  
Build-in platform  
List Price: **\$ 7,600.+ \$ 4,000.**



合計: **\$ 11,600.**

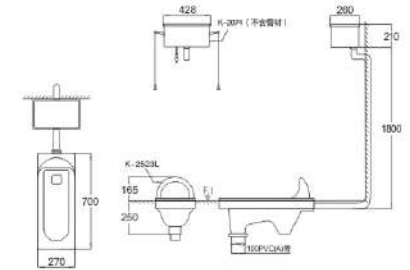

期 IDA 愛達  
**K-2523L+K-2075**

• 蹲便+水箱  
Squatting pan w.c.  
Size: 700x270x415mm  
Build-in platform  
List Price: **\$ 7,600.+ \$ 5,200.**

合計: **\$ 12,800.**

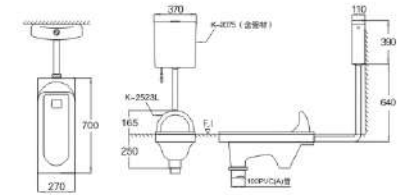

IDA 愛達  
**K-2523L+DK-333**

• 蹲便+二段式快沖  
Squatting pan w.c.  
Size: 700x270x415mm  
Build-in platform  
適用水壓範圍:1-5kgf/cm<sup>2</sup>  
(需在壓力1-2.5kgf/cm<sup>2</sup>動壓進水條件下)  
List Price: **\$ 7,600.+ \$ 9,000.**

合計: **\$ 16,600.**

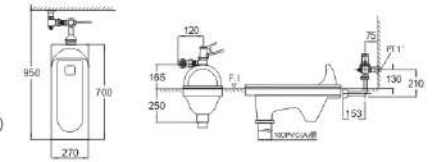

IDA 愛達  
**K-2523L+DK-322**

• 蹲便+二段式快沖  
Squatting pan w.c.  
Size: 700x270x415mm  
Build-in platform  
適用水壓範圍:1-5kgf/cm<sup>2</sup>  
(需在壓力1-2.5kgf/cm<sup>2</sup>動壓進水條件下)  
List Price: **\$ 7,600.+ \$ 9,000.**

合計: **\$ 16,600.**

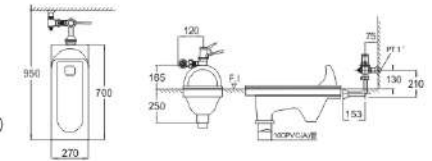

IDA 愛達  
**K-2523L+DK-2221**

• 蹲便+感應沖水  
Squatting pan w.c.  
Size: 700x270x415mm  
Build-in platform  
List Price: **\$ 7,600.+ \$ 22,000.**

合計: **\$ 29,600.**

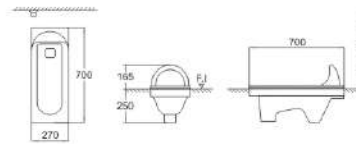

UT工程

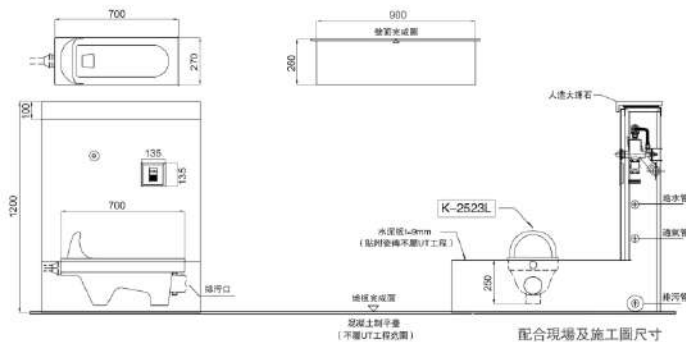

配合現場及施工圖尺寸

ICLEAN 麗潔  
**K-1620M (不含龍頭)**  
 • 方形連體盆  
 Square one-piece basin  
 Size: 480x480x840mm  
 Fixing to wall with back  
 List Price: **\$ 52,000.**

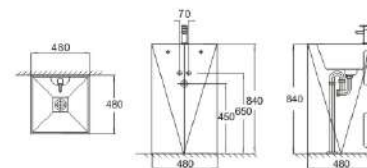

ICLEAN 麗潔  
**K-1630 (不含龍頭)**  
 • 圓形連體盆  
 Round one-piece basin  
 Size: 495x495x840mm  
 Fixing to wall with back  
 List Price: **\$ 35,000.**

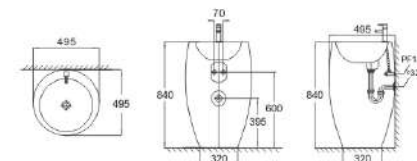

ICLEAN 麗潔  
**K-1690 (不含龍頭)**  
 • 方形連體盆  
 Square one-piece basin  
 Size: 500x445x840mm  
 Fixing to wall with back  
 List Price: **\$ 35,000.**

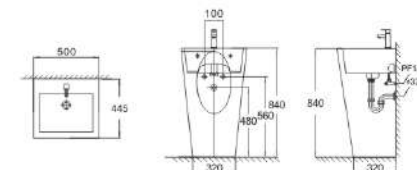

ICLEAN 麗潔  
**K-1640 (不含龍頭)**  
 • 連體盆  
 One-piece basin  
 Size: 540x480x880mm  
 Fixing to wall with back  
 List Price: **\$ 49,000.**

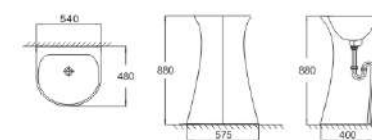



JIENI 潔妮  
**K-1135 (不含龍頭)**

• 連體盆  
Siamese basin  
Size: 560x500x385mm  
capacity: 5.1ml  
List Price: **\$ 12,800.**

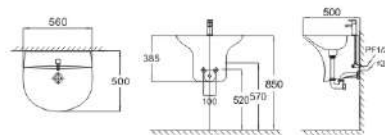

NIKE 尼克  
**K-1136+K-1037 (不含龍頭)**

• 長柱盆  
Long pedestal basin  
Size: 525x455x815mm  
capacity: 5.1ml  
List Price: 盆 **\$ 4,600.**長柱 **\$ 3,200.**

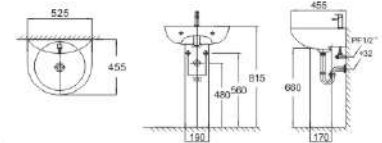

合計: **\$ 7,800.**



NIKE 尼克  
**K-1136+K-1536 (不含龍頭)**

• 短柱盆  
Short pedestal basin  
Size: 525x455x530mm  
capacity: 5.1ml  
List Price: 盆 **\$ 4,600.**短柱 **\$ 3,200.**

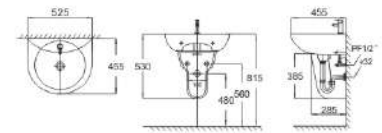

合計: **\$ 7,800.**



MAJI 麻吉  
**K-1137+K-1037 (不含龍頭)**

• 長柱盆  
Long pedestal basin  
Size: 556x470x815mm  
capacity: 7.2ml  
List Price: 盆 **\$ 4,600.**長柱 **\$ 3,200.**

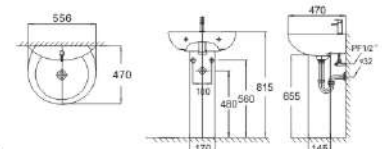

合計: **\$ 7,800.**



MAJI 麻吉  
**K-1137+K-1536 (不含龍頭)**

• 短柱盆  
Short pedestal basin  
Size: 556x470x545mm  
capacity: 7.2ml  
List Price: 盆 **\$ 4,600.**短柱 **\$ 3,200.**

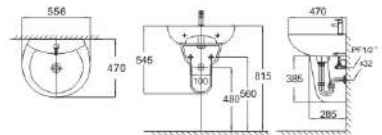

合計: **\$ 7,800.**

此浴櫃可搭配 **KARAT** 46公分寬以內藝術盆:



KC-137  
單門浴櫃

浴櫃顏色以實品為準



• 除霧明鏡 MB-4713  
Defogging mirror  
Size: 600x600mm  
List Price: **\$ 3,500.**

• 實木防水浴櫃 KC-137 (不含龍頭)  
Waterproof bathroom cabinet  
Size: 550x465x500mm  
List Price: **\$ 24,800.**

• 岩鑄石(霧面) KR-137CF  
List Price: **\$ 9,300.**

合計: **\$ 37,600.**

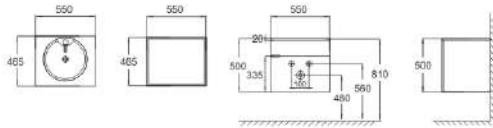

IRIS 艾瑞絲  
**K-1447N**

• 藝術盆 (不含龍頭)  
Artistic basin  
Size: 400x330x145mm  
Above counter mounting  
List Price: **\$ 6,500.**

可搭配K-137浴櫃

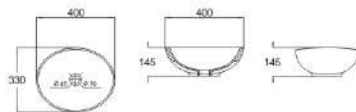

SHANTI 山巒  
**K-1904F** (不含龍頭)

• 藝術盆  
Artistic basin  
Size: 460x465x165mm  
Above counter mounting  
List Price: **\$ 6,800.**

可搭配KC-137浴櫃

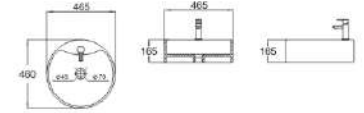

TSAIDIE 彩蝶  
**K-1975** (不含龍頭)

• 藝術盆  
Artistic basin  
Size: 470x385x160mm  
Above counter mounting  
List Price: **\$ 6,800.**

可搭配KC-137浴櫃

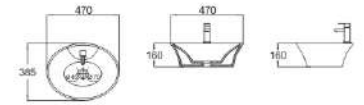

HUAYANG 華漾  
**K-1907F** (不含龍頭)

• 藝術盆  
Artistic basin  
Size: 430x430x175mm  
Above counter mounting  
List Price: **\$ 5,600.**

可搭配KC-137浴櫃

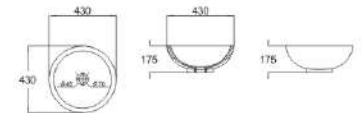

YIDIE 依蝶  
**K-1974F** (不含龍頭)

• 藝術盆  
Artistic basin  
Size: 435x435x165mm  
Above counter mounting  
List Price: **\$ 6,900.**

可搭配KC-137浴櫃

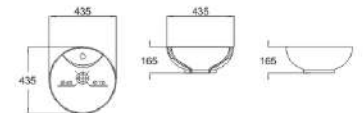





TAILESZ 泰樂絲  
K-1934F

- 藝術盆 (不含龍頭)
- Artistic basin
- Size: 525x415x165mm
- Above counter mounting
- List Price: **\$ 8,000.**

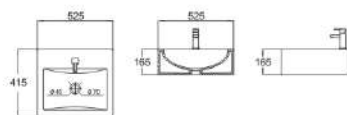

可搭配KC-934浴櫃



AIWEIER 艾薇爾  
K-1914F

- 藝術盆 (不含龍頭)
- Artistic basin
- Size: 530x430x160mm
- Above counter mounting
- List Price: **\$ 8,500.**

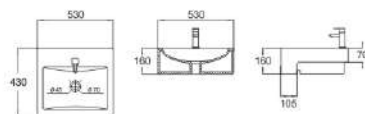

HUAGE 華格  
K-1922

- 藝術盆 (不含龍頭)
- Artistic basin
- Size: 445x360x130mm
- Above counter mounting
- List Price: **\$ 6,800.**

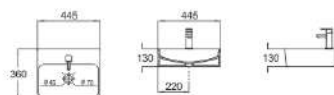

可搭配K-137浴櫃



DIAU 迪奧  
K-1962

- 藝術盆 (不含龍頭)
- Artistic basin
- Size: 630x390x115mm
- Above counter mounting
- List Price: **\$ 8,800.**

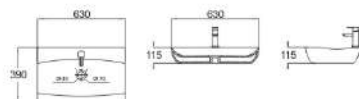

JABO 賈伯  
K-1903F (不含龍頭)

- 藝術盆
- Artistic basin
- Size: 450x450x110mm
- Above counter mounting
- List Price: **\$ 6,800.**

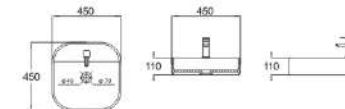

JACOB 雅路  
K-1923 (不含龍頭)

- 藝術盆
- Artistic basin
- Size: 610x450x110mm
- Above counter mounting
- List Price: **\$ 7,500.**

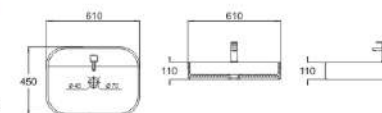



YOULI 尤莉  
K-1998 (不含龍頭)

- 藝術盆  
Artistic basin  
Size: 395x395x115mm  
Above counter mounting  
List Price: **\$ 5,600.**

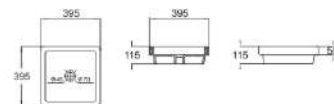

可搭配K-137浴櫃



BULAGE 布拉格  
K-1925

- 藝術盆 (不含龍頭)  
Artistic basin  
Size: 450x450x130mm  
Above counter mounting  
List Price: **\$ 6,600.**

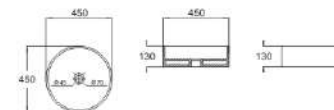

可搭配K-137浴櫃



RUINA 瑞娜  
K-1937

- 藝術盆 (不含龍頭)  
Artistic basin  
Size: 430x430x125mm  
Above counter mounting  
List Price: **\$ 7,500.**

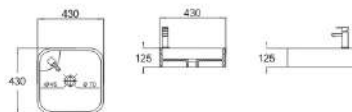

可搭配K-137浴櫃



LUOLUENSZ 羅倫斯  
K-1965F (不含龍頭)

- 藝術盆  
Artistic basin  
Size: 480x370x130mm  
Above counter mounting  
List Price: **\$ 8,000.**

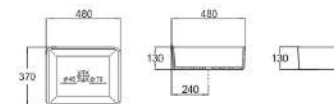

可搭配K-137浴櫃



RUIXI 瑞西  
K-1946

- 藝術盆 (不含龍頭)  
Artistic basin  
Size: 480x380x130mm  
Above counter mounting  
List Price: **\$ 9,000.**

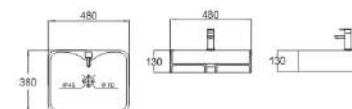

可搭配K-137浴櫃



OULEI 歐雷  
K-1405

- 藝術盆 (不含龍頭)  
Artistic basin  
Size: 445x445x140mm  
Above counter mounting  
List Price: **\$ 6,600.**

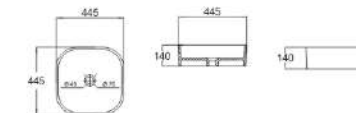

可搭配K-137浴櫃



OUXIANG 歐香  
K-1413

- 藝術盆 (不含龍頭)  
Artistic basin  
Size: 465x320x135mm  
Above counter mounting  
List Price: **\$ 7,500.**

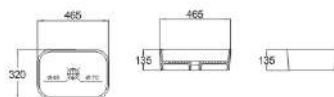

可搭配K-137浴櫃



OUGE 歐格  
K-1409

- 藝術盆 (不含龍頭)  
Artistic basin  
Size: 510x400x135mm  
Above counter mounting  
List Price: **\$ 8,000.**

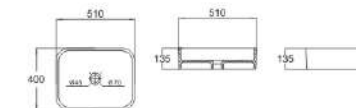

可搭配K-137浴櫃



OUFU 歐芙  
K-1438

- 藝術盆 (不含龍頭)
- Artistic basin
- Size: 590x400x150mm
- Above counter mounting
- List Price: **\$ 8,800.**

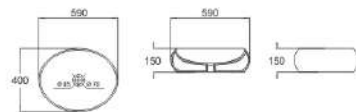

可搭配K-137浴櫃



BEILANG 貝朗  
K-1133

- 藝術盆 (不含龍頭)
- Artistic basin
- Size: 380x380x160mm
- Above counter mounting
- List Price: **\$ 9,100.**

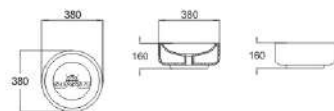

可搭配K-137浴櫃



BEIYA 貝亞  
K-1134

- 藝術盆 (不含龍頭)
- Artistic basin
- Size: 400x400x160mm
- Above counter mounting
- List Price: **\$ 9,100.**

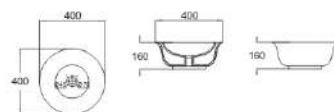

可搭配K-137浴櫃

現代潔具的特點是實用、簡潔，即使是新古典主義風格也是運用簡潔的古典元素進行設計，或者汲取古典設計的精華與現代設計理念進行整合。



KATIYA 卡提亞  
K-1356 (不含龍頭)

- 臺上盆
- Counter-top basin
- Size: 515x450x190mm
- Above counter mounting
- List Price: **\$ 6,500.**

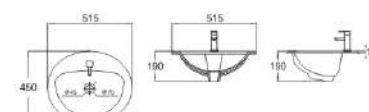

AIMILI 愛蜜莉  
K-1383 (不含龍頭)

- 臺上盆
- Counter-top basin
- Size: 410x410x175mm
- Above counter mounting
- List Price: **\$ 7,800.**

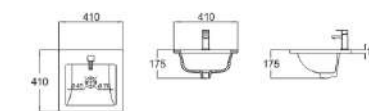



K-1569

TERESA 特瑞沙  
K-1539

- 臺下盆 (不含龍頭)  
Under counter basin  
Size: 600x380x170mm  
Under counter mounting  
List Price: **\$ 7,800.** (不含掛件)

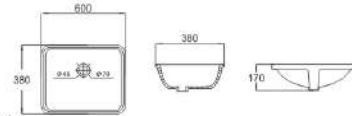

SYLVIA 西維亞  
K-1580

- 臺下盆 (不含龍頭)  
Under counter basin  
Size: 455x460x170mm  
Under counter mounting  
List Price: **\$ 4,000.** (不含掛件)



YADU 亞都  
K-1599F (K-1571)

- 臺下盆 (不含龍頭)  
Under counter basin  
Size: 565x430x195mm  
Under counter mounting  
List Price: **\$ 5,600.** (不含掛件)

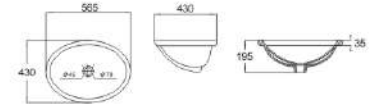

AILANNA 愛蘭娜  
K-1568

- 臺下盆 (不含龍頭)  
Under counter basin  
Size: 550x400x175mm  
Under counter mounting  
List Price: **\$ 8,000.** (不含掛件)

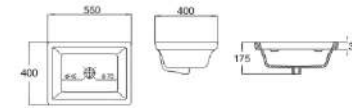

LEIWANA 蕾瓦娜  
K-1598F (K-1572)

- 臺下盆 (不含龍頭)  
Under counter basin  
Size: 490x400x195mm  
Under counter mounting  
List Price: **\$ 4,800.** (不含掛件)

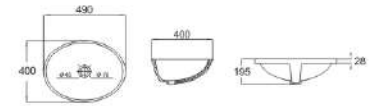

AIFEIER 愛菲爾  
K-1569

- 臺下盆 (不含龍頭)  
Under counter basin  
Size: 545x345x175mm  
Under counter mounting  
List Price: **\$ 7,600.** (不含掛件)

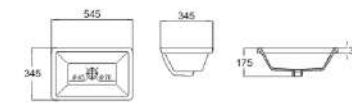

KASHAWA 卡莎瓦  
K-1501

- 臺下盆 (不含龍頭)  
Under counter basin  
Size: 430x430x165mm  
Under counter mounting  
List Price: **\$ 4,800.** (不含掛件)





Bathroom Furniture  
浴櫃

不銹鋼鉸鏈

100%防水



PVC浴櫃擁有世界一流的品質，100%鉸鏈防水效果，不生鏽、不腐爛。



其它品牌鉸鏈 (金屬易生鏽)



浴櫃特點 The characters of the Bathroom cabinet



洗臉盆

陶瓷盆通過1280度高溫鍛燒，盆體堅固、不吸水、耐刮、耐熱，色澤渾厚，吸水率低。採用進口釉料，表面光潔，造型多樣，時尚簡潔。



100%防水不銹鋼門鉸鏈

不銹鋼門鉸鏈及隱藏型尼，使用壽命長久、工藝精細，有效降低開門噪音。



不銹鋼自攻螺絲 / 不銹鋼膠圈螺絲

原壓零件皆採用不銹鋼材質，保障安全性。

注：所有面盆、浴櫃牌價均不含水龍頭、落水頭及其它配件。

## 精選優質防水浴櫃

環保耐用防水防腐 | 經得起時間的考驗

### ■ 浴櫃材質

**KARAT** PVC 板



密度高於一般市售品質 (>0.55)

### ■ 外觀樣式

**PVC 貼皮**

PVC Veneer

- 不會腐爛
- 健康環保
- 壽命長久



白木紋(CH)



淺木紋(CB)



深木紋(CG)



灰色石紋(CQ)



黑金石紋(CF)

**烤漆**

Baking Paint

- 不會腐爛
- 健康環保
- 超耐黃變
- 多層烤漆
- 壽命長久



白色亮面(CA)



黑色霧面(B)

拍攝圖片僅供參考,產品每塊紋路皆有所不同,故商品若有紋路顏色差異,皆屬正常。  
logo需刻雕刻周圍會有些許焦痕,也屬正常現象。

## 洗手空間的選擇

防水防鏽 / 無懼水氣侵蝕 / 超高密度PVC板材 / 使用壽命更長久

### ■ 岩鋼石檯面+各式面盆

**岩鋼石材**

Slate

- 耐刮材質
- 超高硬度
- 優質手感
- 健康環保
- 壽命長久



勞倫白金



勞倫黑金



莎羅蘭



銀狐白



亞曼尼灰

### ■ 一體成型陶瓷盆



拍攝圖片僅供參考,產品每塊紋路皆有所不同,故商品若有紋路顏色差異,皆屬正常。

# LUXURY

輕奢，  
是生活的藝術







本浴櫃可訂做側櫃 (62cm除外)



側櫃:左邊-L



側櫃:右邊-R



雙門



雙門



雙門



雙門



三門

62cm

- 陶瓷盆 K-1360  
Ceramic basin  
Size: 615x465x170mm  
List Price: **\$12,400.**

- 防水發泡板浴櫃 KC-360CH  
Waterproof bathroom cabinet  
Size: 595x455x480mm  
List Price: **\$20,500.**

合計: **\$32,900.**

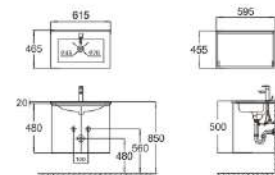

72cm

- 陶瓷盆 K-1367  
Ceramic basin  
Size: 715x465x170mm  
List Price: **\$14,000.**

- 防水發泡板浴櫃  
Waterproof bathroom cabinet  
Size: 695x455x480mm

- 無側櫃 KC-367CH **\$21,500.**
- 右側櫃 KC-367CH-R **\$26,500.**
- 左側櫃 KC-367CH-L **\$26,500.**

合計: **\$35,500.**(無側櫃) / **\$40,500.**(有側櫃)

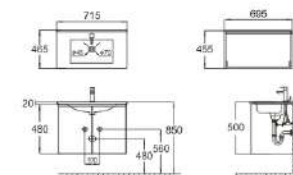

82cm

- 陶瓷盆 K-1361  
Ceramic basin  
Size: 815x465x170mm  
List Price: **\$15,600.**

- 防水發泡板浴櫃  
Waterproof bathroom cabinet  
Size: 795x455x480mm

- 無側櫃 KC-361CH **\$22,500.**
- 右側櫃 KC-361CH-R **\$27,500.**
- 左側櫃 KC-361CH-L **\$27,500.**

合計: **\$38,100.**(無側櫃) / **\$43,100.**(有側櫃)

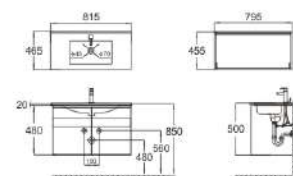

102cm

- 陶瓷盆 K-1362  
Ceramic basin  
Size: 1015x465x170mm  
List Price: **\$21,900.**

- 防水發泡板浴櫃  
Waterproof bathroom cabinet  
Size: 995x455x480mm

- 無側櫃 KC-362CH **\$26,800.**
- 右側櫃 KC-362CH-R **\$31,800.**
- 左側櫃 KC-362CH-L **\$31,800.**

合計: **\$48,700.**(無側櫃) / **\$53,700.**(有側櫃)

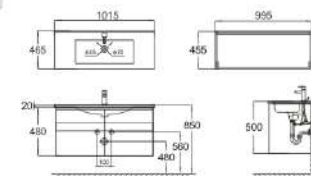

122cm

- 陶瓷盆 K-1363  
Ceramic basin  
Size: 1215x465x170mm  
List Price: **\$30,500.**

- 防水發泡板浴櫃  
Waterproof bathroom cabinet  
Size: 1195x455x480mm

- 無側櫃 KC-363CH **\$28,800.**
- 右側櫃 KC-363CH-R **\$33,800.**
- 左側櫃 KC-363CH-L **\$33,800.**

合計: **\$59,300.**(無側櫃) / **\$64,300.**(有側櫃)

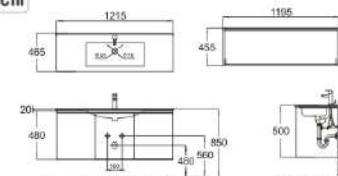

# CLASSIC

經典，  
歷久彌新的絕對姿態





本浴櫃可訂做側櫃 (62cm除外)



側櫃:左邊-L



側櫃:右邊-R



• 陶瓷盆 K-1360  
Ceramic basin  
Size: 615x465x170mm  
List Price: **\$12,400.**

62cm

• 防水發泡板浴櫃 KC-360CB  
Waterproof bathroom cabinet  
Size: 595x455x480mm  
List Price: **\$20,500.**

合計: **\$32,900.**

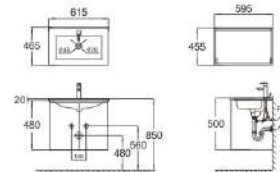

• 陶瓷盆 K-1367  
Ceramic basin  
Size: 715x465x170mm  
List Price: **\$14,000.**

72cm

• 防水發泡板浴櫃  
Waterproof bathroom cabinet  
Size: 695x455x480mm

無側櫃 KC-367CB \$21,500.  
右側櫃 KC-367CB-R \$26,500.  
左側櫃 KC-367CB-L \$26,500.

合計: **\$35,500.(無側櫃) / \$40,500.(有側櫃)**

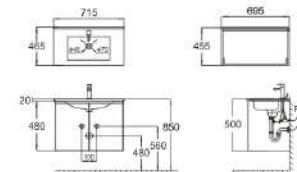

• 陶瓷盆 K-1361  
Ceramic basin  
Size: 815x465x170mm  
List Price: **\$15,600.**

82cm

• 防水發泡板浴櫃  
Waterproof bathroom cabinet  
Size: 795x455x480mm

無側櫃 KC-361CB \$22,500.  
右側櫃 KC-361CB-R \$27,500.  
左側櫃 KC-361CB-L \$27,500.

合計: **\$38,100.(無側櫃) / \$43,100.(有側櫃)**

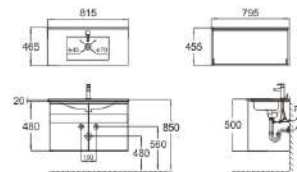

• 陶瓷盆 K-1362  
Ceramic basin  
Size: 1015x465x170mm  
List Price: **\$21,900.**

102cm

• 防水發泡板浴櫃  
Waterproof bathroom cabinet  
Size: 995x455x480mm

無側櫃 KC-362CB \$26,800.  
右側櫃 KC-362CB-R \$31,800.  
左側櫃 KC-362CB-L \$31,800.

合計: **\$48,700.(無側櫃) / \$53,700.(有側櫃)**

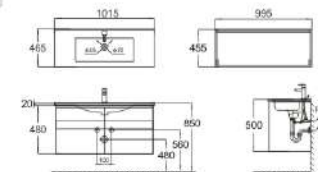

• 陶瓷盆 K-1363  
Ceramic basin  
Size: 1215x465x170mm  
List Price: **\$30,500.**

122cm

• 防水發泡板浴櫃  
Waterproof bathroom cabinet  
Size: 1195x455x480mm

無側櫃 KC-363CB \$28,800.  
右側櫃 KC-363CB-R \$33,800.  
左側櫃 KC-363CB-L \$33,800.

合計: **\$59,300.(無側櫃) / \$64,300.(有側櫃)**

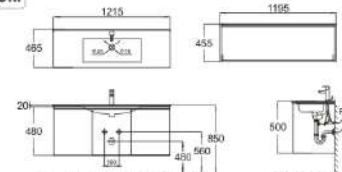

註: 浴櫃組不含龍頭及其他配件 浴櫃材質: PVC發泡板貼PVC皮

# TASTE

品味，  
不是鋪張，是態度





本浴櫃可訂做側櫃 (62cm除外)



側櫃:左邊-L



側櫃:右邊-R



雙門



雙門



雙門



雙門



三門

- 陶瓷盆 K-1360  
Ceramic basin  
Size: 615x465x170mm  
List Price: **\$12,400.**

62cm

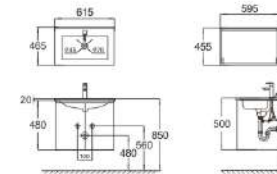

- 防水發泡板浴櫃 KC-360CG  
Waterproof bathroom cabinet  
Size: 595x455x480mm  
List Price: **\$20,500.**

合計: **\$32,900.**

- 陶瓷盆 K-1367  
Ceramic basin  
Size: 715x465x170mm  
List Price: **\$14,000.**

72cm

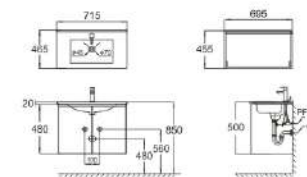

- 防水發泡板浴櫃  
Waterproof bathroom cabinet  
Size: 695x455x480mm

無側櫃 KC-367CG **\$21,500.**  
右側櫃 KC-367CG-R **\$26,500.**  
左側櫃 KC-367CG-L **\$26,500.**

合計: **\$35,500.**(無側櫃) / **\$40,500.**(有側櫃)

- 陶瓷盆 K-1361  
Ceramic basin  
Size: 815x465x170mm  
List Price: **\$15,600.**

82cm

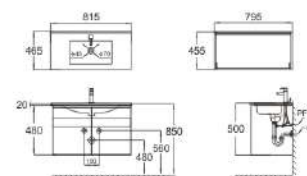

- 防水發泡板浴櫃  
Waterproof bathroom cabinet  
Size: 795x455x480mm

無側櫃 KC-361CG **\$22,500.**  
右側櫃 KC-361CG-R **\$27,500.**  
左側櫃 KC-361CG-L **\$27,500.**

合計: **\$38,100.**(無側櫃) / **\$43,100.**(有側櫃)

- 陶瓷盆 K-1362  
Ceramic basin  
Size: 1015x465x170mm  
List Price: **\$21,900.**

102cm

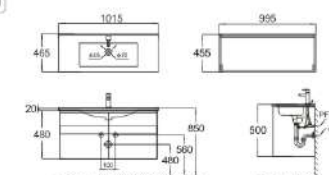

- 防水發泡板浴櫃  
Waterproof bathroom cabinet  
Size: 995x455x480mm

無側櫃 KC-362CG **\$26,800.**  
右側櫃 KC-362CG-R **\$31,800.**  
左側櫃 KC-362CG-L **\$31,800.**

合計: **\$48,700.**(無側櫃) / **\$53,700.**(有側櫃)

- 陶瓷盆 K-1363  
Ceramic basin  
Size: 1215x465x170mm  
List Price: **\$30,500.**

122cm

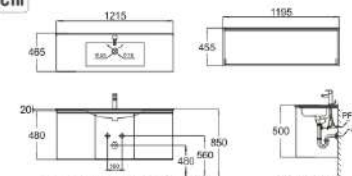

- 防水發泡板浴櫃  
Waterproof bathroom cabinet  
Size: 1195x455x480mm

無側櫃 KC-363CG **\$28,800.**  
右側櫃 KC-363CG-R **\$33,800.**  
左側櫃 KC-363CG-L **\$33,800.**

合計: **\$59,300.**(無側櫃) / **\$64,300.**(有側櫃)

HOME

家，  
堅持用幸福來投資



MILAN

111 112

· 米蘭清新系列 ·





本浴櫃可訂做側櫃 (62cm除外)



側櫃:左邊-L



側櫃:右邊-R



雙門

- 陶瓷盆 K-1360  
Ceramic basin  
Size: 615x465x170mm  
List Price: **\$12,400.**

62cm

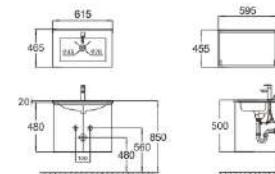

- 防水發泡板浴櫃 KC-360CA  
Waterproof bathroom cabinet  
Size: 595x455x480mm  
List Price: **\$22,800.**

合計: **\$35,200.**



雙門

- 陶瓷盆 K-1367  
Ceramic basin  
Size: 715x465x170mm  
List Price: **\$14,000.**

72cm

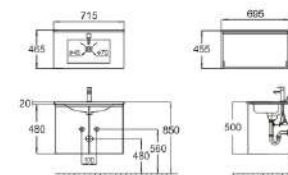

- 防水發泡板浴櫃  
Waterproof bathroom cabinet  
Size: 695x455x480mm

無側櫃 KC-367CA **\$23,900.**  
右側櫃 KC-367CA-R **\$28,900.**  
左側櫃 KC-367CA-L **\$28,900.**

合計: **\$37,900.**(無側櫃) / **\$42,900.**(有側櫃)



雙門

- 陶瓷盆 K-1361  
Ceramic basin  
Size: 815x465x170mm  
List Price: **\$15,600.**

82cm

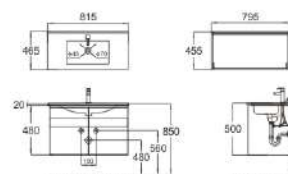

- 防水發泡板浴櫃  
Waterproof bathroom cabinet  
Size: 795x455x480mm

無側櫃 KC-361CA **\$25,000.**  
右側櫃 KC-361CA-R **\$30,000.**  
左側櫃 KC-361CA-L **\$30,000.**

合計: **\$40,600.**(無側櫃) / **\$45,600.**(有側櫃)



雙門

- 陶瓷盆 K-1362  
Ceramic basin  
Size: 1015x465x170mm  
List Price: **\$21,900.**

102cm

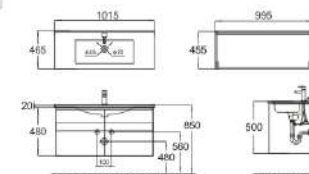

- 防水發泡板浴櫃  
Waterproof bathroom cabinet  
Size: 995x455x480mm

無側櫃 KC-362CA **\$29,800.**  
右側櫃 KC-362CA-R **\$34,800.**  
左側櫃 KC-362CA-L **\$34,800.**

合計: **\$51,700.**(無側櫃) / **\$56,700.**(有側櫃)



三門

- 陶瓷盆 K-1363  
Ceramic basin  
Size: 1215x465x170mm  
List Price: **\$30,500.**

122cm

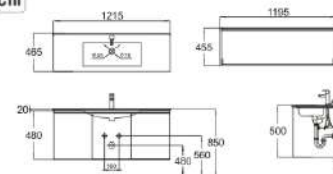

- 防水發泡板浴櫃  
Waterproof bathroom cabinet  
Size: 1195x455x480mm

無側櫃 KC-363CA **\$32,000.**  
右側櫃 KC-363CA-R **\$37,000.**  
左側櫃 KC-363CA-L **\$37,000.**

合計: **\$62,500.**(無側櫃) / **\$67,500.**(有側櫃)

註: 浴櫃組不含龍頭及其他配件 浴櫃材質: PVC發泡板烤漆

單位:mm



• 陶瓷盆 K-1360  
Ceramic basin  
Size: 615x465x170mm  
List Price: **\$12,400.**

62cm

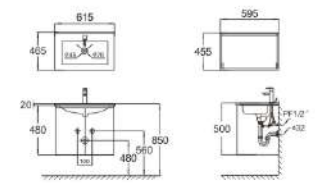

• 防水發泡板浴櫃 KC-360B  
Waterproof bathroom cabinet  
Size: 595x455x480mm  
List Price: **\$22,800.**

合計: **\$35,200.**



• 陶瓷盆 K-1367  
Ceramic basin  
Size: 715x465x170mm  
List Price: **\$14,000.**

72cm

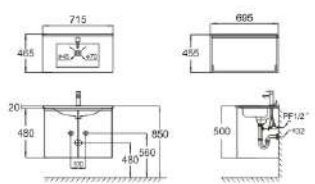

• 防水發泡板浴櫃 KC-367B  
Waterproof bathroom cabinet  
Size: 695x455x480mm  
List Price: **\$23,900.**

合計: **\$37,900.**



• 陶瓷盆 K-1361  
Ceramic basin  
Size: 815x465x170mm  
List Price: **\$15,600.**

82cm

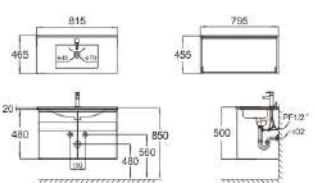

• 防水發泡板浴櫃 KC-361B  
Waterproof bathroom cabinet  
Size: 795x455x480mm  
List Price: **\$25,000.**

合計: **\$40,600.**



• 陶瓷盆 K-1362  
Ceramic basin  
Size: 1015x465x170mm  
List Price: **\$21,900.**

102cm

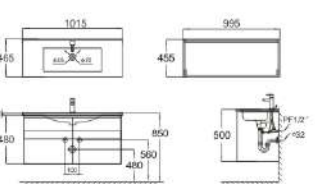

• 防水發泡板浴櫃 KC-362B  
Waterproof bathroom cabinet  
Size: 995x455x480mm  
List Price: **\$29,800.**

合計: **\$51,700.**



• 陶瓷盆 K-1363  
Ceramic basin  
Size: 1215x465x170mm  
List Price: **\$30,500.**

122cm

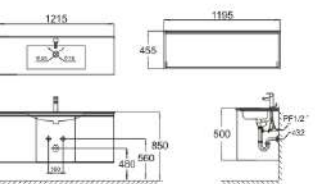

• 防水發泡板浴櫃 KC-363B  
Waterproof bathroom cabinet  
Size: 1195x455x480mm  
List Price: **\$32,000.**

合計: **\$62,500.**

註: 浴櫃組不含龍頭及其他配件 浴櫃材質: PVC發泡板烤漆



# SUPERB

美，  
終極生活進行式





• 陶瓷盆 K-1740  
Ceramic basin  
Size: 520x415x170mm  
List Price: **\$9,800.**

52cm

• 防水發泡板浴櫃 KC-740CH  
Waterproof bathroom cabinet  
Size: 480x375x450mm  
List Price: **\$15,700.**

合計: **\$25,500.**

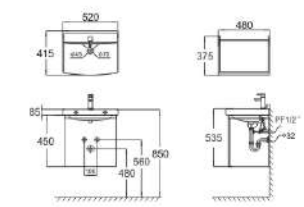

• 陶瓷盆 K-1741  
Ceramic basin  
Size: 620x415x170mm  
List Price: **\$ 11,800.**

62cm

• 防水發泡板浴櫃 KC-741CH  
Waterproof bathroom cabinet  
Size: 580x375x450mm  
List Price: **\$16,900.**

合計: **\$28,700.**

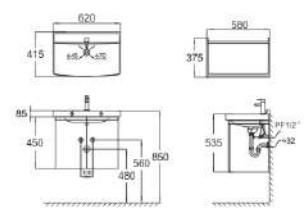

• 陶瓷盆 K-1747  
Ceramic basin  
Size: 720x415x170mm  
List Price: **\$12,800.**

72cm

• 防水發泡板浴櫃 KC-747CH  
Waterproof bathroom cabinet  
Size: 680x375x450mm  
List Price: **\$17,800.**

合計: **\$30,600.**

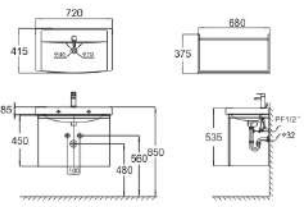

• 陶瓷盆 K-1742  
Ceramic basin  
Size: 820x415x170mm  
List Price: **\$ 13,800.**

82cm

• 防水發泡板浴櫃 KC-742CH  
Waterproof bathroom cabinet  
Size: 780x375x450mm  
List Price: **\$18,700.**

合計: **\$32,500.**

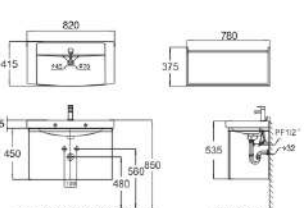

• 陶瓷盆 K-1743  
Ceramic basin  
Size: 920x415x170mm  
List Price: **\$ 15,800.**

92cm

• 防水發泡板浴櫃 KC-743CH  
Waterproof bathroom cabinet  
Size: 880x375x450mm  
List Price: **\$19,600.**

合計: **\$35,400.**

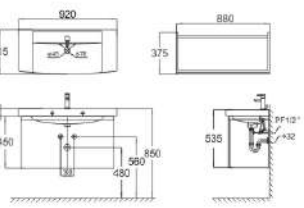

註: 浴櫃組不含龍頭及其他配件 浴櫃材質: PVC發泡板貼PVC皮

單位:mm

# DETAIL

細節，  
才能登峰造極



- 陶瓷盆 K-1740  
Ceramic basin  
Size: 520x415x170mm  
List Price: **\$9,800.**

52cm

- 防水發泡板浴櫃 KC-740CB  
Waterproof bathroom cabinet  
Size: 480x375x450mm  
List Price: **\$15,700.**

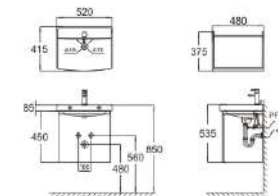
合計: **\$25,500.**

- 陶瓷盆 K-1741  
Ceramic basin  
Size: 620x415x170mm  
List Price: **\$11,800.**

62cm

- 防水發泡板浴櫃 KC-741CB  
Waterproof bathroom cabinet  
Size: 580x375x450mm  
List Price: **\$16,900.**

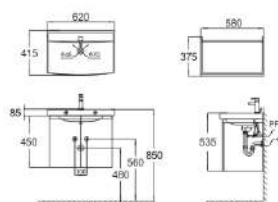
合計: **\$28,700.**

- 陶瓷盆 K-1747  
Ceramic basin  
Size: 720x415x170mm  
List Price: **\$12,800.**

72cm

- 防水發泡板浴櫃 KC-747CB  
Waterproof bathroom cabinet  
Size: 680x375x450mm  
List Price: **\$17,800.**

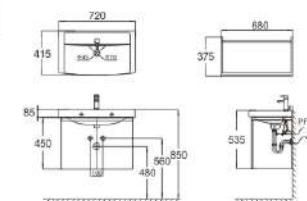
合計: **\$30,600.**

- 陶瓷盆 K-1742  
Ceramic basin  
Size: 820x415x170mm  
List Price: **\$13,800.**

82cm

- 防水發泡板浴櫃 KC-742CB  
Waterproof bathroom cabinet  
Size: 780x375x450mm  
List Price: **\$18,700.**

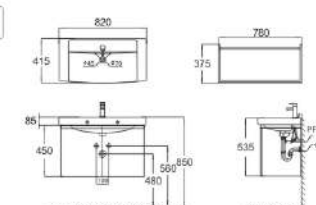
合計: **\$32,500.**

- 陶瓷盆 K-1743  
Ceramic basin  
Size: 920x415x170mm  
List Price: **\$15,800.**

92cm

- 防水發泡板浴櫃 KC-743CB  
Waterproof bathroom cabinet  
Size: 880x375x450mm  
List Price: **\$19,600.**

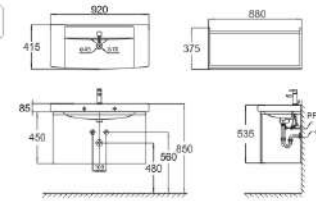
合計: **\$35,400.**

雙門



雙門



雙門



雙門



雙門

# ELEGANT

優雅，  
是從容的高度



·米萊森系列·



• 陶瓷盆 K-1740  
Ceramic basin  
Size: 520x415x170mm  
List Price: **\$9,800.**

52cm

• 防水發泡板浴櫃 KC-740CG  
Waterproof bathroom cabinet  
Size: 480x375x450mm  
List Price: **\$15,700.**

合計: **\$25,500.**

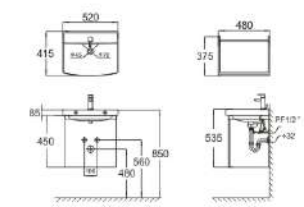

• 陶瓷盆 K-1741  
Ceramic basin  
Size: 620x415x170mm  
List Price: **\$ 11,800.**

62cm

• 防水發泡板浴櫃 KC-741CG  
Waterproof bathroom cabinet  
Size: 580x375x450mm  
List Price: **\$16,900.**

合計: **\$28,700.**

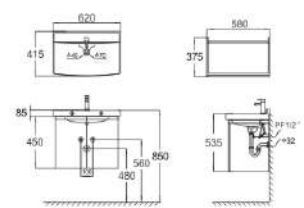

• 陶瓷盆 K-1747  
Ceramic basin  
Size: 720x415x170mm  
List Price: **\$12,800.**

72cm

• 防水發泡板浴櫃 KC-747CG  
Waterproof bathroom cabinet  
Size: 680x375x450mm  
List Price: **\$17,800.**

合計: **\$30,600.**

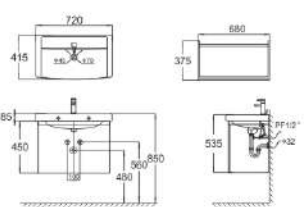

• 陶瓷盆 K-1742  
Ceramic basin  
Size: 820x415x170mm  
List Price: **\$ 13,800.**

82cm

• 防水發泡板浴櫃 KC-742CG  
Waterproof bathroom cabinet  
Size: 780x375x450mm  
List Price: **\$18,700.**

合計: **\$32,500.**

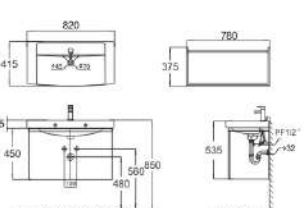

• 陶瓷盆 K-1743  
Ceramic basin  
Size: 920x415x170mm  
List Price: **\$ 15,800.**

92cm

• 防水發泡板浴櫃 KC-743CG  
Waterproof bathroom cabinet  
Size: 880x375x450mm  
List Price: **\$19,600.**

合計: **\$35,400.**

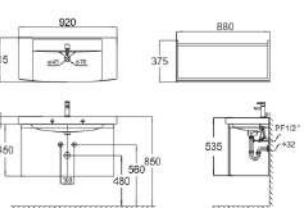

註: 浴櫃組不含龍頭及其他配件 浴櫃材質: PVC發泡板貼PVC皮

單位:mm



• 陶瓷盆 K-1740  
Ceramic basin  
Size: 520x415x170mm  
List Price: **\$9,800.**

52cm

• 防水發泡板浴櫃 KC-740H  
Waterproof bathroom cabinet  
Size: 480x375x450mm  
List Price: **\$17,400.**

合計: **\$27,200.**

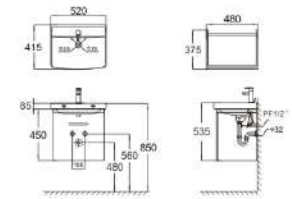

• 陶瓷盆 K-1741  
Ceramic basin  
Size: 620x415x170mm  
List Price: **\$11,800.**

62cm

• 防水發泡板浴櫃 KC-741H  
Waterproof bathroom cabinet  
Size: 580x375x450mm  
List Price: **\$18,400.**

合計: **\$30,200.**

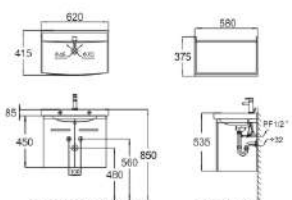

• 陶瓷盆 K-1747  
Ceramic basin  
Size: 720x415x170mm  
List Price: **\$12,800.**

72cm

• 防水發泡板浴櫃 KC-747H  
Waterproof bathroom cabinet  
Size: 680x375x450mm  
List Price: **\$19,400.**

合計: **\$32,200.**

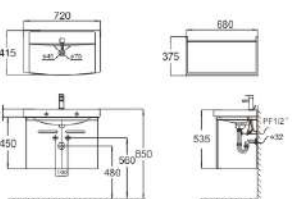

• 陶瓷盆 K-1742  
Ceramic basin  
Size: 820x415x170mm  
List Price: **\$13,800.**

82cm

• 防水發泡板浴櫃 KC-742H  
Waterproof bathroom cabinet  
Size: 780x375x450mm  
List Price: **\$20,400.**

合計: **\$34,200.**

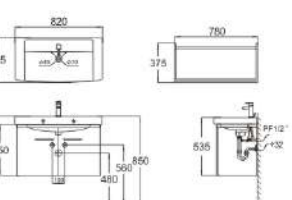

• 陶瓷盆 K-1743  
Ceramic basin  
Size: 920x415x170mm  
List Price: **\$15,800.**

92cm

• 防水發泡板浴櫃 KC-743H  
Waterproof bathroom cabinet  
Size: 880x375x450mm  
List Price: **\$21,400.**

合計: **\$37,200.**

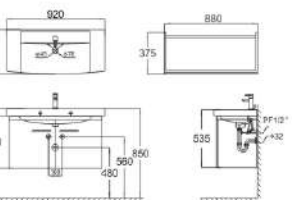

註: 浴櫃組不含龍頭及其他配件 浴櫃材質: PVC發泡板烤漆

單位:mm



- 陶瓷盆 K-1740  
Ceramic basin  
Size: 520x415x170mm  
List Price: **\$9,800.**

52cm

- 防水發泡板浴櫃 KC-740S  
Waterproof bathroom cabinet  
Size: 480x375x450mm  
List Price: **\$17,400.**

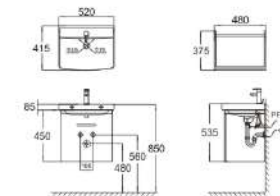
合計: **\$27,200.**

- 陶瓷盆 K-1741  
Ceramic basin  
Size: 620x420x170mm  
List Price: **\$11,800.**

62cm

- 防水發泡板浴櫃 KC-741S  
Waterproof bathroom cabinet  
Size: 580x375x450mm  
List Price: **\$18,400.**

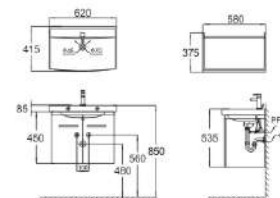
合計: **\$30,200.**

- 陶瓷盆 K-1747  
Ceramic basin  
Size: 720x410x170mm  
List Price: **\$12,800.**

72cm

- 防水發泡板浴櫃 KC-747S  
Waterproof bathroom cabinet  
Size: 680x375x450mm  
List Price: **\$19,400.**

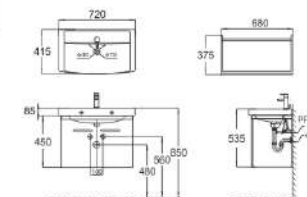
合計: **\$32,200.**

- 陶瓷盆 K-1742  
Ceramic basin  
Size: 820x410x170mm  
List Price: **\$13,800.**

82cm

- 防水發泡板浴櫃 KC-742S  
Waterproof bathroom cabinet  
Size: 780x375x450mm  
List Price: **\$20,400.**

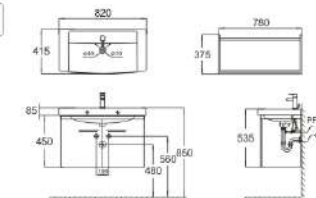
合計: **\$34,200.**

- 陶瓷盆 K-1743  
Ceramic basin  
Size: 920x415x170mm  
List Price: **\$15,800.**

92cm

- 防水發泡板浴櫃 KC-743S  
Waterproof bathroom cabinet  
Size: 880x375x450mm  
List Price: **\$21,400.**

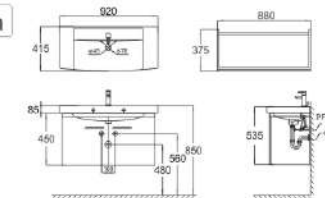
合計: **\$37,200.**

註: 浴櫃組不含龍頭及其他配件 浴櫃材質: PVC發泡板烤漆

單位:mm



# IMPLICATION

意蘊，  
讓想法微旅行



· 米萊清悟系列 ·



本浴櫃可訂做側櫃



側櫃:左邊-L



側櫃:右邊-R



單門



單門



單門



單門



雙門

• 陶瓷盆 K-1740  
Ceramic basin  
Size: 520x415x170mm  
List Price: **\$9,800.**

52cm

• 防水發泡板浴櫃  
Waterproof bathroom cabinet  
Size: 480x375x450mm

無側櫃 KC-740CHN \$15,700.  
右側櫃 KC-740CHN-R \$20,700.  
左側櫃 KC-740CHN-L \$20,700.

合計: **\$25,500.**(無側櫃) / **\$30,500.**(有側櫃)

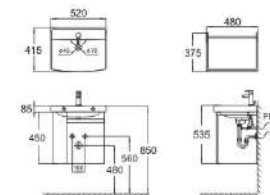

• 陶瓷盆 K-1741  
Ceramic basin  
Size: 620x415x170mm  
List Price: **\$11,800.**

62cm

• 防水發泡板浴櫃  
Waterproof bathroom cabinet  
Size: 580x375x450mm

無側櫃 KC-741CHN \$16,600.  
右側櫃 KC-741CHN-R \$21,600.  
左側櫃 KC-741CHN-L \$21,600.

合計: **\$28,400.**(無側櫃) / **\$33,400.**(有側櫃)

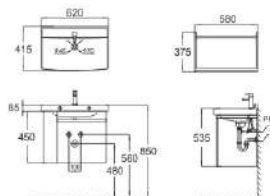

• 陶瓷盆 K-1747  
Ceramic basin  
Size: 720x415x170mm  
List Price: **\$12,800.**

72cm

• 防水發泡板浴櫃  
Waterproof bathroom cabinet  
Size: 680x375x450mm

無側櫃 KC-747CHN \$17,500.  
右側櫃 KC-747CHN-R \$22,500.  
左側櫃 KC-747CHN-L \$22,500.

合計: **\$30,300.**(無側櫃) / **\$35,300.**(有側櫃)

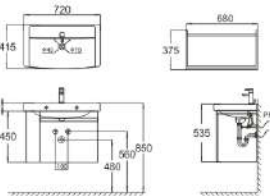

• 陶瓷盆 K-1742  
Ceramic basin  
Size: 820x415x170mm  
List Price: **\$13,800.**

82cm

• 防水發泡板浴櫃  
Waterproof bathroom cabinet  
Size: 780x375x450mm

無側櫃 KC-742CHN \$18,700.  
右側櫃 KC-742CHN-R \$23,700.  
左側櫃 KC-742CHN-L \$23,700.

合計: **\$32,500.**(無側櫃) / **\$37,500.**(有側櫃)

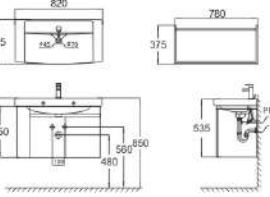

• 陶瓷盆 K-1743  
Ceramic basin  
Size: 920x415x170mm  
List Price: **\$15,800.**

92cm

• 防水發泡板浴櫃  
Waterproof bathroom cabinet  
Size: 880x375x450mm

無側櫃 KC-743CHN \$19,600.  
右側櫃 KC-743CHN-R \$24,600.  
左側櫃 KC-743CHN-L \$24,600.

合計: **\$35,400.**(無側櫃) / **\$40,400.**(有側櫃)

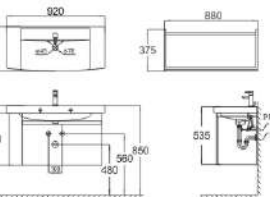

註: 浴櫃組不含龍頭及其他配件 浴櫃材質: PVC發泡板貼PVC皮

單位:mm

# BRISK

雅致，  
美的昇華





本浴櫃可訂做側櫃



側櫃:左邊-L



側櫃:右邊-R



• 陶瓷盆 K-1740  
Ceramic basin  
Size: 520x415x170mm  
List Price: **\$9,800.**

52cm

• 防水發泡板浴櫃  
Waterproof bathroom cabinet  
Size: 480x375x450mm

無側櫃 KC-740CBN \$15,700.  
右側櫃 KC-740CBN-R \$20,700.  
左側櫃 KC-740CBN-L \$20,700.

合計: **\$25,500.**(無側櫃) / **\$30,500.**(有側櫃)

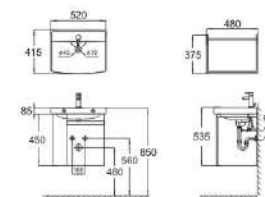

• 陶瓷盆 K-1741  
Ceramic basin  
Size: 620x415x170mm  
List Price: **\$11,800.**

62cm

• 防水發泡板浴櫃  
Waterproof bathroom cabinet  
Size: 580x375x450mm

無側櫃 KC-741CBN \$16,600.  
右側櫃 KC-741CBN-R \$21,600.  
左側櫃 KC-741CBN-L \$21,600.

合計: **\$28,400.**(無側櫃) / **\$33,400.**(有側櫃)

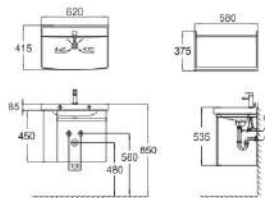

• 陶瓷盆 K-1747  
Ceramic basin  
Size: 720x415x170mm  
List Price: **\$12,800.**

72cm

• 防水發泡板浴櫃  
Waterproof bathroom cabinet  
Size: 680x375x450mm

無側櫃 KC-747CBN \$17,500.  
右側櫃 KC-747CBN-R \$22,500.  
左側櫃 KC-747CBN-L \$22,500.

合計: **\$30,300.**(無側櫃) / **\$35,300.**(有側櫃)

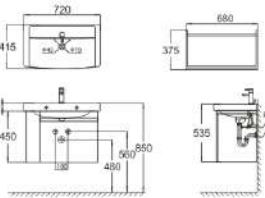

• 陶瓷盆 K-1742  
Ceramic basin  
Size: 820x415x170mm  
List Price: **\$13,800.**

82cm

• 防水發泡板浴櫃  
Waterproof bathroom cabinet  
Size: 780x375x450mm

無側櫃 KC-742CBN \$18,700.  
右側櫃 KC-742CBN-R \$23,700.  
左側櫃 KC-742CBN-L \$23,700.

合計: **\$32,500.**(無側櫃) / **\$37,500.**(有側櫃)

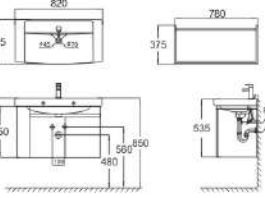

• 陶瓷盆 K-1743  
Ceramic basin  
Size: 920x415x170mm  
List Price: **\$15,800.**

92cm

• 防水發泡板浴櫃  
Waterproof bathroom cabinet  
Size: 880x375x450mm

無側櫃 KC-743CBN \$19,600.  
右側櫃 KC-743CBN-R \$24,600.  
左側櫃 KC-743CBN-L \$24,600.

合計: **\$35,400.**(無側櫃) / **\$40,400.**(有側櫃)

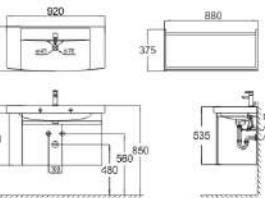

註: 浴櫃組不含龍頭及其他配件 浴櫃材質: PVC發泡板貼PVC皮

單位:mm

# VOGUE

時尚，  
絕不將就





本浴櫃可訂做側櫃



側櫃:左邊-L



側櫃:右邊-R



- 陶瓷盆 K-1740  
Ceramic basin  
Size: 520x415x170mm  
List Price: **\$9,800.**

52cm

- 防水發泡板浴櫃  
Waterproof bathroom cabinet  
Size: 480x375x450mm

- 無側櫃 KC-740CGN \$15,700.
- 右側櫃 KC-740CGN-R \$20,700.
- 左側櫃 KC-740CGN-L \$20,700.

合計: \$25,500.(無側櫃) / \$30,500.(有側櫃)

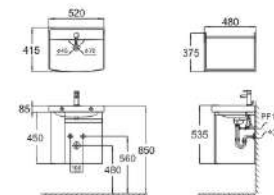

- 陶瓷盆 K-1741  
Ceramic basin  
Size: 620x415x170mm  
List Price: **\$11,800.**

62cm

- 防水發泡板浴櫃  
Waterproof bathroom cabinet  
Size: 580x375x450mm

- 無側櫃 KC-741CGN \$16,600.
- 右側櫃 KC-741CGN-R \$21,600.
- 左側櫃 KC-741CGN-L \$21,600.

合計: \$28,400.(無側櫃) / \$33,400.(有側櫃)

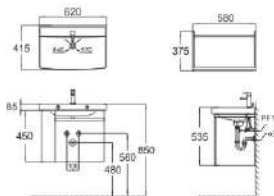

- 陶瓷盆 K-1747  
Ceramic basin  
Size: 720x415x170mm  
List Price: **\$12,800.**

72cm

- 防水發泡板浴櫃  
Waterproof bathroom cabinet  
Size: 680x375x450mm

- 無側櫃 KC-747CGN \$17,500.
- 右側櫃 KC-747CGN-R \$22,500.
- 左側櫃 KC-747CGN-L \$22,500.

合計: \$30,300.(無側櫃) / \$35,300.(有側櫃)

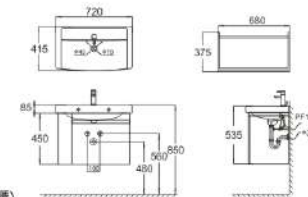

- 陶瓷盆 K-1742  
Ceramic basin  
Size: 820x415x170mm  
List Price: **\$13,800.**

82cm

- 防水發泡板浴櫃  
Waterproof bathroom cabinet  
Size: 780x375x450mm

- 無側櫃 KC-742CGN \$18,700.
- 右側櫃 KC-742CGN-R \$23,700.
- 左側櫃 KC-742CGN-L \$23,700.

合計: \$32,500.(無側櫃) / \$37,500.(有側櫃)

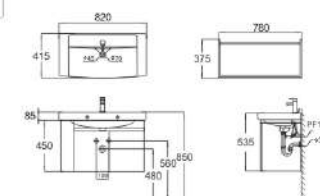

- 陶瓷盆 K-1743  
Ceramic basin  
Size: 920x415x170mm  
List Price: **\$15,800.**

92cm

- 防水發泡板浴櫃  
Waterproof bathroom cabinet  
Size: 880x375x450mm

- 無側櫃 KC-743CGN \$19,600.
- 右側櫃 KC-743CGN-R \$24,600.
- 左側櫃 KC-743CGN-L \$24,600.

合計: \$35,400.(無側櫃) / \$40,400.(有側櫃)

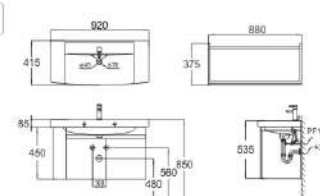

註: 浴櫃組不含龍頭及其他配件 浴櫃材質: PVC發泡板貼PVC皮

單位:mm

# SIMPLICITY

簡約，不減風雅





本浴櫃可訂做側櫃



側櫃:左邊-L



側櫃:右邊-R



- 陶瓷盆 K-1740  
Ceramic basin  
Size: 520x415x170mm  
List Price: **\$9,800.**

52cm

- 防水發泡板浴櫃  
Waterproof bathroom cabinet  
Size: 480x375x450mm

- 無側櫃 KC-740CQN \$15,700.
- 右側櫃 KC-740CQN-R \$20,700.
- 左側櫃 KC-740CQN-L \$20,700.

合計: \$25,500.(無側櫃) / \$30,500.(有側櫃)

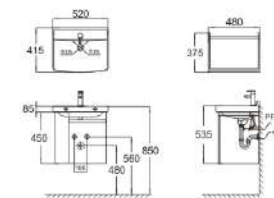

- 陶瓷盆 K-1741  
Ceramic basin  
Size: 620x415x170mm  
List Price: **\$11,800.**

62cm

- 防水發泡板浴櫃  
Waterproof bathroom cabinet  
Size: 580x375x450mm

- 無側櫃 KC-741CQN \$16,600.
- 右側櫃 KC-741CQN-R \$21,600.
- 左側櫃 KC-741CQN-L \$21,600.

合計: \$28,400.(無側櫃) / \$33,400.(有側櫃)

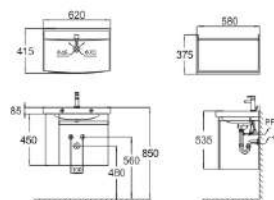

- 陶瓷盆 K-1747  
Ceramic basin  
Size: 720x415x170mm  
List Price: **\$12,800.**

72cm

- 防水發泡板浴櫃  
Waterproof bathroom cabinet  
Size: 680x375x450mm

- 無側櫃 KC-747CQN \$17,500.
- 右側櫃 KC-747CQN-R \$22,500.
- 左側櫃 KC-747CQN-L \$22,500.

合計: \$30,300.(無側櫃) / \$35,300.(有側櫃)

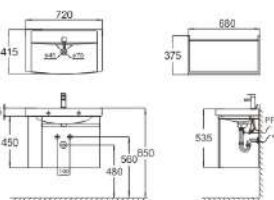

- 陶瓷盆 K-1742  
Ceramic basin  
Size: 820x415x170mm  
List Price: **\$13,800.**

82cm

- 防水發泡板浴櫃  
Waterproof bathroom cabinet  
Size: 780x375x450mm

- 無側櫃 KC-742CQN \$18,700.
- 右側櫃 KC-742CQN-R \$23,700.
- 左側櫃 KC-742CQN-L \$23,700.

合計: \$32,500.(無側櫃) / \$37,500.(有側櫃)

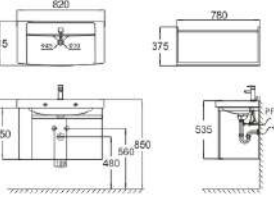

- 陶瓷盆 K-1743  
Ceramic basin  
Size: 920x415x170mm  
List Price: **\$15,800.**

92cm

- 防水發泡板浴櫃  
Waterproof bathroom cabinet  
Size: 880x375x450mm

- 無側櫃 KC-743CQN \$19,600.
- 右側櫃 KC-743CQN-R \$24,600.
- 左側櫃 KC-743CQN-L \$24,600.

合計: \$35,400.(無側櫃) / \$40,400.(有側櫃)

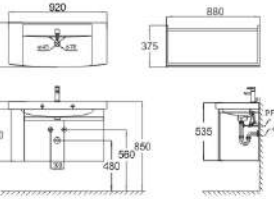

註: 浴櫃組不含龍頭及其他配件 浴櫃材質: PVC發泡板貼PVC皮

單位:mm



# EXQUISITE

精緻，雍容的空間





本浴櫃可訂做側櫃



側櫃:左邊-L



側櫃:右邊-R



• 陶瓷盆 K-1740  
Ceramic basin  
Size: 520x415x170mm  
List Price: **\$9,800.**

52cm

• 防水發泡板浴櫃  
Waterproof bathroom cabinet  
Size: 480x375x450mm

無側櫃 KC-740CFN **\$15,700.**  
右側櫃 KC-740CFN-R **\$20,700.**  
左側櫃 KC-740CFN-L **\$20,700.**

合計: **\$25,500.**(無側櫃) / **\$30,500.**(有側櫃)

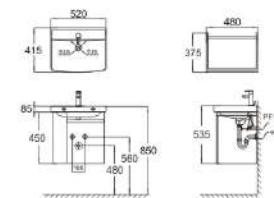

• 陶瓷盆 K-1741  
Ceramic basin  
Size: 620x415x170mm  
List Price: **\$11,800.**

62cm

• 防水發泡板浴櫃  
Waterproof bathroom cabinet  
Size: 580x375x450mm

無側櫃 KC-741CFN **\$16,600.**  
右側櫃 KC-741CFN-R **\$21,600.**  
左側櫃 KC-741CFN-L **\$21,600.**

合計: **\$28,400.**(無側櫃) / **\$33,400.**(有側櫃)

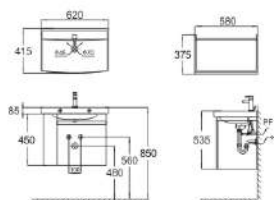

• 陶瓷盆 K-1747  
Ceramic basin  
Size: 720x415x170mm  
List Price: **\$12,800.**

72cm

• 防水發泡板浴櫃  
Waterproof bathroom cabinet  
Size: 680x375x450mm

無側櫃 KC-747CFN **\$17,500.**  
右側櫃 KC-747CFN-R **\$22,500.**  
左側櫃 KC-747CFN-L **\$22,500.**

合計: **\$30,300.**(無側櫃) / **\$35,300.**(有側櫃)

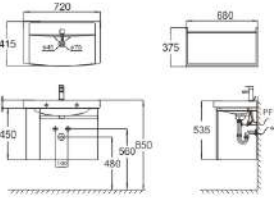

• 陶瓷盆 K-1742  
Ceramic basin  
Size: 820x415x170mm  
List Price: **\$13,800.**

82cm

• 防水發泡板浴櫃  
Waterproof bathroom cabinet  
Size: 780x375x450mm

無側櫃 KC-742CFN **\$18,700.**  
右側櫃 KC-742CFN-R **\$23,700.**  
左側櫃 KC-742CFN-L **\$23,700.**

合計: **\$32,500.**(無側櫃) / **\$37,500.**(有側櫃)

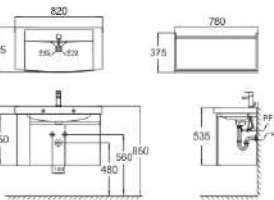

• 陶瓷盆 K-1743  
Ceramic basin  
Size: 920x415x170mm  
List Price: **\$15,800.**

92cm

• 防水發泡板浴櫃  
Waterproof bathroom cabinet  
Size: 880x375x450mm

無側櫃 KC-743CFN **\$19,600.**  
右側櫃 KC-743CFN-R **\$24,600.**  
左側櫃 KC-743CFN-L **\$24,600.**

合計: **\$35,400.**(無側櫃) / **\$40,400.**(有側櫃)

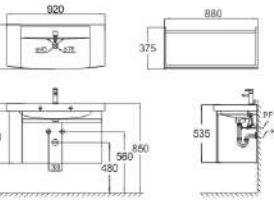

註: 浴櫃組不含龍頭及其他配件 浴櫃材質: PVC發泡板貼PVC皮



GEM · 微珣系列 ·



註：面盆於安裝時，可隨意轉放，選擇龍頭於左側或右側



• 陶瓷盆 K-1916  
Ceramic basin  
Size: 445x230x74mm  
List Price: **\$6,200.**

• 防水發泡板浴櫃 KC-916CH  
Waterproof bathroom cabinet  
Size: 435x223x450mm  
List Price: **\$9,200.**

合計: **\$15,400.**

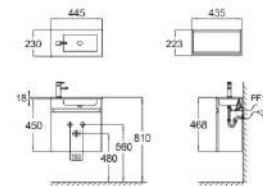

• 陶瓷盆 K-1916  
Ceramic basin  
Size: 445x230x74mm  
List Price: **\$6,200.**

• 防水發泡板浴櫃 KC-916CB  
Waterproof bathroom cabinet  
Size: 435x223x450mm  
List Price: **\$9,200.**

合計: **\$15,400.**

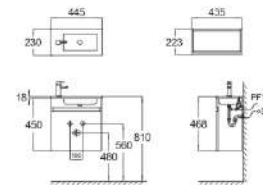

• 陶瓷盆 K-1916  
Ceramic basin  
Size: 445x230x74mm  
List Price: **\$6,200.**

• 防水發泡板浴櫃 KC-916CG  
Waterproof bathroom cabinet  
Size: 435x223x450mm  
List Price: **\$9,200.**

合計: **\$15,400.**

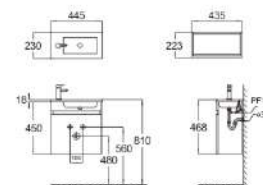

• 陶瓷盆 K-1916  
Ceramic basin  
Size: 445x230x74mm  
List Price: **\$6,200.**

• 防水發泡板浴櫃 KC-916CQ  
Waterproof bathroom cabinet  
Size: 435x223x450mm  
List Price: **\$9,200.**

合計: **\$15,400.**

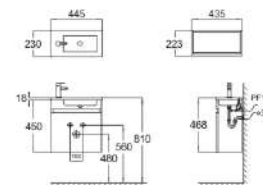

• 陶瓷盆 K-1916  
Ceramic basin  
Size: 445x230x74mm  
List Price: **\$6,200.**

• 防水發泡板浴櫃 KC-916CF  
Waterproof bathroom cabinet  
Size: 435x223x450mm  
List Price: **\$9,200.**

合計: **\$15,400.**

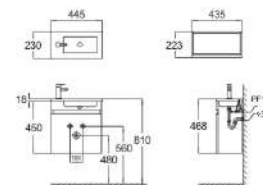

註：浴櫃組不含龍頭及其他配件 浴櫃材質：PVC發泡板貼PVC皮

單位:mm



KC-922T  
雙門



單門

MANTZ 曼姿  
• 陶瓷盆 K-1922R  
Ceramic basin  
Size: 430x290x145mm  
List Price: **\$ 4,600.**

• 防水發泡板浴櫃 KC-922  
Waterproof bathroom cabinet  
Size: 360x250x480mm  
List Price: **\$ 9,200.**

合計: **\$ 13,800.**

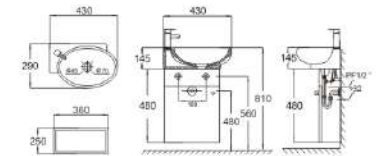

MANTZ 曼姿  
K-1922R

• 藝術盆  
Artistic basin  
Size: 430x290x145mm  
Above counter mounting  
List Price: **\$ 4,600.**

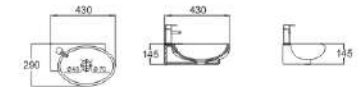

單門

MANTZ 曼姿  
• 陶瓷盆 K-1922L  
Ceramic basin  
Size: 430x290x145mm  
List Price: **\$ 4,600.**

• 防水發泡板浴櫃 KC-922  
Waterproof bathroom cabinet  
Size: 360x250x480mm  
List Price: **\$ 9,200.**

合計: **\$ 13,800.**

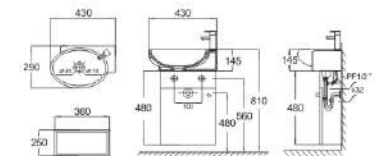

陶瓷盆 K-1922T  
排水管 G-024

MANTZ 曼姿  
• 陶瓷盆 K-1922T  
Ceramic basin  
Size: 500x270x120mm  
List Price: **\$ 6,500.**

• 防水發泡板浴櫃 KC-922T  
Waterproof bathroom cabinet  
Size: 490x170x480mm  
List Price: **\$ 13,000.**

合計: **\$ 19,500.**

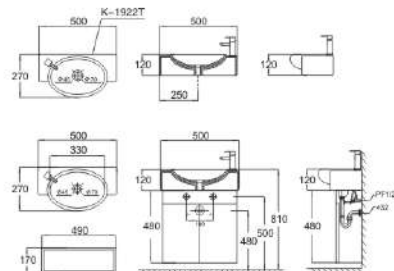

MANTZ 曼姿  
K-1922L

• 藝術盆  
Artistic basin  
Size: 430x290x145mm  
Above counter mounting  
List Price: **\$ 4,600.**

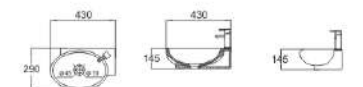

·洗衣盆櫃系列·



- 陶瓷盆 K-1236  
Ceramic basin  
Size: 600x505x250mm  
List Price: **\$ 12,000.**
- 防水發泡板浴櫃 KC-236H  
PVC waterproof bathroom cabinet  
Size: 515x345x600mm  
List Price: **\$ 19,200.**

合計: **\$ 31,200.**

60cm

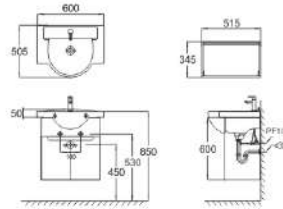

- 陶瓷盆 K-1237  
Ceramic basin  
Size: 800x505x250mm  
List Price: **\$ 12,800.**
- 防水發泡板浴櫃 KC-237H  
PVC waterproof bathroom cabinet  
Size: 700x345x600mm  
List Price: **\$ 21,200.**

合計: **\$ 34,000.**

80cm

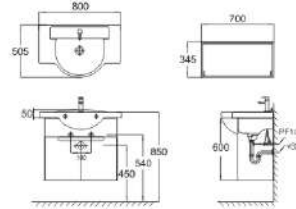

- 陶瓷盆 K-1934F  
Ceramic basin  
Size: 525x415x165mm  
List Price: **\$ 8,000.**
- 防水發泡板藝術浴櫃 KC-934  
Waterproof bathroom cabinet  
Size: 495x400x600mm  
List Price: **\$ 13,800.**

合計: **\$ 21,800.**

52cm

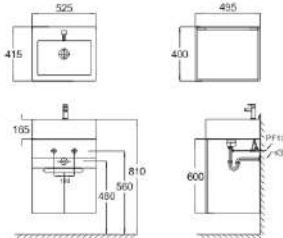

- 防水實木框鏡(附平台) NF-4924  
Waterproof mirror cabinet  
Size: 700x120x850mm  
List Price: **\$ 9,000.**
- 洗髮盆專用水龍頭 FP-7800  
List Price: **\$ 12,000.**
- 陶瓷盆 K-1424  
Ceramic basin  
Size: 800x560x290mm  
List Price: **\$ 16,800.**
- 防水實木髮盆浴櫃 KC-424  
Waterproof bathroom cabinet  
Size: 800x445x800mm  
List Price: **\$ 32,000.**

合計: **\$ 69,800.**

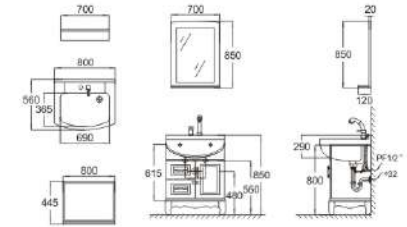

- 洗衣櫃(瓷器) K-1882  
Wash sink basket  
Size: 630x480x330mm  
List Price: 盆 **\$ 18,800.**+落水頭 **\$ 2,000.**
- 防水實木浴櫃 KC-862W  
Waterproof bathroom cabinet  
Size: 595x470x760mm  
List Price: **\$ 29,800.**

合計: **\$ 50,600.**

含落水頭不含籃子及洗衣板

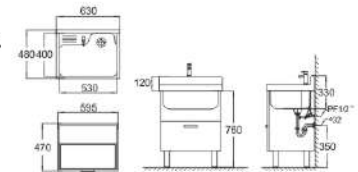

**K-1803+K-1583+GM-004**

- 拖布盆  
Mop tub  
Size: 550x470x650mm  
Fixing to wall with back  
List Price: 盆 **\$ 16,800.**柱 **\$ 4,800.**  
落水頭 **\$ 2,000.**

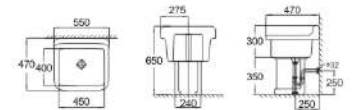

純手工創製而成

期



- K-182W  
洗衣板 / Washboard  
Size: 220x500x18mm  
List Price: **\$ 1,200.**

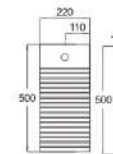

- SK-2609  
洗衣槽籃 / Wash sink basket  
List Price: **\$ 1,200.**
- GM-003  
落水頭  
List Price: **\$ 2,000.**





Mira系列櫃盆  
隱形擴充浴室的秘密.....

## Ceramic basin

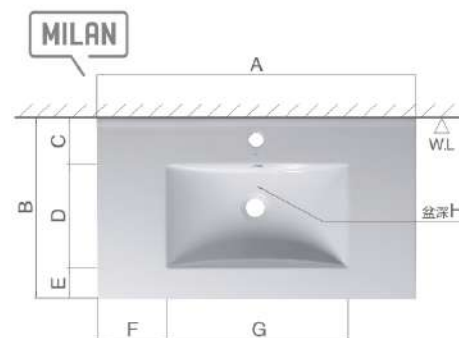

單位:mm	A	B	C	D	E	F	G	H	水容量
K-1360	615	465	125	270	70	93	429	120	4.90L
K-1367	715	465	125	270	70	135	445	120	4.95L
K-1361	815	465	125	270	70	180	455	120	5.00L
K-1362	1015	465	125	270	70	260	495	125	5.35L
K-1363	1215	465	125	270	70	350	515	135	5.55L

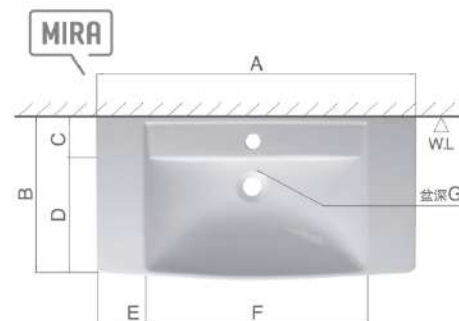

單位:mm	A	B	C	D	E	F	G	水容量
K-1740 沒有前側平台	520	415	105	310	15	490	110	4.80L
K-1741 沒有前側平台	620	415	105	310	15	590	110	5.00L
K-1747	720	415	105	310	70	580	110	4.90L
K-1742	820	415	105	310	120	580	110	4.90L
K-1743	920	415	105	310	150	620	110	5.12L

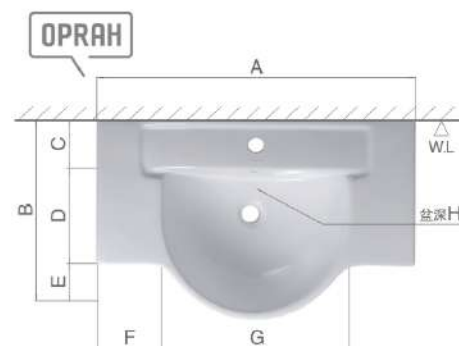

單位:mm	A	B	C	D	E	F	G	H	水容量
K-1236	600	505	125	245	135	75	450	170	9.95L
K-1237	805	505	125	245	135	160	485	170	10.05L

龍頭系列尺寸圖：

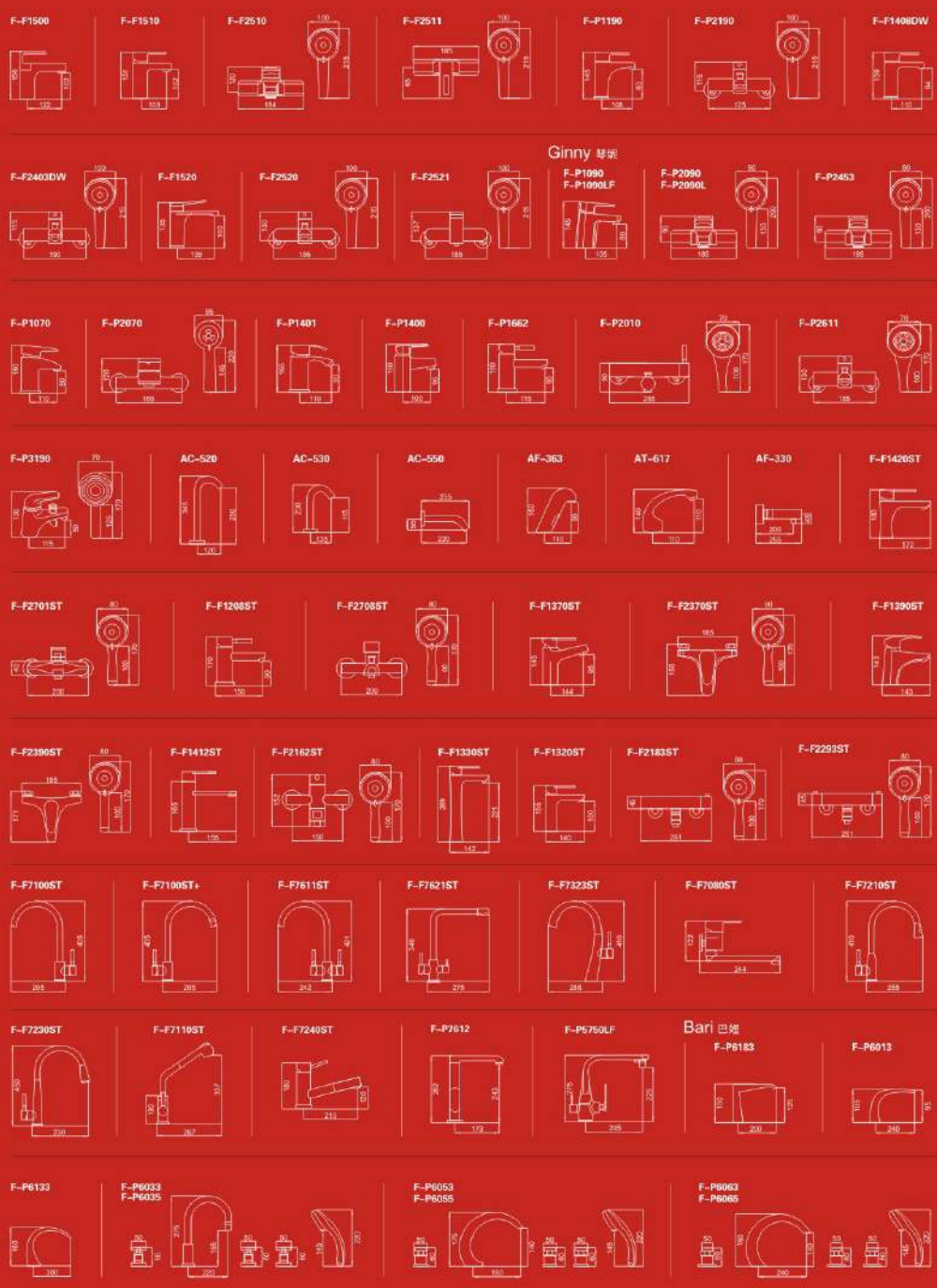

# Integrity

誠信是立業之本，  
 所有行為，以客戶利益為先；  
 所有承諾，以認真負責履行為要。

# 水世界 · 心無界

體貼家庭主婦的設計



※凱樂衛浴水龍頭均採用銅製

獨家落水頭附濾網，毛髮好清洗，水管不阻塞  
凱樂衛浴水龍頭皆經過96小時的鹽霧測試





**F-P1190**  
 · 面盆龍頭  
 List Price: **\$ 6,800.**



**F-P2190**  
 · 沐浴龍頭  
 List Price: **\$ 8,900.**



**訂**  
**F-F1408DW**  
 · 面盆龍頭  
 List Price: **\$ 13,500.**



**訂**  
**F-F2403DW**  
 · 沐浴龍頭  
 List Price: **\$ 8,900.**



## Ballee 貝樂

- 代表 “附G-018美規按壓落水頭”
- 代表 “附G-015塑膠拉桿落水頭”



**F-F1500**  
 · 面盆龍頭  
 List Price: **\$ 9,800.**



**F-F1510**  
 · 面盆龍頭  
 List Price: **\$ 8,800.**



**F-F2510**  
 · 沐浴龍頭  
 List Price: **\$ 11,000.**



**F-F2511**  
 · 沐浴龍頭  
 List Price: **\$ 10,000.**



**F-F1520**  
 · 沐浴龍頭  
 List Price: **\$ 9,900.**



**F-F2520**  
 · 沐浴龍頭  
 List Price: **\$ 13,800.**



**F-F2521**  
 · 沐浴龍頭  
 List Price: **\$ 12,800.**

· 龍頭系列 ·



**F-P1070**  
· 面盆龍頭  
List Price: \$ 9,900.



**F-P2070**  
· 沐浴龍頭  
List Price: \$ 13,800.



**F-P1401** LF  
· 面盆龍頭  
List Price: \$ 12,800.



**F-P1400**  
· 面盆龍頭  
List Price: \$ 8,700.



## Ginny 琴妮

LF



**F-P1090**  
· 面盆龍頭  
List Price: \$ 8,400.  
**F-P1090LF**  
· 無鉛面盆龍頭  
List Price: \$ 10,000.



**F-P2090**  
· 沐浴龍頭  
List Price: \$ 11,700.



**F-P2090L**  
· 沐浴LED沐浴龍頭  
List Price: \$ 13,800.



**F-P2453**  
· 沐浴LED沐浴龍頭  
List Price: \$ 11,000.



**F-P1662**  
· 面盆龍頭  
List Price: \$ 7,500.



**F-P2010**  
· 沐浴龍頭  
List Price: \$ 9,000.



**F-P2611**  
· 沐浴龍頭  
List Price: \$ 8,700.



**F-P1630**  
 · 加高龍頭 (藝術碗盆專用)  
 List Price: **\$ 9,800.**



**F-P1713**  
 · 面盆龍頭  
 List Price: **\$ 8,500.**



**F-P1693**  
 · 面盆龍頭  
 List Price: **\$ 9,600.**



**AC-520**  
 · 加高感應式面盆龍頭  
 電源: 110V / 電池式  
 List Price: **\$ 16,000.**



**AC-530**  
 · 感應式面盆龍頭  
 電源: 110V / 電池式  
 List Price: **\$ 14,000.**



**AC-550**  
 · 壁式感應龍頭  
 電源: 110V / 電池式  
 List Price: **\$ 15,000.**



**F-P3190**  
 · 面盆沐浴兩用龍頭  
 List Price: **\$ 9,600.**



**F-P2713**  
 · 沐浴龍頭  
 List Price: **\$ 10,500.**



**F-P2693**  
 · 沐浴龍頭  
 List Price: **\$ 13,500.**



**AF-363**  
 · 感應式面盆龍頭  
 電源: 110V~220V  
 List Price: **\$ 17,000.**



**AT-617**  
 · 感應式面盆龍頭  
 電源: 110V  
 List Price: **\$ 15,200.**



**期 AF-330**  
 · 壁式感應龍頭  
 電源: 電池式  
 List Price: **\$ 15,600.**



# 超大出水量

大大滿足平日洗滌用水需求



4分出水口徑

含氟高分子濾芯

高吸附椰殼活性炭

### 過濾規格

- 1.阻隔細菌效率:99%以上
- 2.可阻隔之重金屬:鉛、鉍、鎘、鐵、鈣、銅、錳、鎘、鎳、鈉等等
- 3.工作溫度4-70°C

一般市售過濾為2分出水口,每分鐘最大僅3公升



**F-P7596 (短管)**  
• 淨水廚房龍頭  
List Price: **\$ 21,500.**



**F-P7597 (短管)**  
• 淨水廚房龍頭  
List Price: **\$ 19,500.**



**F-P7598 (扁長管)**  
• 淨水廚房龍頭  
List Price: **\$ 19,500.**



**F-P7599 (扁管短)**  
• 淨水廚房龍頭  
List Price: **\$ 18,800.**



**F-P7591 (高管)**  
• 淨水廚房龍頭  
List Price: **\$ 20,800.**



**F-P7592 (高管)**  
• 淨水廚房龍頭  
List Price: **\$ 22,500.**



**F-P7593 (高管)**  
• 淨水廚房龍頭  
List Price: **\$ 22,500.**



**F-P7595 (高管)**  
• 淨水廚房龍頭  
List Price: **\$ 20,000.**

• 龍頭系列 •



**F-P7192**  
• 淨水面盆龍頭  
List Price: **\$ 22,000.**



**F-P7193**  
• 淨水面盆龍頭  
List Price: **\$ 22,000.**



**F-P7195**  
• 淨水面盆龍頭  
List Price: **\$ 19,500.**

**F-P2291**  
• 淨水沐浴龍頭  
List Price: **\$ 22,500.**



**F-P2292**  
• 淨水沐浴龍頭  
List Price: **\$ 22,500.**



**F-P2293**  
• 淨水沐浴龍頭  
List Price: **\$ 22,500.**



**F-P2580**  
• 淨水廚房龍頭(壁式)  
List Price: **\$ 22,000.**



**F-P2581**  
• 淨水廚房龍頭(壁式)  
List Price: **\$ 22,000.**



LF

**F-F1420ST**

• 不鏽鋼面盆龍頭

List Price: **\$ 7,600.**

LF

**F-F2701ST**

• 不鏽鋼沐浴龍頭

List Price: **\$ 11,000.**

LF

**F-F1208ST**

• 不鏽鋼面盆龍頭

List Price: **\$ 6,980.**

LF

**F-F2708ST**

• 不鏽鋼沐浴龍頭

List Price: **\$ 7,800.**

LF

**F-F1370ST**

• 不鏽鋼面盆龍頭

List Price: **\$ 7,200.**

LF

**F-F1390ST**

• 不鏽鋼沐浴龍頭

List Price: **\$ 7,500.****F-F1412ST**

• 不鏽鋼面盆龍頭

List Price: **\$ 9,800.**

LF

**F-F2370ST**

• 不鏽鋼沐浴龍頭

List Price: **\$ 8,900.**

LF

**F-F2390ST**

• 不鏽鋼沐浴龍頭

List Price: **\$ 9,600.****F-F2162ST**

• 不鏽鋼沐浴龍頭

List Price: **\$ 12,800.**



## Jenny 珍妮



**F-F1330ST**  
• 不鏽鋼面盆龍頭  
List Price: \$ 7,800.



**F-F1320ST**  
• 不鏽鋼面盆龍頭  
List Price: \$ 7,500.



**F-F5183ST**  
• 不鏽鋼淋浴柱  
List Price: \$ 22,000.



**F-F5193ST**  
• 不鏽鋼淋浴柱(溫控)  
List Price: \$ 29,800.



**F-F2183ST**  
• 不鏽鋼沐浴龍頭  
List Price: \$ 15,800.



**F-F2293ST**  
• 不鏽鋼沐浴龍頭(溫控)  
List Price: \$ 23,600.





**F-F7210ST**  
 • 不銹鋼廚房龍頭(抽拉) LF  
 List Price: **\$13,200.**



**F-F7110ST**  
 • 不銹鋼廚房龍頭(抽拉) LF  
 List Price: **\$12,000.**



**F-P7612**  
 • 廚房龍頭(三用無鉛銅)  
 List Price: **\$15,800.**



**F-F7230ST**  
 • 不銹鋼廚房龍頭(抽拉) LF  
 List Price: **\$13,800.**



**F-F7240ST**  
 • 不銹鋼廚房龍頭(抽拉) LF  
 List Price: **\$12,800.**



**F-P5750LF**  
 • 無鉛廚房龍頭(無鉛銅) LF  
 List Price: **\$21,700.**



**F-F7100ST**  
 • 不銹鋼廚房龍頭(立式) LF  
 List Price: **\$6,900.**



**F-F7611ST**  
 • 不銹鋼廚房龍頭(立式) LF  
 List Price: **\$15,800.**



**F-F7323ST**  
 • 不銹鋼廚房龍頭(立式) LF  
 List Price: **\$14,800.**



**F-F7100ST+**  
 • 不銹鋼廚房龍頭(廣向) LF  
 List Price: **\$7,900.**



**F-F7621ST**  
 • 不銹鋼廚房龍頭(三用) LF  
 List Price: **\$14,700.**



**F-F7080ST**  
 • 不銹鋼廚房龍頭(壁式) LF  
 List Price: **\$7,900.**





**F-P6183**  
• 浴缸龍頭  
List Price: **\$ 18,500.**



**F-P6013**  
• 浴缸龍頭  
List Price: **\$ 28,500.**



**F-P6133**  
• 長頸三件式浴缸龍頭 (30公分)  
List Price: **\$ 15,000.**



**F-P9630**  
浴缸龍頭  
• List Price: **\$ 23,000.**  
附FJ-119C蓮蓬頭



**F-P6063**  
• 三件式浴缸龍頭  
List Price: **\$ 13,200.**



**F-P6053**  
• 三件式浴缸龍頭  
List Price: **\$ 12,000.**



**F-P6033**  
• 三件式浴缸龍頭  
List Price: **\$ 10,800.**

**F-P6035**  
• 五件式浴缸龍頭  
List Price: **\$ 16,800.**

**F-P6055**  
• 五件式浴缸龍頭  
List Price: **\$ 18,000.**

**F-P6065**  
• 五件式浴缸龍頭  
List Price: **\$ 19,200.**



**SB-107**  
• 不銹鋼滑桿 (拉絲)  
List Price: **\$ 3,800.**



**SB-107A (SC-107A)**  
• 不銹鋼滑桿 (亮光)  
List Price: **\$ 4,200.**



**FS-110**  
• 銅鍍鉻滑桿  
List Price: **\$ 1,900.**



**F-P6150ST**  
• 不銹鋼浴缸龍頭 (拉絲紋)  
List Price: **\$ 25,000.**



· 淋浴龍頭系列



**F-F2151B**  
 · 沐浴龍頭組 (有下出水)  
 List Price: **\$ 18,800.**



**F-F5151B**  
 · 淋浴龍頭組 (有下出水)  
 List Price: **\$ 24,800.**



**F-F5151**  
 · 淋浴龍頭組 (無下出水)  
 List Price: **\$ 22,800.**



**F-P5363**  
 · 淋浴龍頭組  
 List Price: **\$ 21,600.**



**F-P5360**  
 · 淋浴龍頭組  
 List Price: **\$ 21,600.**



**F-P5370**  
 · 淋浴龍頭組 (無下出水)  
 List Price: **\$ 21,000.**



**F-P2110**  
 · 控溫沐浴龍頭  
 List Price: **\$ 19,200.**



**F-P5110**  
 · 淋浴龍頭組 (有下出水)  
 List Price: **\$ 28,000.**



**F-P5390B**  
 · 淋浴龍頭組 (有下出水)  
 List Price: **\$ 23,000.**



**F-F5390X**  
 · 淋浴龍頭組 (無下出水)  
 List Price: **\$ 21,000.**



· 花灑頭系列 ·



**側向進水花灑頭**

**F-J330 ABS**  
· 花灑頭 20cm  
List Price: \$ 1,800.

**功能說明**  
側向進水(傳統都是由上方進水),不但美觀新穎,可解決一般浴室天花板過低問題。

**F-J117C**  
· 蓮蓬頭把手  
List Price: \$ 700.



**F-J227 ABS**  
· 花灑頭 22cm  
List Price: \$ 2,100.



**F-J228 ABS**  
· 花灑頭 20cm  
List Price: \$ 1,500.

· 蓮蓬頭把手系列 ·

 <b>F-J110C</b> · 蓮蓬頭把手 List Price: \$ 500.	 <b>F-JB110C</b> · 蓮蓬頭把手 List Price: \$ 500.	 <b>F-J114C</b> · 蓮蓬頭把手 List Price: \$ 700.	 <b>F-JB113</b> · 蓮蓬頭把手 List Price: \$ 1,500.	 <b>F-J120C</b> · 蓮蓬頭把手 (二段式) List Price: \$ 700.
 <b>F-J131C</b> · 蓮蓬頭把手 (三段式) List Price: \$ 900.	 <b>F-JB132</b> · 蓮蓬頭把手 (三段式) List Price: \$ 1,200.	 <b>F-J133C</b> · 蓮蓬頭把手 (三段式) List Price: \$ 800.	 <b>F-J132C</b> · 蓮蓬頭把手 (三段式) List Price: \$ 1,400.	 <b>F-JB135</b> · 蓮蓬頭把手 (三段式) List Price: \$ 1,400.
 <b>F-J131C-1</b> · 蓮蓬頭把手 (五段式) List Price: \$ 900.	 <b>F-JB151</b> · 蓮蓬頭把手 (五段式) List Price: \$ 1,600.	 <b>F-J150C</b> · 蓮蓬頭把手 (五段式) List Price: \$ 1,000.	 <b>F-JB115</b> · 過速蓮蓬頭把手 List Price: \$ 1,000.	 <b>F-JB500</b> · 蓮蓬頭滤芯 (4入) List Price: \$ 1,200.



**FA-1505**  
· 自閉龍頭 (含止水零件省水型)  
List Price: \$ 5,800.



**FA-1506**  
· 自閉龍頭 (省水型)  
List Price: \$ 3,000.



**KW-118B**  
· 水栓  
List Price: \$ 900.



**KW-2214**  
· 水栓  
List Price: \$ 1,000.

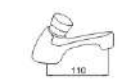

**KW-2114**  
· 水栓 (省水型)  
List Price: \$ 1,200.

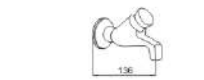

**KW-2043**  
· 水栓  
List Price: \$ 1,700.



**KW-3114**  
· 水栓 (省水型)  
List Price: \$ 1,100.



**KW-2042**  
· 水栓  
List Price: \$ 1,700.



**K-005ST**  
· 不銹鋼凡爾  
List Price: \$ 500.



**K-005LST**  
· 不銹鋼加長型凡爾  
List Price: \$ 600.



**K-005FST**  
· 不銹鋼凡爾龍頭  
List Price: \$ 600.



**K-005LFST**  
· 不銹鋼加長型凡爾龍頭  
List Price: \$ 600.



**K-005PST**  
· 不銹鋼皮質凡爾龍頭  
List Price: \$ 600.

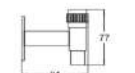

**K-005FPST**  
· 不銹鋼皮質凡爾雙用龍頭  
List Price: \$ 1,100.

# Quality Assurance

以時尚的設計、一流的品質，  
與消費者分享高貴優質產品，  
不斷提高消費大眾生活品質。

### Bathtubs 浴缸



#### KARAT 凱樂

鑄鐵浴缸非常注重結構的安全性，一般款式浴缸缸體厚度約為7-9 mm，搪瓷厚度0.8-1 mm，古典浴缸（俗稱貴妃缸）缸體厚度為12-15 mm，搪瓷厚度1-1.2 mm。重量約為85kg-140KG（以長度1500mm-1800mm換算）。表面搪瓷採用最高等級釉。



#### KARAT 凱樂

鑄鐵浴缸符合美國國家標準協會（ANSI）破壞測試。（也就是將鑄鐵浴缸放在沙地上，以一顆重100克鋼珠，以電流將鋼珠旋吸在浴缸上方100公分高，然後切斷電流使鋼珠以自由落體方式掉落在缸體表面，受撞擊面沒有任何損壞。）



#### KARAT 凱樂

鑄鐵浴缸表面硬度高不易刮傷藏污納垢，光潔平整，色澤溫潤，易清洗，使用年限長，保溫效果特別好。



#### KARAT 凱樂

鑄鐵浴缸排水組件皆使用銅材質，經久耐用不破裂漏水（比傳統的塑料材質使用壽命十倍），並開發落水頭附濾網，毛髮、戒指、異物等皆可攔截不會直接排至排水管內，好清洗又不阻塞。



銅製落水頭附濾網

# KARAT

古典鑄鐵搪瓷浴缸

Royal and  
noble and  
elegant

盡顯高貴典雅的皇家氣質！



KATAT鑄鐵浴缸安全環保, 易清, 使用壽命長, 保溫效果好。

型號 品名 尺寸 牌價 (各單品牌價)  
Model Name Size Price 搬運費另計

BT1779 鑄鐵浴缸 1709x790x470mm \$ 135,000(缸體 \$ 115,800, 落水頭 \$ 7,200, 虎腳 \$ 12,000.)

本款浴缸可以明式安裝及嵌入式安裝:  
明式安裝: 以四支虎腳支撐, 可任意擺放, 只須注意預留進水及排水位置即可。

安裝: 嵌入式安裝, 四周邊緣支撐, 支撐物可為木料、金屬或磚, 此款浴缸適合外置安裝。  
Installation: Embedded Installation, The bath is supported by its rims, which held by the timber, metal, or bricks. Suitable for the isolated installation.

耐用性: 採用堅固的原料不會變形、滲水, 進口釉表面可避免刮傷及污垢。  
Durability: Strong durable material which won't flex, bend, and letting water get through. Scratch and flitch and flith is prevented by the glazing surface.

浴缸排水孔: 浴缸的下水孔為直徑50標準孔  
Waste Outlet: Waste outlet is suitable for 50mm diameter standard waste assembly.

注意: 所有產品尺寸為mm, 本公司將持續設計改進並保留對其修改權利, 恕不另行通知。  
Note: All the unit is mm, we company will keep to develop the designing and reserve the right to modify without any other notice.

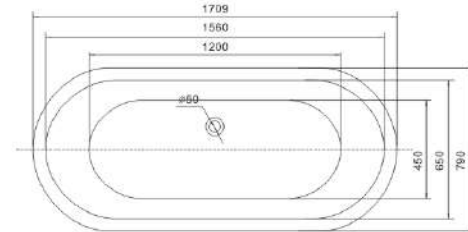

<p><b>標準配備</b></p> <p>品名: 浴缸落水頭附連喉 型號: E-TD1570 牌價: \$7,200.</p>	<p>水距440mm 內距205mm</p> <p>品名: 浴缸大進修孔 型號: VF-4L 牌價: \$2,100.</p>
<p>品名: 浴缸虎腳 會配紅專華 I 型號: E-TF1570 牌價: \$12,000. (一組4支)</p>	<p>水距178mm 內距155mm</p> <p>品名: 浴缸小進修孔 型號: VF-4S 牌價: \$420.</p>

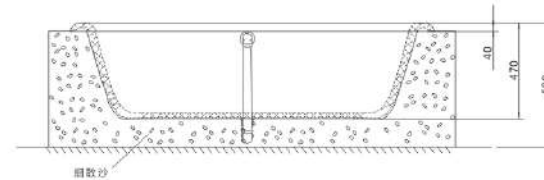

嵌入式安裝法

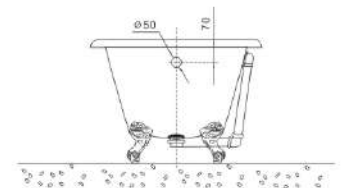
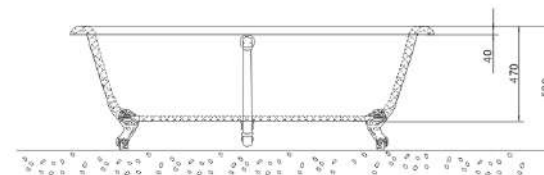

浴缸牌價皆不含龍頭及其他配件, 所有浴缸搬運費另計

Bathtub series

KATAI鑄鐵浴缸安全環保，易清，使用壽命長，保溫效果好。

型號 Model	品名 Name	尺寸 Size	牌價 Price	(各單品牌價) 搬運費另計
-------------	------------	------------	-------------	------------------

BT1478	鑄鐵浴缸	1460x780x590mm	\$ 99,000.	(缸體 \$ 79,800. 落水喉 \$ 7,200. 虎腳 \$ 12,000.)
BT1578	鑄鐵浴缸	1560x780x590mm	\$ 101,000.	(缸體 \$ 81,800. 落水喉 \$ 7,200. 虎腳 \$ 12,000.)

**安裝:** 明式安裝: 以四支虎腳支撐, 可任意擺放, 只須注意預留進水及排水位置即可, 此款浴缸適合外置安裝。  
**Installation:** non-embedded installation.

**耐用性:** 採用堅固的原料不會變形、滲水, 進口釉表面可避免刮傷及污垢。  
**Durability:** Strong durable material which won't flex, bend, and letting water get through. Scratch and flitch and firm is prevented by the glazing surface.

**浴缸排水孔:** 浴缸的下水孔為直徑50標準孔  
**Waste Outlet:** Waste outlet is suitable for 50mm diameter standard waste assembly.

**注意:** 所有產品尺寸為mm, 本公司將持續設計改進並保留對其修改權利, 恕不另行通知。  
**Note:** All the unit is mm, we company will keep to develop the designing and reserve the right to modify without any other notice.



Bathtub  
series

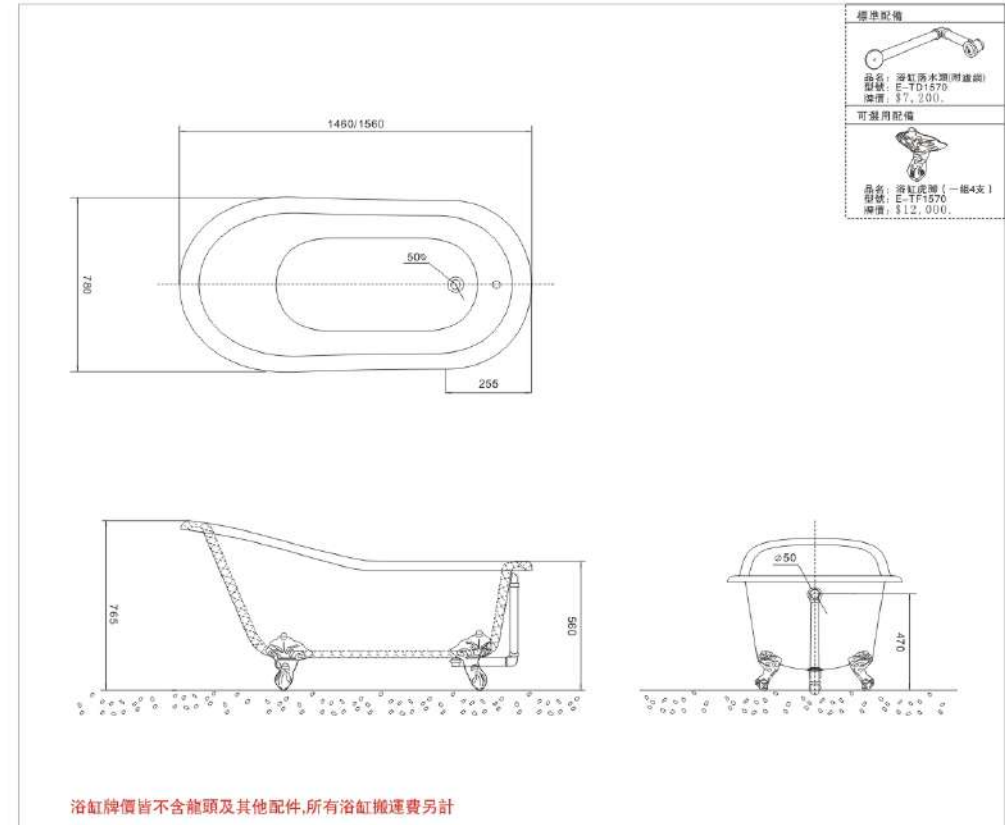

浴缸牌價皆不含龍頭及其他配件, 所有浴缸搬運費另計

# Bathtub series



型號 Model	品名 Name	尺寸 Size	牌價 Price	(各單品牌價) 搬運費另計
BT8475	鑄鐵浴缸	1400x750x420mm	\$38,400.	(缸體 \$28,800. 落水頭 \$4,400. 扶手 \$5,200.)
BT8575	鑄鐵浴缸	1500x750x420mm	\$40,000.	(缸體 \$30,400. 落水頭 \$4,400. 扶手 \$5,200.)
BT8675	鑄鐵浴缸	1600x750x420mm	\$43,000.	(缸體 \$33,400. 落水頭 \$4,400. 扶手 \$5,200.)
BT8775	鑄鐵浴缸	1700x750x420mm	\$46,200.	(缸體 \$36,600. 落水頭 \$4,400. 扶手 \$5,200.)
BT8780	鑄鐵浴缸	1700x800x420mm	\$61,000.	(缸體 \$51,400. 落水頭 \$4,400. 扶手 \$5,200.)
F-P6063	浴缸龍頭		\$13,200.	

**安裝:** 嵌入式安裝, 四周邊緣支撐, 支撐物可為木料、金屬或磚, 此款浴缸適合嵌入式安裝。  
**Installation:** Embedded Installation, The bath is supported by its rims, which held by the timber, metal, or bricks. Suitable for the isolated installation.

**耐用性:** 採用堅固的原料不會變形、滲水, 進口釉表面可避免刮傷及污垢。  
**Durability:** Strong durable material which won't flex, bend, and letting water get through. Scratch and flitch and flith is prevented by the glazing surface.

**浴缸排水孔:** 浴缸的下水孔為直徑50標準孔  
**Waste Outlet:** Waste outlet is suitable for 50mm diameter standard waste assembly.

**注意:** 所有產品尺寸為mm, 本公司將持續設計改進並保留對其修改權利, 恕不另行通知。  
**Note:** All the unit is mm, we company will keep to develop the designing and reserve the right to modify without any other notice.

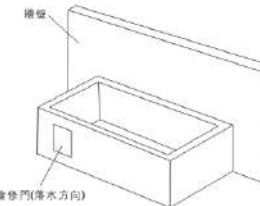
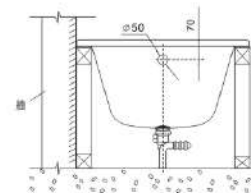
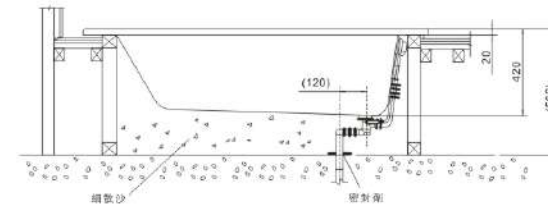
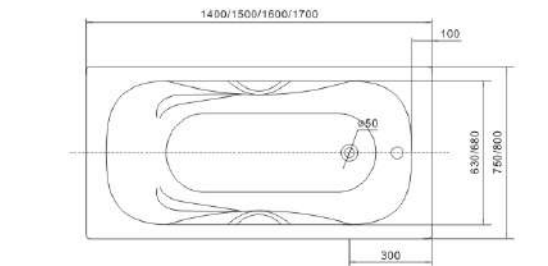

- 標準配備**
- 品名: 浴缸落水頭(附邊網)  
型號: E-TD4678  
牌價: \$4,400.
- 可選用配備**
- 品名: 浴缸大維修孔  
型號: VF-4L  
牌價: \$2,100.
  - 品名: 浴缸小維修孔  
型號: VF-4S  
牌價: \$420.
  - 品名: 鑄鐵浴缸龍頭  
型號: E-TF4676  
牌價: \$1,600.

浴缸牌價皆不含龍頭及其他配件, 所有浴缸搬運費另計

KATAT鑄鐵浴缸安全環保, 易清, 使用壽命強, 保溫效果好。

型號	品名	尺寸	牌價	(各單品牌價)
Model	Name	Size	Price	搬運費另計
BT7070	鑄鐵浴缸	1000x700x390mm	\$25,200.	(缸體 \$20,800. 落水頭 \$4,400.)
BT7270	鑄鐵浴缸	1200x700x390mm	\$26,400.	(缸體 \$22,000. 落水頭 \$4,400.)
BT7370	鑄鐵浴缸	1300x700x390mm	\$27,800.	(缸體 \$23,400. 落水頭 \$4,400.)
BT7470	鑄鐵浴缸	1400x700x420mm	\$29,000.	(缸體 \$24,600. 落水頭 \$4,400.)
BT7570	鑄鐵浴缸	1500x700x420mm	\$32,000.	(缸體 \$27,600. 落水頭 \$4,400.)
BT7670	鑄鐵浴缸	1600x700x420mm	\$35,500.	(缸體 \$31,100. 落水頭 \$4,400.)
BT7770	鑄鐵浴缸	1700x700x420mm	\$38,000.	(缸體 \$33,600. 落水頭 \$4,400.)

安裝: 嵌入式安裝, 四周邊緣支撐, 支撐物可為木料、金屬或磚, 此款浴缸適合嵌入式安裝。

Installation: Embedded installation. The bath is supported by its rims which held by the timber, metal, or bricks. Suitable for the isolated installation.

耐用性: 採用堅固的原料不會變形、滲水, 進口釉表面可避免刮傷及污垢。

Durability: Strong durable material which won't flex, bend, and letting water get through. Scratch and filth and filth is prevented by the glazing surface.

浴缸排水孔: 浴缸的下水孔為直徑50標準孔

Waste Outlet: Waste outlet is suitable for 50mm diameter standard waste assembly.

注意: 所有產品尺寸為mm, 本公司將持續設計改進並保留對其修改權利, 恕不另行通知。

Note: All the unit is mm, we company will keep to develop the designing and reserve the right to modify without any other notice.

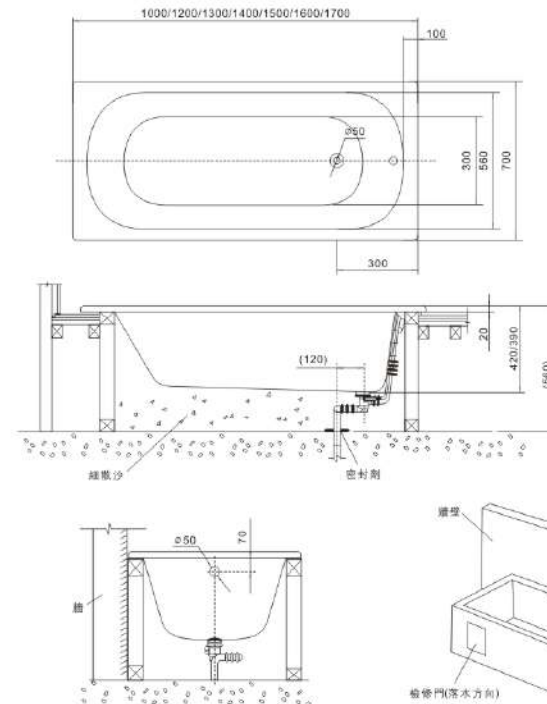

標準配備



品名: 浴缸落水頭(標準)  
型號: E-TD4678  
牌價: \$4,400.

可選用配備

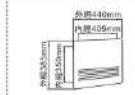

品名: 浴缸大蓋修孔  
型號: VF-4L  
牌價: \$2,100.



品名: 浴缸小蓋修孔  
型號: VF-4S  
牌價: \$420.



品名: 鑄鐵浴缸腳牌  
型號: E-TF4676  
牌價: \$1,600.

浴缸牌價皆不含龍頭及其他配件, 所有浴缸搬運費另計



Bathtub series



KATAT鑄鐵浴缸安全環保, 易清, 使用壽命強, 保溫效果好。

型號 Model	品名 Name	尺寸 Size	牌價 Price	(各單品牌價) 搬運費另計
BT6575	鑄鐵浴缸	1500x750x420mm	\$ 40,000.	(缸體 \$ 30,400. 落水頭 \$ 4,400. 扶手 \$ 5,200.)
BT6775	鑄鐵浴缸	1700x750x420mm	\$ 46,200.	(缸體 \$ 36,600. 落水頭 \$ 4,400. 扶手 \$ 5,200.)
BT6880	鑄鐵浴缸	1800x800x420mm	\$ 72,000.	(缸體 \$ 62,400. 落水頭 \$ 4,400. 扶手 \$ 5,200.)

**安裝:** 嵌入式安裝, 四周邊緣支撐, 支撐物可為木料、金屬或磚, 此款浴缸適合嵌入式安裝  
**Installation:** Embedded Installation, The bath is supported by its rims, which held by the timber, metal, or bricks. Suitable for the isolated installation.

**耐用性:** 採用堅固的原料不會變形、滲水, 進口釉表面可避免刮傷及污垢。  
**Durability:** Strong durable material which won't flex, bend, and letting water get through. Scratch and flitch and filth is prevented by the glazing surface.

**浴缸排水孔:** 浴缸的下水孔為直徑50標準孔  
**Waste Outlet:** Waste outlet is suitable for 50mm diameter standard waste assembly.

**注意:** 所有產品尺寸為mm, 本公司將持續設計改進並保留對其修改權利, 恕不另行通知。  
**Note:** All the unit is mm, we company will keep to develop the designing and reserve the right to modify without any other notice.



Bathtub  
series

**標準配備**

- 品名: 浴缸落水頭(側邊調)  
型號: E-TD4678  
牌價: \$4,400.
- 品名: 浴缸扶手 (2支/個)  
型號: E-TS6578  
牌價: \$5,200.

**可選用配備**

- 品名: 浴缸大維修孔  
型號: VF-4L  
牌價: \$2,100.
- 品名: 浴缸小維修孔  
型號: VF-4S  
牌價: \$420.
- 品名: 鑄鐵浴缸用溢層  
型號: E-TF4678  
牌價: \$1,600.

**浴缸牌價皆不含龍頭及其他配件, 所有浴缸搬運費另計**

## PRESS STEEL BATHTUB

· 鋼板法瑯浴缸系列 ·



### 鋼板法瑯浴缸(搪瓷浴缸)

- V-20A** Size: 1200x700x360mm List Price: **\$ 12,800.**
- V-30A** Size: 1300x700x360mm List Price: **\$ 12,800.**
- V-40A** Size: 1400x700x360mm List Price: **\$ 12,800.**
- V-50A** Size: 1500x700x360mm List Price: **\$ 12,800.**
- V-60A** Size: 1600x700x360mm List Price: **\$ 15,800.**
- V-70A** Size: 1700x700x360mm List Price: **\$ 17,800.**

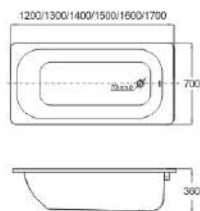

凱樂 **KARAT** 搪瓷浴缸研究開發出了A級釉面，採用低溫搪瓷的技術，燒製溫度在800℃左右，生產出外觀平整光滑高品質搪瓷浴缸。

凱樂 **KARAT** 鋼板搪瓷浴缸厚度為1.5mm，搪瓷釉面層厚度均控制在0.3mm以下，表面硬度高不易刮傷，不會因刮傷而易藏污納垢，是一個非常符合衛生要求的產品。

搪瓷浴缸止滑顆粒



以上浴缸牌價皆不含龍頭及其他配件,所有浴缸搬運費另計

## ACRYLIC FABRIC BATHTUBS

· 壓克力浴缸系列 ·

199 200



訂



### 壓克力空缸浴缸

- AH-1001**
- Size: 1650x720x570mm
- List Price: **\$ 128,000.**
- Capacity: 40 litres to rim, with overflow 50 litres

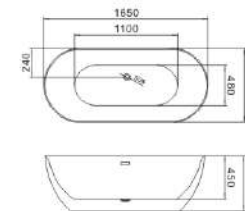

以上浴缸牌價皆不含龍頭及其他配件,所有浴缸搬運費另計

期



• **SL-1086(空缸)**  
Size: 1600x800x660mm  
List Price: **\$ 138,000.(空缸)**  
Capacity: 40 litres to rim,  
with overflow 50 litres

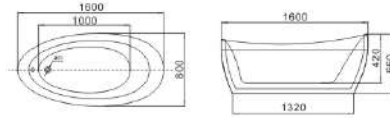

期



• **SL-1073(空缸)**  
Size: 1700x800x600mm  
List Price: **\$ 135,000.(空缸)**  
Capacity: 45 litres to rim,  
with overflow 55 litres

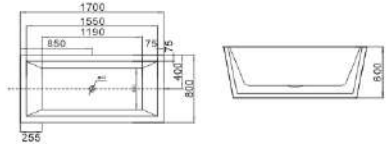

期



浴缸 Bathtubs  
• **BA1490(空缸) BA1490T(按摩浴缸)**  
Size: 1490x1490x570mm  
Capacity: 65 litres to rim,  
with overflow 75 litres  
Color: White only  
Embedded Installation  
List Price: **\$ 32,800.(空缸) \$ 73,800.(按摩浴缸)**

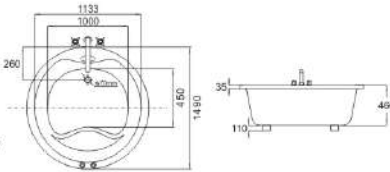

期



浴缸 Bathtubs  
• **BA1250(空缸) BA1250T(按摩浴缸)**  
Size: 1250x1250x560mm  
Capacity: 65 litres to rim,  
with overflow 65 litres  
Color: White only  
Embedded Installation  
List Price: **\$ 26,700.(空缸) \$ 67,700.(按摩浴缸)**

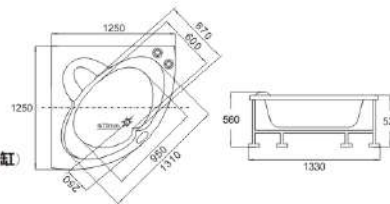

期



浴缸 Bathtubs  
• **BA1810(空缸) BA1810T(按摩浴缸)**  
Size: 1800x1000x550mm  
Capacity: 60 litres to rim,  
with overflow 68 litres  
Color: White only  
Embedded Installation  
List Price: **\$ 32,800.(空缸) \$ 73,800.(按摩浴缸)**

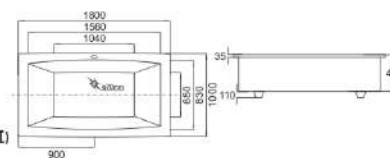

浴缸牌價皆不含龍頭及其他配件,所有浴缸搬運費另計

期



浴缸 Bathtubs  
• **BA1473(空缸) BA1473T(按摩浴缸)**  
Size: 1400x730x530mm  
List Price: **\$ 12,300.(空缸) \$ 55,300.(按摩浴缸)**  
Capacity: 45 litres to rim,  
with overflow 49 litres  
• **BA1573(空缸) BA1573T(按摩浴缸)**  
Size: 1500x730x530mm  
List Price: **\$ 12,300.(空缸) \$ 55,300.(按摩浴缸)**  
Capacity: 48 litres to rim,  
with overflow 53 litres  
• **BA1673(空缸) BA1673T(按摩浴缸)**  
Size: 1600x730x530mm  
List Price: **\$ 16,400.(空缸) \$ 59,400.(按摩浴缸)**  
Capacity: 52 litres to rim,  
with overflow 56 litres  
Color: White only  
Embedded Installation

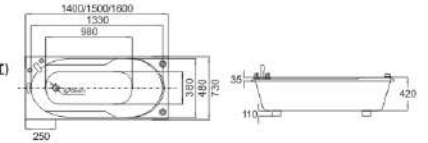

期



浴缸 Bathtubs  
• **BA1575(空缸) BA1575T(按摩浴缸)**  
Size: 1500x750x510mm  
List Price: **\$ 14,400.(空缸) \$ 57,400.(按摩浴缸)**  
Capacity: 48 litres to rim,  
with overflow 55 litres  
• **BA1675(空缸) BA1675T(按摩浴缸)**  
Size: 1600x750x510mm  
List Price: **\$ 17,400.(空缸) \$ 59,400.(按摩浴缸)**  
Capacity: 55 litres to rim,  
with overflow 63 litres  
• **BA1585(空缸) BA1585T(按摩浴缸)**  
Size: 1500x850x510mm  
List Price: **\$ 22,600.(空缸) \$ 65,600.(按摩浴缸)**  
Capacity: 58 litres to rim,  
with overflow 66 litres  
Color: White only  
Embedded Installation

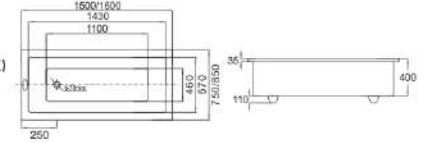

期



浴缸 Bathtubs  
• **BA1812(空缸) BA1812T(按摩浴缸)**  
Size: 1800x1200x600mm  
List Price: **\$ 43,000.(空缸) \$ 94,300.(按摩浴缸)**  
Capacity: 92 litres to rim,  
with overflow 110 litres  
• **BA1712(空缸) BA1712T(按摩浴缸)**  
Size: 1700x1200x600mm  
List Price: **\$ 43,000.(空缸) \$ 94,300.(按摩浴缸)**  
Capacity: 78 litres to rim,  
with overflow 90 litres  
Color: White only  
Embedded Installation

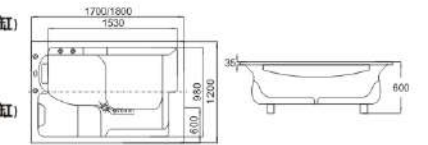

壓克力板材優勢

壓克力化學名稱叫聚甲基丙烯酸甲酯 (PMMA), 俗稱有機玻璃。廣泛用於燈箱廣告、衛浴潔具、航空工業。KARAT 壓克力浴缸使用潔具專用的新料不摻舊料, 比使用普通壓克力板或者複合板在硬度與光潔度上都要高, 色彩也最穩定。



樹脂原材料優勢

使用環保型樹脂, 固化完全, 不釋放有害氣。樹脂粘結性好, 不容易分層或脫膠。經過80°C水蒸實驗, 100小時後不變色或褪色。



5件套龍頭配件的優勢

選用高質量的陶瓷閥芯, 60萬次開起閉壽命所有鍍鉻配件均經96小時鹽霧試驗。



# Art Innovation Life

針對每一種裝潢風格和用途，  
都可以找到相匹配的產品。  
完美無瑕的展現，讓家活躍起來.....



Accessories  
浴室配件

LED

除霧鏡

智慧LED無汞  
環保除霧鏡  
安全防水接頭

New

防水 / 防霧 / 防潮 / 防鏽 / 防腐 / 防污垢

全系列觸控LED除霧鏡/鏡櫃均採安全防水接頭

### KARAT 最新電容式觸摸

- 此款開關是採用最新的電容式觸摸，且觸摸開關還帶有超低功耗LED背光屏，確保開關在待機狀態功耗只有0.1W。觸摸科技應用，高貴、優雅、新穎、耐用。電容式感應觸摸開關可以穿透絕緣材料外殼20mm(玻璃、塑膠等等)以上，準確無誤地偵測到手指的有效觸摸。並保證了產品的靈敏度、穩定性、可靠性等不會因環境條件的改變或長期使用而發生變化，並具有防水和強抗干擾能力。
- 相比傳統金屬觸摸或機械開關：  
電容式感應觸摸開關不需要人體直接接觸金屬，可以徹底消除安全隱患，即使帶手套也可以使用，並且不受天氣乾燥潮濕人體電阻變化等影響，使用更加方便。沒有任何機械部件，不會磨損，無限壽命，減少後期維護成本。

### KARAT 產品說明：

- 鋁合金背框，不同顏色的選擇，滿足您個性化的需求。
- 鏡面採用第三代無汞環保鏡，更適合潮濕的浴室環境。
- 清晰的照明體驗，營造舒適的光照環境，將梳妝和LED燈二合一。
- 鏡面的觸摸開關，新增時尚感的同时，能更好的滿足您對燈光不同亮度的需求。
- 特殊功能：防水防霧防潮防鏽防腐防污垢
- 產品特點：簡潔、易搭配，易清潔安裝，打破了原有居家風格的沉悶和單調，為居室空間注入新活力。
- 日常維護與保養：軟布或羽毛揮去鏡框表面的灰塵；用清潔柔軟的濕布接觸鏡框表面，輕輕擦洗；鏡面如出現污漬或不明亮，可用玻璃清潔劑噴在鏡片，再用報紙擦拭，處理頑固污漬可用牙膏或30%的清潔稀釋液擦拭；

觸控



黃色



白色

智慧雙色LED無汞環保除霧鏡  
可自行調黃光或白光

型號	尺寸(MM)	牌價(NTD)
MB-6080L	600X800	16,500
MB-8080L	800X800	18,500
MB-9080L	900X800	20,500
MB-10080L	1000X800	22,500

620 / 820 / 920 / 1020



- 材質：鋁合金+第三代無汞環保鏡
- 輸入電壓：110-240V 50/60HZ
- 負載功率：LED燈100W,
- 最大工作環境溫度：45度
- 開關壽命週期至少：10000次
- 觸摸管道：電容式最大穿透玻璃介質5mm
- 產品通過：CE安全認證



智慧雙色LED無汞環保除霧鏡櫃  
可自行調黃光或白光

100%防水緩開鉸鏈

型號	尺寸(MM)	牌價(NTD)
NC-6080L-R 鉸鏈在右邊	600X800	25,800
NC-6080L-L 鉸鏈在左邊	600X800	25,800



黃色



白色

- 材質：鋁合金+第三代無汞環保鏡
- 輸入電壓：110-240V 50/60HZ
- 負載功率：LED燈100W,
- 最大工作環境溫度：45度
- 開關壽命週期至少：10000次
- 觸摸管道：電容式最大穿透玻璃介質5mm
- 產品通過：CE安全認證

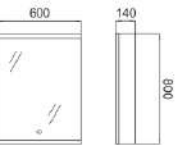



**NC-4874** PVC

- 防水鏡櫃
- Size: 450x120x600mm
- Fixing to wall with back
- List Price: **\$ 11,500.**

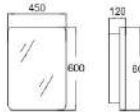

**MF-4912** MF-4922

- 防水實木框防霧鏡
- Size: 723x20x923mm
- Size: 572x20x720mm
- Fixing to wall with back
- List Price: **\$ 7,000.**
- List Price: **\$ 5,000.**

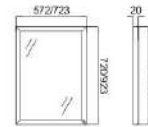

**MF-4932** MF-4942

- 防水實木框防霧鏡
- Size: 723x20x923mm
- Size: 572x20x720mm
- Fixing to wall with back
- List Price: **\$ 7,000.**
- List Price: **\$ 5,000.**

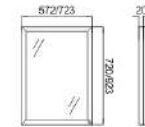

**MF-4926F**

- 防水實木黑框紋防霧鏡
- Size: 600x20x800mm
- Fixing to wall with back
- List Price: **\$ 5,800.**

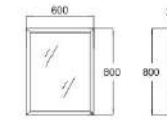

**MF-4926H** MF-4936H

- 防水實木啞光防霧鏡
- Size: 600x20x800mm
- Size: 500x20x750mm
- Fixing to wall with back
- List Price: **\$ 5,800.**
- List Price: **\$ 5,600.**

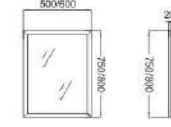

**NC-4827G** PVC

- 防水鏡櫃 (白色烤漆)
- Size: 480x120x750mm
- Fixing to wall with back
- List Price: **\$ 13,100.**

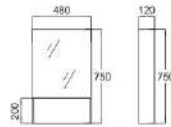

**NC-4827G-CB** PVC

- 防水鏡櫃 (PCV貼皮)
- Size: 480x120x750mm
- Fixing to wall with back
- List Price: **\$ 13,000.**

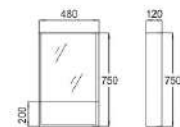

**NC-4837G-CB** PVC

鏡門可左右對換

- 防水鏡櫃 (PCV貼皮)
- Size: 680x120x700mm
- Fixing to wall with back
- List Price: **\$ 19,800.**

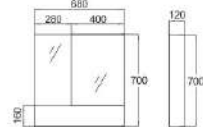

**NC-4839G-CH** PVC

- 防水鏡櫃 (PCV貼皮)
- Size: 750x150x700mm
- Fixing to wall with back
- List Price: **\$ 16,000.**



**NC-4811** PVC

- 防水鏡櫃
- Size: 650x140x800mm
- Fixing to wall with back
- List Price: **\$ 18,000.**

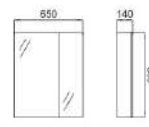

**NF-4958** NF-4959

- 白色棉木框鏡(附平台)
- Size: 500x120x840mm
- Size: 680x140x900mm
- Fixing to wall with back
- List Price: **\$ 8,800.**
- List Price: **\$ 9,800.**

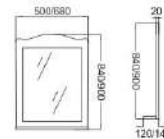

**MB-4822G** 橫式

**MB-4822G-1** 直式

**MB-4812G** 橫式

**MB-4812G-1** 直式

- 除霧明鏡
- Size: 600x450mm
- Size: 800x600mm
- Fixing to wall with back
- List Price: **\$ 1,800.**
- List Price: **\$ 3,000.**

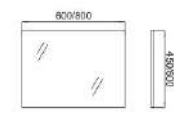

**MB-4833BG** 直式

**MB-4834BG** 直式

- 明鏡(社福用,無除霧)
- Size: 600x900mm
- Size: 500x800mm
- Fixing to wall with back
- List Price: **\$ 5,000.**
- List Price: **\$ 4,500.**

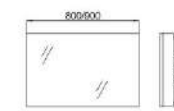

**NB-4601**

- 摺疊放大鏡
- List Price: **\$ 4,500.**

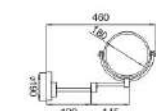

LED  
乾燥機

KB-1351 (有線)  
KB-1352 (無線)

LED MULTI-FUNCTION  
DRYER  
FAN SERIES

LED面板多功能乾燥機

色彩對人類心理的極其影響已經得到了醫學界的證實，而燈光也被成功地用於各種治療，繽紛燈光也可在家中或浴室內用來促進放鬆，提高舒適感。KARAT LED多功能乾燥機擁有溫馨的LED燈光，可營造出寧靜、舒緩的浴室氛圍。

## LED面板多功能乾燥機

LED MULTI-FUNCTION DRYER FAN SERIES

炫彩簡約俐落弧線型面板！



附7米控制線

- 首創業界「LED功能識別燈」時尚炫麗的LED面板。每一不同功能搭配不同顏色，用顏色來區分功能，繽紛活潑的色彩生活美學。
- 內建多項功能鍵，可預約時間啟動各功能。
- 換氣、暖房、乾燥、涼風、外接照明五種功能。
- 細微珍珠粉烤漆面板質感瞬間提升，外觀保護層塗料避免長時間空氣氧化，方便好清潔。
- 採用PTC(陶瓷電阻)加熱安全設計，同時有7層安全過熱保護裝置，馬達有獨立溫度保險絲，及NTC(溫度偵測棒)會自動斷電，出風口處採用耐熱材質，以確保使用上安全無慮；此外，本公司所有產品皆通過經濟部標準檢驗局(BSMI)認證，CE認證及ISO9001國際認證，更榮獲MIT微笑標章品質有保證。
- 抽取式濾網的設計，方便主婦們清洗。
- 分離式排風口接口設計，不受限於施工現場環境的方向，安裝更簡便、更容易。

ACCESSORY 209 210

· 公共配件系列 ·



- 型號 Model **KB-1351 (有線)**  
**KB-1352 (無線)**
- 電壓 Voltage AC110V/60Hz  
AC-220V (可訂製)
- 安倍 Amp 11.2
- 功率 Power 1230W
- 面板尺寸(mm) 484x364mm
- 安裝尺寸(mm) 425x295
- 安裝高度(mm) 200mm以上
- 排風口徑(mm) 100mm
- 牌價 List Price **\$30,000(有線)**  
**\$36,000(無線)**

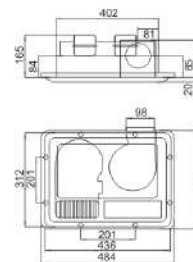

浴室換氣暖房乾燥機-功能色系變換: 功能識別燈--不同功能顯示不同顏色燈

照光明(白色)

換氣(綠色)

涼風(藍色)

暖風(黃色)

乾燥(紫色)



產品功能顯示:

- ☐ 乾燥模式
- ☐ 涼風模式
- H☐ 強換氣模式
- L☐ 標準換氣模式
- H☐ 強預暖模式
- L☐ 標準預暖模式



觸控面板(遙控操作)



觸控面板(有線)



吸頂式

掛窗式

掛牆式

## MINI 3 WAY 暖風乾燥機

MINI 3 WAY BATHROOM HEATING FAN

型號 Model	<b>KB-1241</b>
電壓 Voltage	110V 60HZ 4.55A / 500W (不含外接照明) 220V 60HZ 2.27A / 500W (不含外接照明) 100CMH / 可拆式濾網
面板尺寸(mm)	275x275
安裝尺寸(mm)	210x210x180
牌價 List Price	<b>\$26,000.</b>

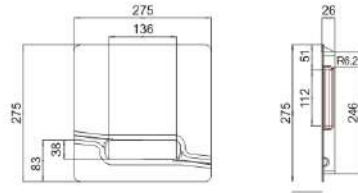

## 側吸式面板 進風更全面

杜絕強風倒灌噪音,異味不逆流,保持浴室空氣清新

## PRODUCT FEATURES

## 產品特點

側吸面板  
兩個大角度進風

## 緊急獨立開關

當無線/有線控制器損壞時,  
暫時的控制機制

## 陶瓷電阻(PTC)加熱器

搭配使用耐熱材質出風口,內  
建獨立溫度保險絲及溫度偵  
測器(NTC),同時有7層安全  
過熱保護裝置,確保使用安全  
無憂

## 簡約俐落型面板



## 無線遙控器

面板尺寸(mm) 128x78x15  
使用電池 CR2032電池

## 浴室通風扇

VENTILATION FAN

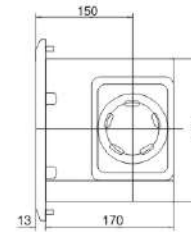

型號 Model	<b>KB-1086</b>
電壓 Voltage	AC-110V/60HZ AC-220V (可訂製)
安培 Amp	0.16
最大風量 Air	110
額定電流 Power	18W
噪音 Noise	39DBA
重量 Weight	1.2KG
平均排風量 Exhaust rate	96(m <sup>3</sup> /hr)
最大排風量 Exhaust rate	110(m <sup>3</sup> /hr)
排風尺寸(mm)	Φ100
安裝尺寸(mm)	210x210x170
牌價 List Price	<b>\$2,500.</b>



## 培林軸承馬達壽命5萬小時以上

(一般市售產品大多無培林軸承,使用壽命短)



## KH-2005

• 烘手機 (嵌牆不鏽鋼)  
List Price: **\$27,000.**  
Size: 340x361x156mm

## 起訂量32台

## KH-3005

• 烘手機 (外露不鏽鋼)  
List Price: **\$31,000.**  
Size: 320x175x220mm





鋅合金系列

				
				
<b>K-6941</b> • 掛衣鉤 List Price: \$ 840.	<b>K-6942</b> • 杯架組 List Price: \$ 1050.	<b>K-6943</b> • 肥皂架組 List Price: \$ 1,200.	<b>K-6944</b> • 化妝平臺 List Price: \$ 1,650.	<b>K-6945</b> • 衛生紙架 List Price: \$ 1,300.

				
				
<b>K-6946</b> • 毛巾環 List Price: \$ 1,200.	<b>K-6947</b> • 單桿毛巾架 List Price: \$ 1,800.	<b>K-6947D</b> • 雙桿毛巾架 List Price: \$ 2,500.	<b>K-6948</b> • 馬桶刷座組 List Price: \$ 1,900.	<b>K-6949</b> • 置物架 List Price: \$ 3,800.

銅鍍鉻系列

				
				
<b>K-6211</b> • 掛衣鉤 List Price: \$ 1,400.	<b>K-6212</b> • 杯架組 List Price: \$ 2,100.	<b>K-6213</b> • 肥皂架組 List Price: \$ 2,200.	<b>K-6214</b> • 化妝平臺 List Price: \$ 3,800.	<b>K-6216</b> • 毛巾環 List Price: \$ 2,000.

			
			
<b>K-6217</b> • 單桿毛巾架 List Price: \$ 3,600.	<b>K-6217D</b> • 雙桿毛巾架 List Price: \$ 5,000.	<b>K-6218</b> • 馬桶刷座組 List Price: \$ 3,100.	<b>K-6219</b> • 置物架 List Price: \$ 10,400.

ABS鍍鉻系列

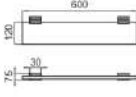

<b>K-6584</b> • 化妝平臺 List Price: \$ 800.

瓷器製系列

		
		
<b>K-0027</b> • 紙巾架 List Price: \$ 900.	<b>K-0063</b> • 皂盤 List Price: \$ 500.	<b>K-0155</b> • 掛衣鉤 List Price: \$ 700.
		
		
<b>K-0025</b> • 單桿毛巾架 (60公分) List Price: \$ 1,400.	<b>K-0021</b> • 化妝平臺 (45公分) List Price: \$ 2,000.	<b>K-0018</b> • 馬桶刷座組 List Price: \$ 1,200.

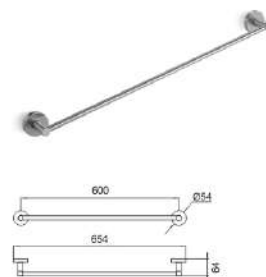
不鏽鋼系列-拉絲



**SB-1027**  
• 單桿毛巾架 (60公分)  
List Price: \$ 2,000.

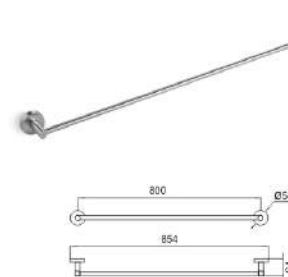

**SB-1027-1**  
• 單桿毛巾架 (80公分)  
List Price: \$ 2,800.

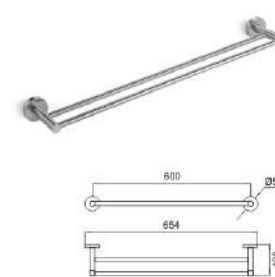

**SB-1027D**  
• 雙桿毛巾架  
List Price: \$ 2,800.



**SB-1091D**  
• 雙鉤掛衣鉤  
List Price: \$ 1,300.

**SB-1062**  
• 杯架組  
List Price: \$ 1,500.

**SB-1062D**  
• 雙杯架組  
List Price: \$ 2,200.

**SB-1073**  
• 肥皂架組  
List Price: \$ 1,500.

**SB-1054**  
• 化妝平臺  
List Price: \$ 3,200.

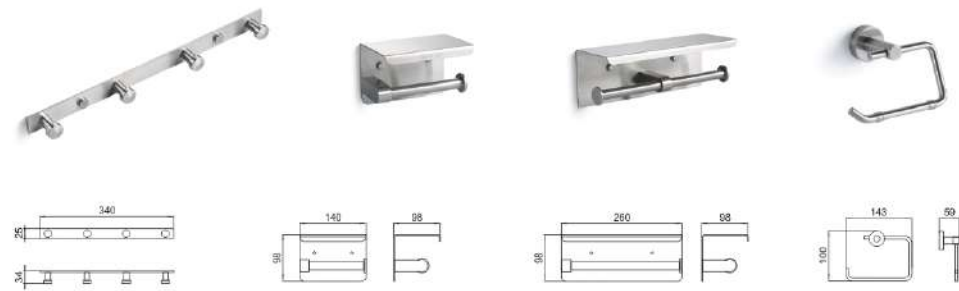

**SB-6091**  
• 圓形掛衣鉤  
List Price: \$ 2,000.

**SB-3105**  
• 衛生紙架  
List Price: \$ 2,800.

**SB-3105D**  
• 雙格衛生紙架  
List Price: \$ 4,900.

**SB-1046**  
• 毛巾環  
List Price: \$ 1,800.

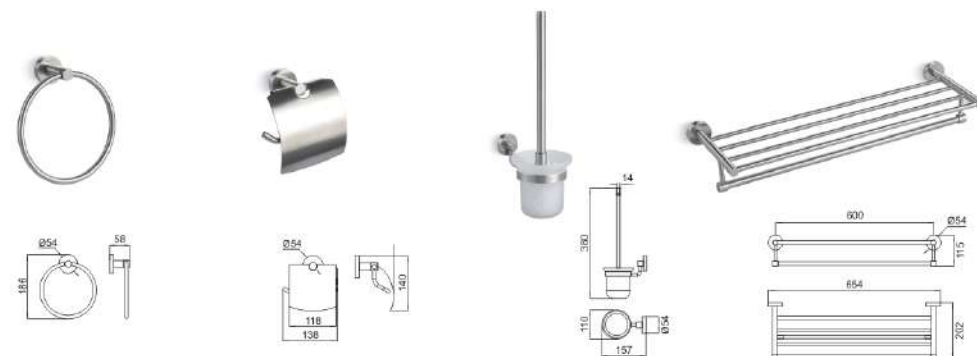

**SB-1036**  
• 毛巾環  
List Price: \$ 1,400.

**SB-1045**  
• 衛生紙架  
List Price: \$ 2,000.

**SB-6108**  
• 馬桶刷座組  
List Price: \$ 2,000.

**SB-1019**  
• 雙層置物架  
List Price: \$ 4,500.

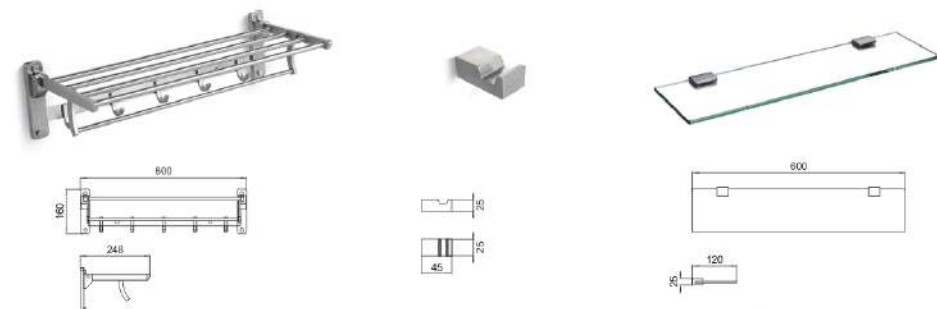

**SB-1511**  
• 雙層折疊置物架  
List Price: \$ 6,200.

**SB-6291**  
• 掛衣鉤  
List Price: \$ 800.

**SB-6154**  
• 化妝平臺  
(不鏽鋼平台夾+ 強化玻璃化妝平台)  
List Price: \$ 2,500.

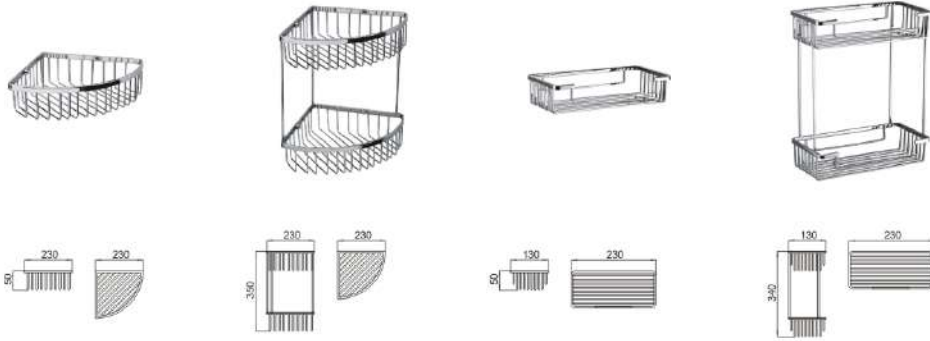

**SC-2605**

• 不鏽鋼置物架  
Size: 230x230x50mm  
List Price: **\$ 2,000.**

**SC-2625**

• 不鏽鋼置物架  
Size: 230x230x350mm  
List Price: **\$ 4,200.**

**SC-2601**

• 不鏽鋼置物架  
Size: 230x130x50mm  
List Price: **\$ 2,200.**

**SC-2621**

• 不鏽鋼置物架  
Size: 230x130x340mm  
List Price: **\$ 3,900.**



**SC-2608**

• 不鏽鋼置物架  
Size: 230x230x50mm  
List Price: **\$ 2,400.**

**SC-1019**

• 不鏽鋼置衣架  
Size: 622x220x190mm  
List Price: **\$ 3,900.**

**SC-2611**

• 不鏽鋼置衣架  
Size: 600x235x150mm  
List Price: **\$ 2,000.**



**SC-1027**

• 不鏽鋼單桿毛巾架  
Size: 600x80x50mm  
List Price: **\$ 1,800.**

**SC-1037**

• 不鏽鋼單桿毛巾架  
Size: 600x80x50mm  
List Price: **\$ 1,800.**

**SB-6401**

• 掛衣鈎  
Size: 81x59x53mm  
List Price: **\$ 1,800.**



**SB-1028**

• 肥皂架組  
List Price: **\$ 800.**

**SC-3105A**

• 不鏽鋼衛生紙架  
Size: 155x100x100mm  
List Price: **\$ 2,200.**

**SC-3106**

• 不鏽鋼盒裝衛生紙架  
Size: 243x123x100mm  
List Price: **\$ 2,800.**



## KF-2006HZ 乾手機

## 雙面噴射式乾手機

利用直流無刷電機技術，高效節能，壽命長，利用雙面高速氣流5-7秒迅速吹乾雙手。

## 使用方法

- 將雙手張開一直伸向深處，機器自動開始運轉。
- 慢慢的向收回雙手，讓風吹掉手上的水滴。
- 直至手指尖收回。
- 大約5-7秒鐘時間。

## 健康生活·源於雙手



## KF2006HZ

## • 噴射式乾手機

List Price: \$ 65,000.

功率: 1650W

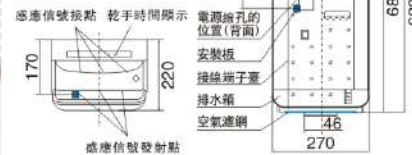

## DC無刷電機，一天1,000次使用壽命可達7至10年

## 雙面噴射的高速氣流

乾手的速度和風速×風量成比例。在繼承了執著於速乾的雙面噴射的同時，也不斷地改進着噴嘴的形狀。

快速
乾手時間 約5~7秒
風速85~100m/秒
風量3.6m <sup>3</sup> /分鐘

## 穩定的運轉、使用壽命長。

## DC無接觸式無刷電機

裝配了可以1天使用1,000次擁有連續7年耐久性的DC無接觸式電動機(小巧型)。由於不發生電刷和電動機之間的磨損，可以得到強效的動力，保持長時間的穩定運轉。

壽命
1天1000次運轉 長達約7-10年時間

## 確切的啟動&amp;停止

## 三傳感器阻斷感應方式

當只要手掌自上而下或自外而內進入乾手區域阻斷三個傳感器的其中一個或多個，機器立即啟動。手掌上抽或向外移出，機器立即停止，乾淨衛生。



## 新開發的頂級噴嘴

通過採用兩面弓型的狹長扁形縫孔的新噴嘴，減少了吹到手上的風所受的阻礙，提高了烘乾的效率。利用噴射的薄膜狀的魔法的風，一下子就可以將手上的水滴吹乾。

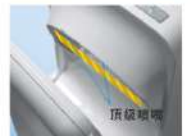

## 兩側開放式設計

## 從旁側也可將手插入

## 人性工程學的設計：

兩側面為開放式設計，不會有擔心手掌觸碰側壁的壓迫感，從旁側也可自然的將手插入。從旁側將手插入，慢慢向上抽出的動作。重複2-3次，可以更好的烘乾還可以控制水滴的反濺。



## 以自然的姿勢輕鬆使用。

## 輕鬆的姿勢

在靠近身體一側設置了適合的傾角(約15度)，可以以自然的姿勢將手放入。





**DONNY 懂你**  
**K-2275T**

• 全智能馬桶 (社福用)  
Intelligent toilet  
Size: 710x385x520mm  
S-trap: 300/400mm Roughing-in  
List Price: **\$ 115,000.**  
適用水壓範圍: 0.5kgf/cm<sup>2</sup>~7.5kgf/cm<sup>2</sup>

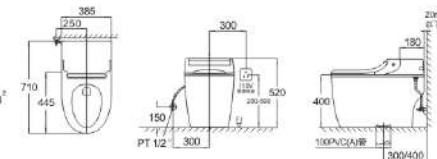

**HAITANG 海棠**  
**K-5558+DK-2221**

• 感應式兩段沖水直沖式落地馬桶 (社福用馬桶蓋)  
Wash down toilet  
Size: 535x370x395mm  
S-trap: 300/400mm Roughing-in  
適用水壓/water pressure available:  
0.3kgf/cm<sup>2</sup>~7.5kgf/cm<sup>2</sup>  
List Price: **\$ 22,000+ \$ 22,000.**

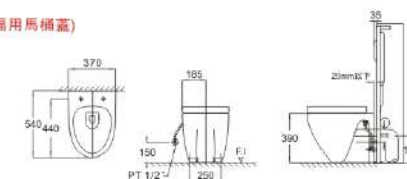

合計: **\$ 44,000.**

**JIEYAO 潔瑤**  
**K-8896F+DK-331**

• 虹吸式快沖式馬桶 (社福用馬桶蓋)  
Siphonic toilet  
Size: 690x385x400mm  
S-trap: 300/400mm Roughing-in  
List Price: **\$ 14,000.+ \$ 8,100.**

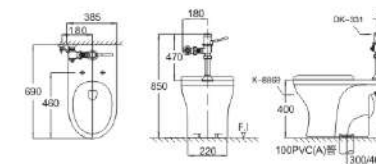

合計: **\$ 22,100.**

**MAJI 麻吉**  
**K-8658F+DK-331**

• 虹吸式快沖式馬桶 (社福用馬桶蓋)  
Siphonic toilet  
Size: 650x350x400mm  
S-trap: 300/400mm Roughing-in  
List Price: **\$ 10,900.+ \$ 8,100.**

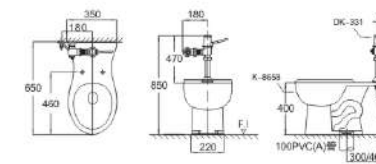

合計: **\$ 19,000.**

抗菌扶手系列

特點

ABS抗菌奈米材質  
內嵌鉛管,固定座為不鏽鋼  
美觀、大方、觸摸不冰冷

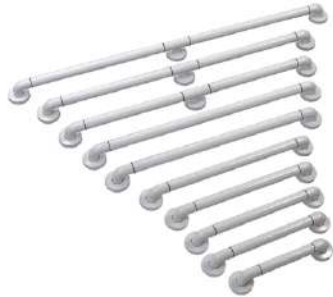

**KH-6121B** C型抗菌扶手

- Size: 120公分 \$ 5,800.
- Size: 100公分 \$ 5,400.
- Size: 90公分 \$ 4,900.
- Size: 80公分 \$ 4,400.
- Size: 70公分 \$ 4,000.
- Size: 60公分 \$ 3,500.
- Size: 50公分 \$ 3,100.
- Size: 40公分 \$ 2,900.
- Size: 30公分 \$ 2,400.



◀ 依客人需要訂製尺寸  
連續型抗菌扶手

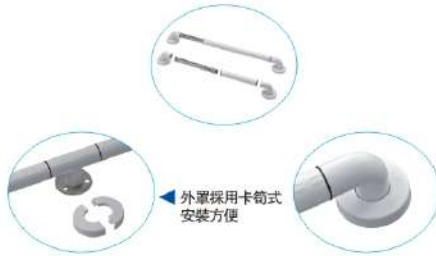

◀ 外罩採用卡筍式  
安裝方便



**KH-6158B** · 活動馬桶抗菌扶手  
List Price: \$ 18,000.  
Size: 700x120x220mm



**KH-6111B** · W型面盆抗菌扶手  
List Price: \$ 19,000.  
Size: 650x520x300mm



**KH-6141B** · 小便斗抗菌扶手  
List Price: \$ 22,000.  
Size: 600x550x500mm



**KH-6110B** · P型面盆抗菌扶手  
List Price: \$ 29,000.  
Size: 700x750mm



**KH-6150B** · L型馬桶抗菌扶手  
List Price: \$ 7,900.  
Size: 700x700mm



**KH-6159B** · V型斜臂抗菌扶手  
List Price: \$ 6,500.  
Size: 400x400mm



公共浴廁用產品



**KH-6111** · 面盆扶手  
List Price: \$ 9,000.  
Size: 650x300x520mm



**KH-6141** · 便斗扶手  
List Price: \$ 9,900.  
Size: 600x550x550mm



**KH-6175** · 背墊  
List Price: \$ 7,600.  
Size: 402x255x290mm



**KH-6121** · 一字型扶手  
Size: 300x100mm  
Size: 600x100mm  
Size: 900x100mm  
Size: 1200x100mm  
List Price: \$ 1,000.  
List Price: \$ 1,400.  
List Price: \$ 2,500.  
List Price: \$ 3,400.



**KH-6150** · L型扶手  
List Price: \$ 6,600.  
Size: 700x700x100mm



**KH-6110** · P型面盆扶手  
List Price: \$ 10,000.  
Size: 700x750mm



**KH-6158** · 活動扶手  
List Price: \$ 12,000.  
Size: 107x207x750mm

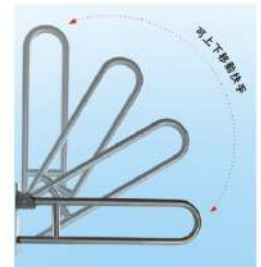



**KF-1060**

• 衛生紙架(單捲)  
List Price: **\$ 600.**  
Size:130x70x80mm



**KF-8011**

• 衛生紙架(雙捲)  
Price: **\$ 6,000.**  
Size:457x105x127mm



**KF-9025**

• 衛生紙架(大捲)  
List Price: **\$ 4,300.**  
Size:270x110mm



**KF-3025**

• 衛生紙架(大捲)  
List Price: **\$ 1,400.**



**SK-5311**

• 紙盒架  
List Price: **\$ 1,600.**  
Size:240x125x150mm



**KF-1666**

• 壓克力抽取式紙架  
List Price: **\$ 1,500.**  
Size:260x120x135mm



**KF-1667**

• 壓克力抽取式紙架  
List Price: **\$ 1,200.**  
Size:265x125x165mm



**KF-1918**

• 平版紙架  
List Price: **\$ 1,300.**  
Size:240x115x205mm



**KF-5014**

• 擦手紙箱 (嵌牆不鏽鋼)  
List Price: **\$ 18,000.**  
Size:330x440x102mm



**KF-9018**

• 擦手紙箱 (小)  
List Price: **\$ 3,300.**  
Size:330x440x102mm



**KF-9028**

• 擦手紙箱 (不鏽鋼)  
List Price: **\$ 4,500.**  
Size:280x370x102mm



**KF-5016**

• 擦手紙箱附垃圾筒 (嵌牆不鏽鋼)  
List Price: **\$ 48,000.**  
Size:337x1400x105mm



**KE-1700**

• 淋浴椅(不鏽鋼)  
List Price: **\$ 10,800.**  
Size:400x320x452mm



**KF-003**

• 圓型投紙口(無蓋)  
List Price: **\$ 2,000.**



**KS-6028**

• 按壓給皂機  
List Price: **\$ 3,300.**  
出皂口: 6"



**KS-6028S**

• 按壓給皂機 (不鏽鋼)  
List Price: **\$ 5,100.**  
出皂口: 6"



**K-6002**

• 門檔掛衣鉤  
List Price: **\$ 450.**



## Children

高科技含量衛浴並非是設計的終端，而真正的目的在於從科技到關愛。設計是為了創造更為人性化的產品，關愛生活的每一處細節，而衡量人性化的標準就是對衛浴使用者的關愛程度。



MINOR 米羅  
**K-2742 (幼童專用馬桶)**

(不適用加裝智能馬桶座)

- 噴射虹吸式分體馬桶
- Siphonic two-piece toilet
- Size: 510x350x650mm
- S-trap: 100mm Roughing-in
- P-trap: 150mm Roughing-in
- 適用水壓/water pressure available : 0.3kgf/cm<sup>2</sup>~7.5kgf/cm<sup>2</sup>
- List Price: **\$ 14,400.**

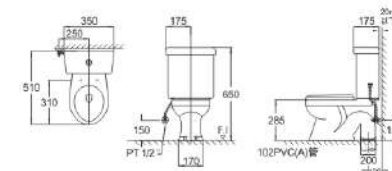

**K-3651/SH-02**

• 掛式小便斗 (幼童可用)

- Hanging urinal
- Size: 310x270x420mm
- Fixing to wall with back
- List Price: 瓷 **\$ 7,800.** / 陶 **\$ 2,800.**
- 掛牆排、地排兩用式

★ 註明“不含排水零件”

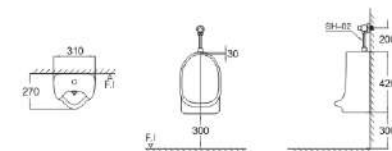

**KD-9008**

- 嬰兒安全座椅
- Hanging baby hseat
- Size: 305x254x483mm
- Fixing to wall with back
- List Price: **\$ 16,800.**

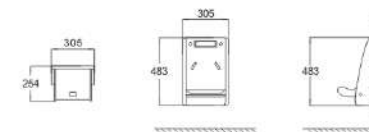

## KARAT 凱樂



**KD-9012**

- 嬰兒尿布床
- Hanging baby diaper bed
- Size: 920x570x100mm
- Size: 920x570x520mm
- Fixing to wall with back
- List Price: **\$ 39,200.**

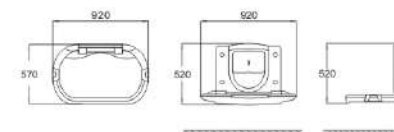





- FR-3015 1 1/2吋, 高龍型落水頭 \$ 650.
- FR-3020 2吋, 高龍型落水頭 \$ 650.
- FR-3025 2 1/2吋, 高龍型落水頭 \$ 750.
- FR-3030 3吋, 高龍型落水頭 \$ 850.
- FR-3040 4吋, 高龍型落水頭 \$ 2,100.
- FR-3050 5吋, 高龍型落水頭 \$ 2,400.
- FR-3060 6吋, 高龍型落水頭 \$ 3,800.



- FR-6015 1 1/2吋, 高龍型落水頭附網罩 \$ 1,100.
- FR-6020 2吋, 高龍型落水頭附網罩 \$ 1,200.
- FR-6025 2 1/2吋, 高龍型落水頭附網罩 \$ 1,300.
- FR-6030 3吋, 高龍型落水頭附網罩 \$ 1,400.
- FR-6040 4吋, 高龍型落水頭附網罩 \$ 2,750.



- FC-5020 2吋, 清潔口 \$ 600.
- FC-5030 3吋, 清潔口 \$ 700.
- FC-5040 4吋, 清潔口 \$ 800.
- FC-5050 5吋, 清潔口 \$ 1,000.
- FC-5060 6吋, 清潔口 \$ 1,300.
- FC-5080 8吋, 清潔口 \$ 5,200.



- FC-3020 2吋, 清潔口 \$ 600.
- FC-3030 3吋, 清潔口 \$ 700.
- FC-3040 4吋, 清潔口 \$ 800.
- FC-3050 5吋, 清潔口 \$ 1,000.
- FC-3060 6吋, 清潔口 \$ 1,300.
- FC-3080 8吋, 清潔口 \$ 5,200.



- FL-5015 1 1/2吋, 地板落水片 \$ 180.
- FL-5020 2吋, 地板落水片 \$ 200.
- FL-5025 2 1/2吋, 地板落水片 \$ 350.
- FL-5030 3吋, 地板落水片 \$ 550.



- FL-1515  
地板落水頭  
Size: 150x150mm  
List Price: \$ 1,350.



- FL-2020  
地板落水頭  
Size: 200x200mm  
List Price: \$ 2,750.



- FL-6020 2吋, 地板落水頭 \$ 250.
- FL-6025 2 1/2吋, 地板落水頭 \$ 500.
- FL-6030 3吋, 地板落水頭 \$ 550.



- FL-7015 1 1/2吋, 地板落水頭 (防臭) \$ 650.
- FL-7020 2吋, 地板落水頭 (防臭) \$ 650.
- FL-7030 3吋, 地板落水頭 (防臭) \$ 1,000.



- FL-1010ST-1  
不鏽鋼地盤落水頭  
Size: 100x100mm  
List Price: \$ 780.



- FL-1010ST-2  
不鏽鋼地盤落水頭  
Size: 100x100mm  
List Price: \$ 780.



- 不鏽鋼集水槽
- SW-1020 Size: 200x100mm \$ 1,500.
- SW-1030 Size: 300x100mm \$ 1,800.
- SW-1040 Size: 400x100mm \$ 2,100.
- SW-1050 Size: 500x100mm \$ 2,500.
- SW-1060 Size: 600x100mm \$ 2,900.



- FL-1010ST-3  
不鏽鋼隱形落水頭(表面可貼磁磚)  
Size: 100x100mm  
List Price: \$ 880.



- 不鏽鋼隱形集水槽(表面可貼磁磚)
- FE-8018 Size: 80x180mm \$ 1,200.
- FE-8028 Size: 80x280mm \$ 1,600.
- FE-8058 Size: 80x580mm \$ 2,600.



- FH-1005 1/2吋, 高壓浮球凡爾 \$ 880.
- FH-1007 3/4吋, 高壓浮球凡爾 \$ 990.
- FH-1010 1吋, 高壓浮球凡爾 \$ 1,200.
- FH-1012 1 1/4吋, 高壓浮球凡爾 \$ 3,600.
- FH-1015 1 1/2吋, 高壓浮球凡爾 \$ 8,000.
- FH-1020 2吋, 高壓浮球凡爾 \$ 9,900.
- FH-1025 2 1/2吋, 高壓浮球凡爾 \$ 16,500.
- FH-1030 3吋, 高壓浮球凡爾 \$ 23,000.
- FH-1040 4吋, 高壓浮球凡爾 \$ 39,500.



- KA-126RD  
無線感應 [直沖閥式]  
List Price: \$ 27,000.



- DK-323  
蹲式手壓快沖器  
List Price: \$ 8,000.



- DK-322  
蹲式手壓快沖器(二段式)  
List Price: \$ 9,000.



- DK-332  
蹲式腳踏快沖器  
List Price: \$ 8,000.



- DK-333  
蹲式腳踏快沖器(二段式)  
List Price: \$ 9,000.



- DK-331  
坐式手壓快沖器  
List Price: \$ 8,100.



- DK-330  
坐式手壓快沖器(二段式)  
List Price: \$ 9,300.

TANK PARTS OF THE LOW TANK ONE PIECE TOILET

低水箱單體馬桶零件

補水管

紅色調節片自下往上調節時，全排排水量由大變小。  
Red adjusters adjust the flush volume.

按 鈕 B5039-060: \$700.  
精製高壓軟管 BHP30: \$340.  
進水器 ST1012: \$780.  
落水器 B4900P-056: \$4700.  
3英吋落水器止水墊片: \$ 500.

高壓軟管

進水器止水墊片 進水器 3英吋落水器 落水器止水墊片

TANK PARTS OF THE HIGH TANK ONE PIECE TOILET

高及低水箱單體馬桶零件

補水管

半排浮桶自下往上調節時，半排排水量由大變小。  
Half flush water adjusting buoy.

紅色調節片自下往上調節時，全排排水量由大變小。  
Red adjusters adjust the flush volume.

落水器止水墊片，矽膠材質，不易變形。  
Seal pad, silica gel material distorting resistance.

按 鈕 B5039: \$700.  
精製高壓軟管 BHP30: \$340.  
進水器 ST1012: \$780.  
落水器 B4900P: \$1700.  
落水器止水墊片: \$ 400.

高壓軟管

進水器 進水器止水墊片 落水器 落水器止水墊片

TANK PARTS OF THE TWO PIECE TOILET

分體馬桶水箱零件

補水管

半排浮桶自下往上調節時，半排排水量由大變小。  
Half flush water adjusting buoy.

紅色調節片自下往上調節時，全排排水量由大變小。  
Red adjusters adjust the flush volume.

落水器止水墊片，矽膠材質，不易變形。  
Seal pad, silica gel material distorting resistance.

按 鈕 B5039: \$700.  
精製高壓軟管 BHP30: \$340.  
進水器 ST1012: \$780.  
落水器 B4900H: \$1500.  
落水器止水墊片: \$ 400.

高壓軟管

進水器 進水器止水墊片 落水器 落水器止水墊片

低水箱大補水型水箱零件

馬桶水箱零件系列

只適合大補水型(組裝)

可調式補水器,每次沖水均可節省200CC.

可調式補水器,每次沖水均可節省200CC.

品名: 進水器 型號: ST100AD 牌價: \$3,000.

品名: 5分靜音進水器 (含可調式補水器) 型號: ST1012 牌價: \$780.

品名: 4分靜音進水器 (含可調式補水器) 型號: ST1012-1 牌價: \$780.

品名: 5分精製高壓軟管 BHP30: \$340. (30公分) BHP45: \$480. (45公分) BHP60: \$600. (60公分)

品名: 4分精製高壓軟管 BHP30-1: \$340. (30公分) BHP45-1: \$480. (45公分) BHP60-1: \$600. (60公分)

品名: 落水器 型號: K-71001 牌價: \$1,200.

品名: 排污直管 型號: K-790 牌價: \$1,200.

品名: 排污偏心管 型號: K-790B 牌價: \$1,200.

品名: 4轉5分轉接頭 牌價: \$140.

品名: 伸縮管 型號: K-790 牌價: \$2,000.

品名: 伸縮變長管

品名: 伸縮變短管

品名: 伸縮沖水按鍵 型號: K-519 牌價: \$600.

品名: 止水蓋 型號: K-886G 牌價: \$800.

各種廠牌拍賣型水件皆適用

品名: 高用止水蓋 型號: K-556C 牌價: \$1,440.

品名: B2止水蓋 型號: K-730 牌價: \$350.

品名: 鍍鎳軟管 型號: FDE-016 牌價: \$800.

品名: 沖洗配件-白 型號: EB-C033 牌價: \$1,100.

品名: 塑膠圈落水頭 型號: G-014B 牌價: \$500.

品名: 塑膠拉桿落水頭 型號: G-015 牌價: \$720.

品名: 美規落水頭 型號: G-018 牌價: \$1,000.

品名: 美規無溢水孔落水頭 型號: G-018-1 牌價: \$1,000.

品名: 玻璃落水頭 型號: G-018A 牌價: \$1,300.

品名: 不銹鋼美規按壓落水頭 型號: SB-028 牌價: \$1,300.

品名: 高向管 型號: G-024 牌價: \$450.

品名: 鍍鎳P管 型號: G-021 牌價: \$480.

品名: 鍍鎳P管(加厚型) 型號: G-021L 牌價: \$580.

品名: 塑膠P管 型號: G-022 牌價: \$280.

品名: 塑膠S管 型號: G-023 牌價: \$400.

品名: 鋼製T管 型號: G-025 牌價: \$2,600.



型號	全組品名/拆件品名	總價
K-2267T (K-2267TN)	雙功能智能馬桶 (手動感應、腳踢可沖水)	\$168,500.
K-8267	全智能馬桶安裝底座	\$50,000.
K-6677N	全智能馬桶蓋座 (不含遙控器)	\$103,000.
KT-087	水箱零件組	\$8,000.
K-2269T-5	遙控器	\$7,500.



型號	全組品名/拆件品名	總價
K-2267TN	雙功能智能馬桶 (手動感應、腳踢可沖水)	\$132,500.
K-8267	全智能馬桶安裝底座	\$50,000.
K-6677N	全智能馬桶蓋座 (不含遙控器)	\$71,000.
KT-087	水箱零件組	\$8,000.
K-2267T-5	遙控器	\$3,500.

型號	全組品名/拆件品名	總價
K-2277T	優美全智能馬桶 (手動感應)	\$128,000.
K-8267	全智能馬桶安裝底座	\$50,000.
K-6677N	全智能馬桶蓋座 (不含遙控器)	\$68,500.
KT-087	水箱零件組	\$8,000.
K-2267T-5	遙控器	\$3,500.



型號	全組品名/拆件品名	總價
K-2275T	優美全智能馬桶 (手動感應、腳踢可沖水)	\$115,000.
K-8267	全智能馬桶安裝底座	\$50,000.
K-675T	全智能馬桶蓋座 (不含遙控器)	\$54,600.
KT-075	水箱零件組	\$8,000.
K-990-2	遙控器	\$2,400.



型號	全組品名/拆件品名	總價
K-2275AUTO	優美全智能馬桶 (自動感應沖水、腳踢可沖水)	\$155,000.
K-8267	全智能馬桶安裝底座	\$50,000.
K-675AUTO	全智能馬桶蓋座 (不含遙控器)	\$90,000.
KT-075	水箱零件組	\$8,000.
K-079T	遙控器	\$7,000.

型號	全組品名/拆件品名	總價
K-2279AI	優美全智能馬桶 (自動感應沖水、腳踢可沖水)	\$288,000.
K-8267	全智能馬桶安裝底座	\$50,000.
K-679AI	全智能馬桶蓋座 (不含遙控器)	\$223,000.
KT-075	水箱零件組	\$8,000.
K-079T	遙控器	\$7,000.



型號	全組品名/拆件品名	總價
K-2481U	月牙形單體馬桶	\$35,800.
K-8481	單體馬桶瓷蓋	\$27,400.
K-660U	單體馬桶蓋座(緩降)	\$5,000.
K-081	水箱零件組	\$3,400.



型號	全組品名/拆件品名	總價
K-2593	荷花單體馬桶	\$36,800.
K-8528	單體馬桶瓷蓋	\$32,200.
K-528	馬桶蓋(緩降)	\$3,200.
K-028	水箱零件組	\$3,400.



型號	全組品名/拆件品名	總價
K-2581	卷邊單體馬桶	\$37,000.
K-2581U	懸邊單體馬桶 (原裝馬桶蓋)	\$40,000.
K-8581	單體馬桶瓷蓋	\$30,200.
K-581	馬桶蓋(緩降)	\$3,200.
K-581U	懸邊灰復馬桶蓋(緩降)	\$5,200.
K-081	水箱零件組	\$3,600.



型號	全組品名/拆件品名	總價
K-2571	傑米單體馬桶	\$26,800.
K-8571	單體馬桶瓷蓋	\$19,600.
K-571	馬桶蓋(緩降)	\$2,800.
K-071	水箱零件組	\$3,400.



型號	全組品名/拆件品名	總價
K-2599	卷邊單體馬桶	\$38,800.
K-8599	單體馬桶瓷蓋	\$33,200.
K-599	馬桶蓋(緩降)	\$3,200.
K-093	水箱零件組	\$3,400.



型號	全組品名/拆件品名	總價
K-2399	歐雅單體馬桶	\$38,800.
K-8399	單體馬桶瓷蓋	\$32,200.
K-599	馬桶蓋(緩降)	\$3,200.
K-099	水箱零件組	\$3,400.



型號	全組品名/拆件品名	總價
K-2596M	潔雅單體馬桶	\$28,000.
K-8596M	單體馬桶瓷蓋	\$21,400.
K-586	馬桶蓋(緩降)	\$3,200.
K-093	水箱零件組	\$3,400.



型號	全組品名/拆件品名	總價
K-2580M	潔雅單體馬桶	\$28,000.
K-8580M	單體馬桶瓷蓋	\$21,400.
K-580	馬桶蓋(緩降)	\$3,200.
K-093	水箱零件組	\$3,400.



型號	全組品名/拆件品名	總價
K-2896	潔雅分體馬桶	\$18,800.
K-8896	底座	\$10,000.
K-2006	水箱	\$3,200.
K-658	馬桶蓋(緩降)	\$3,200.
K-008	水箱零件組	\$2,400.



型號	全組品名/拆件品名	總價
K-2880	潔雅分體馬桶	\$18,800.
K-8888	底座	\$10,000.
K-2080	水箱	\$3,200.
K-658	馬桶蓋(緩降)	\$3,200.
K-008	水箱零件組	\$2,400.



型號	全組品名/拆件品名	總價
K-2996	潔雅分體馬桶	\$11,800.
K-8996	底座	\$4,200.
K-2006	水箱	\$3,200.
K-658	馬桶蓋(緩降)	\$2,000.
K-008	水箱零件組	\$2,400.



型號	全組品名/拆件品名	總價
K-2980	潔雅分體馬桶	\$11,800.
K-8996	底座	\$4,200.
K-2080	水箱	\$3,200.
K-658	馬桶蓋(緩降)	\$2,000.
K-008	水箱零件組	\$2,400.



型號	全組品名/拆件品名	總價
K-8896F-DK-331	快沖馬桶	\$22,100.
K-8896F	底座	\$12,000.
K-658	馬桶蓋(不上蓋)	\$2,000.
DK-331	快沖器	\$8,100.



型號	全組品名/拆件品名	總價
K-8658F-DK-331	快沖馬桶	\$19,000.
K-8658F	底座	\$8,900.
K-658	馬桶蓋(不上蓋)	\$2,000.
DK-331	快沖器	\$8,100.



型號	全組品名/拆件品名	總價
K-2742T	優美全智能馬桶 (杜福爾)	\$115,000.
K-8267	全智能馬桶安裝底座	\$50,000.
K-675T	全智能馬桶蓋座 (不含遙控器)	\$54,600.
KT-075	水箱零件組	\$8,000.
K-990-2	遙控器	\$2,400.



型號	全組品名/拆件品名	總價
K-2742	米娜兒童馬桶	\$14,400.
K-8742	底座	\$7,000.
K-2082	水箱	\$3,200.
K-611	馬桶蓋	\$2,400.
K-779	水箱零件組	\$1,800.

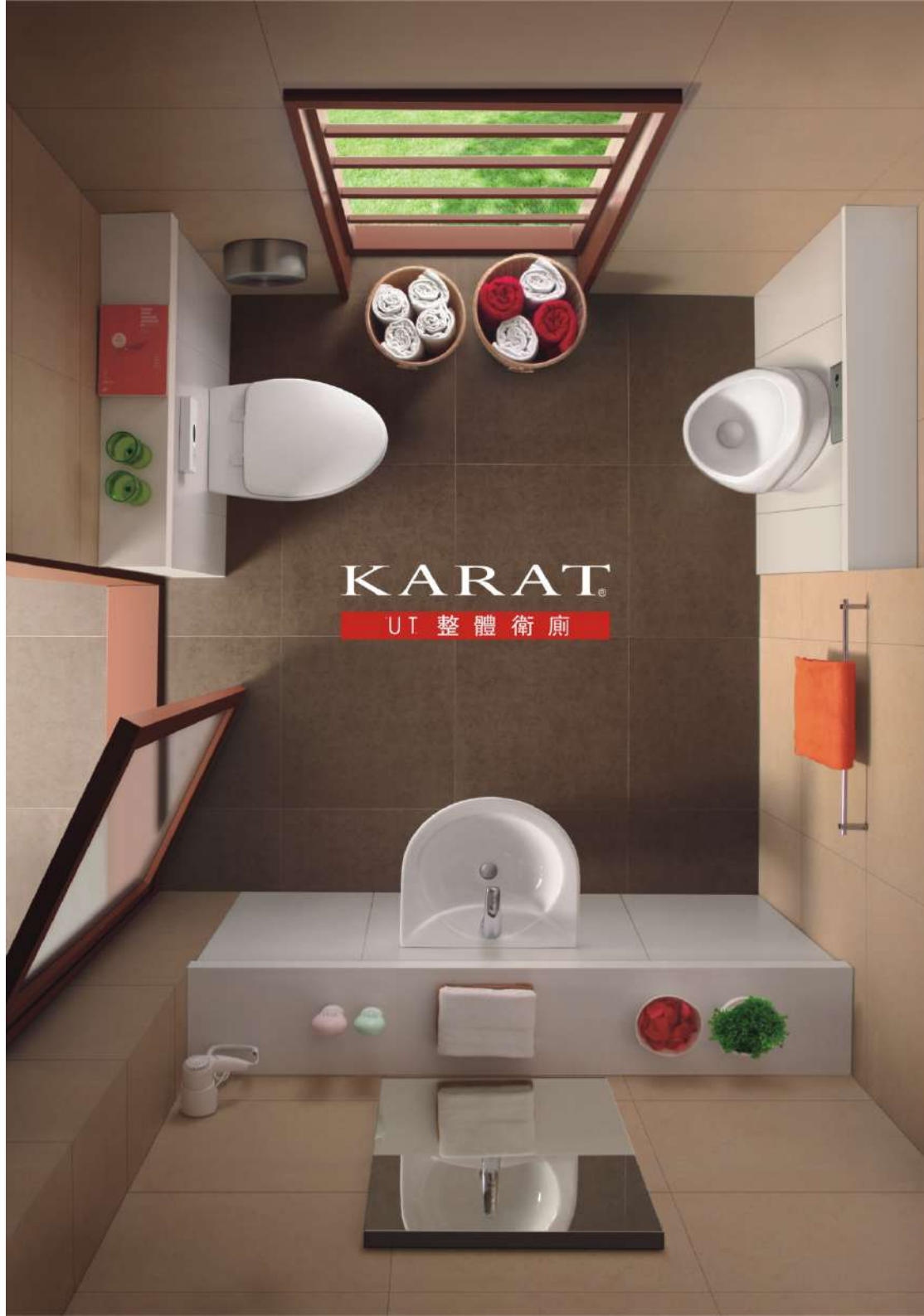

### 精心設計 | 即效施工 | 快速維修

整體衛廁採用配管單元（馬桶單元、便斗單元、面盆單元、拖布盆單元）在工廠內生產，再運至工地組裝之方式，這樣的施工流程使得工期有效的縮短且品質得以提高，賦予多樣化設計彈性，配合所算定的器具數，由KARAT替顧客做動線安排的設計，最後從製造設計上，建構一個日後保養方便且舒適美觀的衛廁場所，為您造就一個不一樣的公共衛廁空間。

UT  
Unit Toilet



臺灣地震多，公共場所易因地震而產生給排水管破裂，如使用UT系統，維修會變成快速方便，(不像傳統工法，修護時必須敲牆打磚)



櫃可訂做側櫃 (62cm除外)

