

G 章記衛廚

■ GEBERIT

2021

Citterio



Code :500.543.01.1

Price :44,000

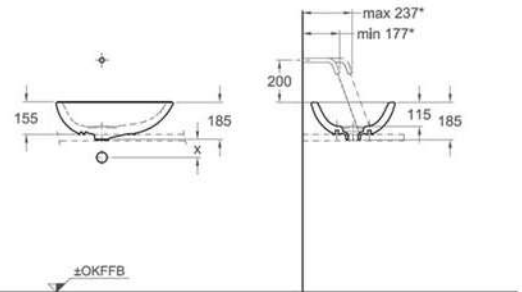
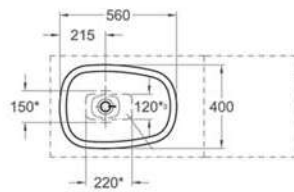

Code :500.545.01.1 (左) / 500.546.01.1 (右)

Price :43,000

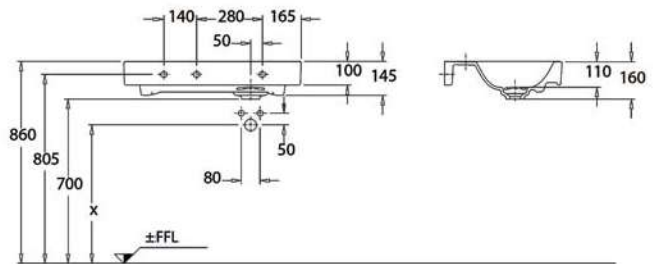
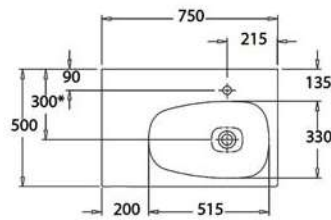

Code :500.548.01.1 (左) / 500.549.01.1 (右)

Price :64,000

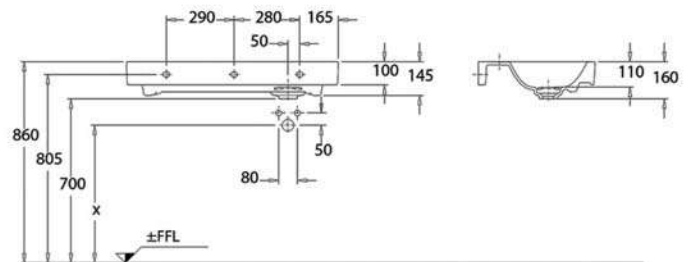
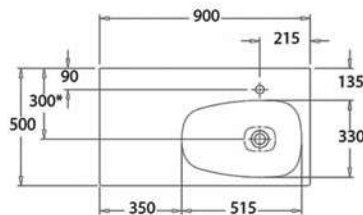

Code :500.553.01.1

Price :85,000

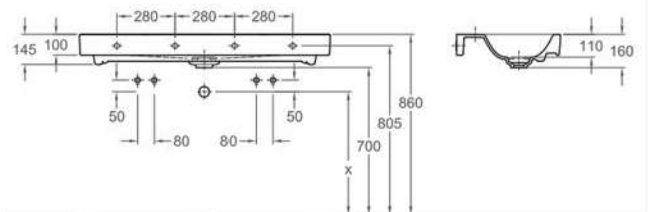
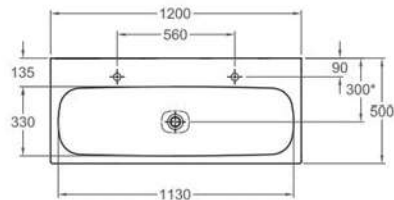

Xeno²



Code :500.528.01.1 (右) / 500.529.01.1 (左)

Price :20,000

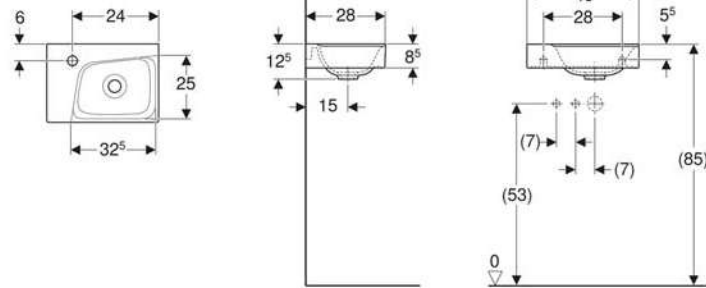

Code :500.533.01.1 (左) / 500.535.01.1 (右)

Price :58,000

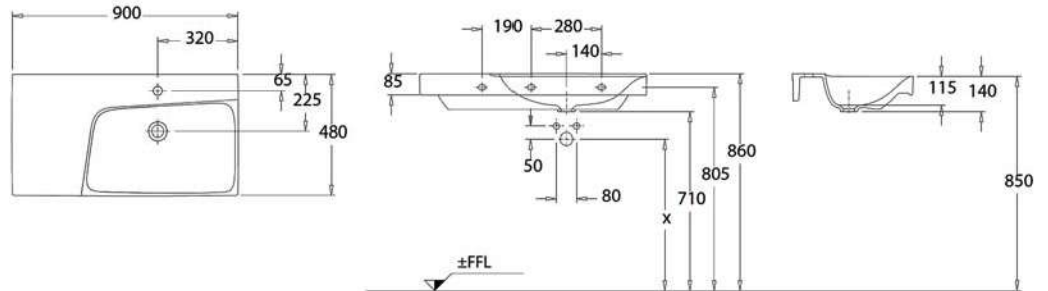

Code :500.531.01.1

Price :53,000

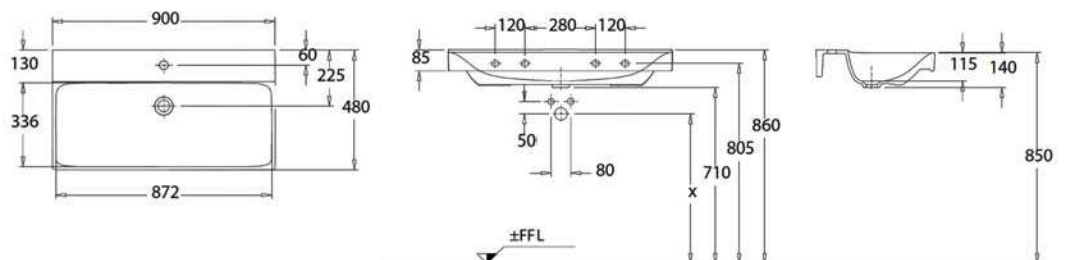



Code :500.550.01.1

Price :80,000

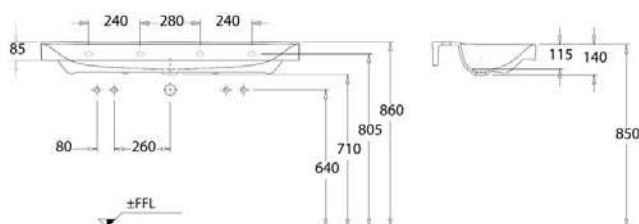
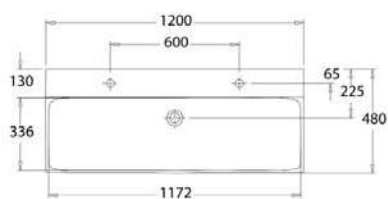

myDay



Code :125440600(右) / 125540600 (左)

Price 20,000

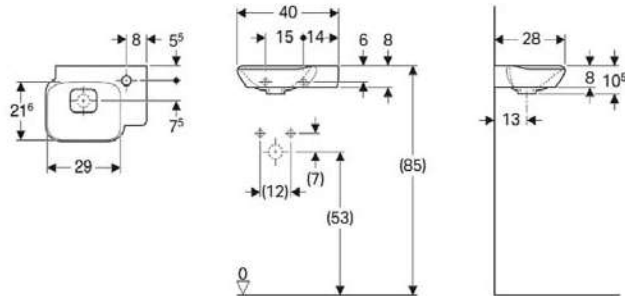

Code :125480600

Price :38,000

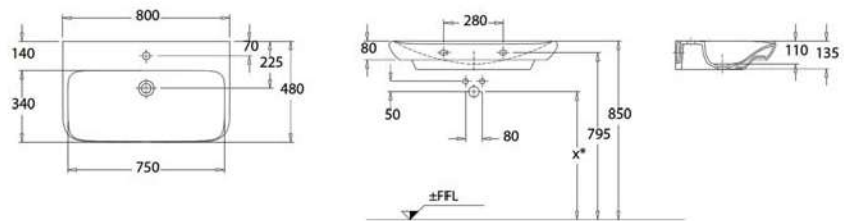

Code :135430600

Price :85,000

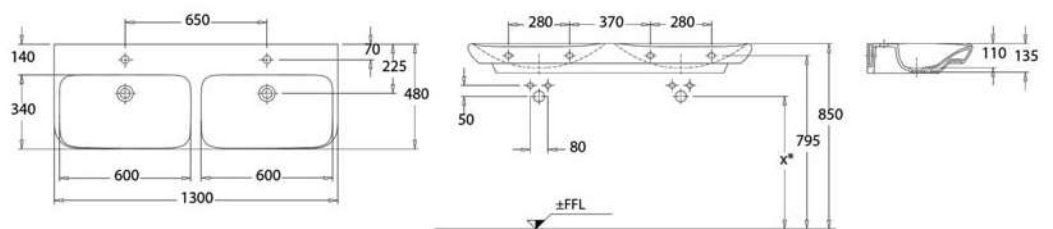



Acanto



Code :500.630.01.2

Price :43,000

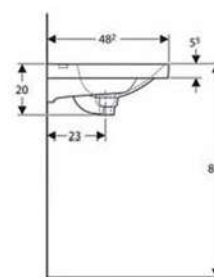
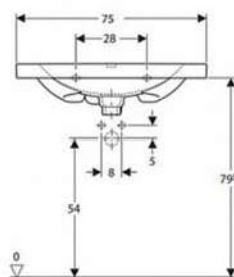
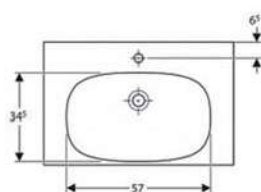

Code :500.623.01.2

Price :55,000

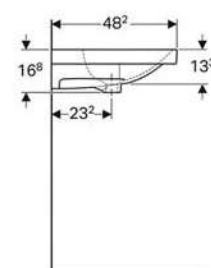
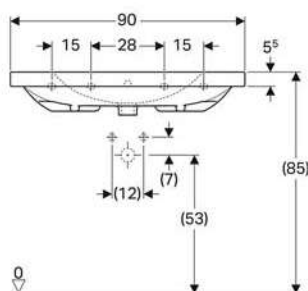
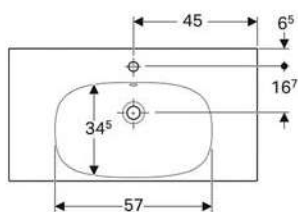



Icon



Code :124729000

Price :14,500

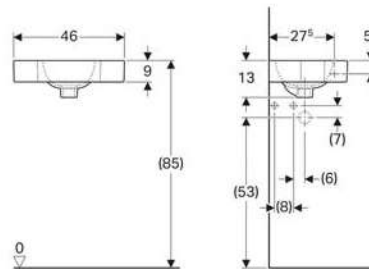
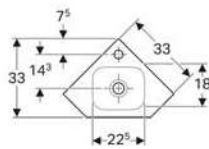

Code :124053000 (左) / 124153000 (右)

Price :23,000

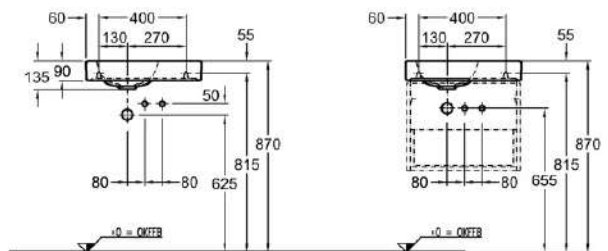
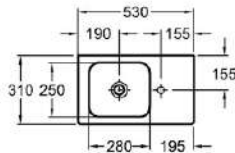

Code :124050000 (左) / 124150000 (右)

Price :25,000

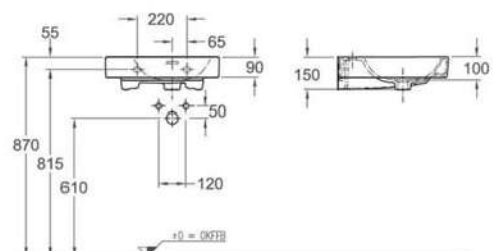
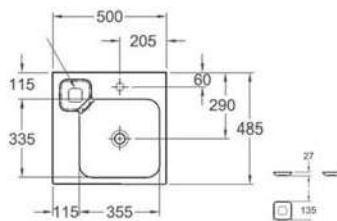

Code :124060000(有龍頭孔) / 124063000(無龍頭孔)

Price :24,000 / 26,000

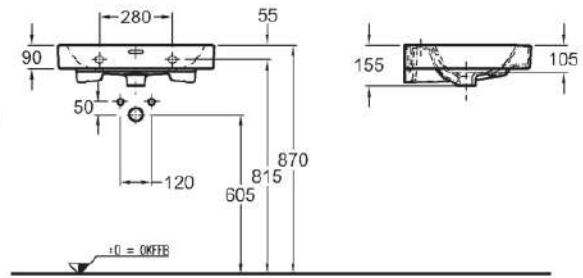
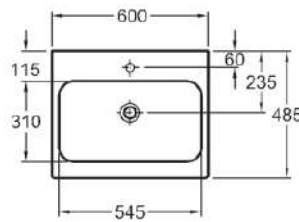

Code :124075000

Price :33,000

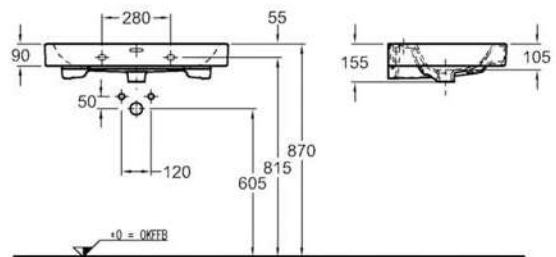
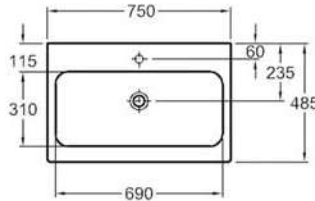

Code :124190000 (左) / 124195000 (右)

Price :53,000

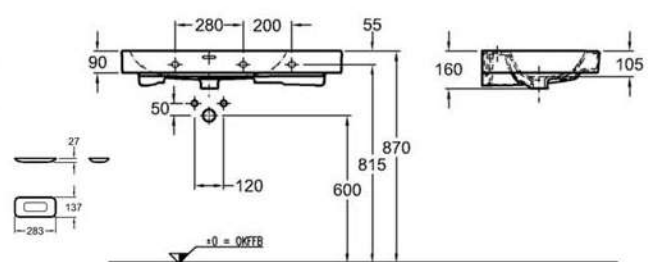
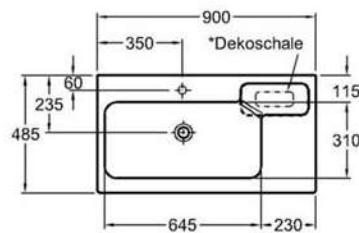

Smyle



Code :500.222.01.1

Price :15,000

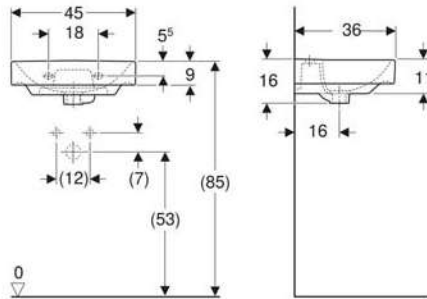
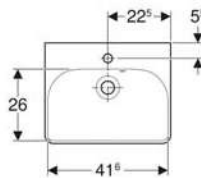

Code :500.229.01.1

Price :18,000

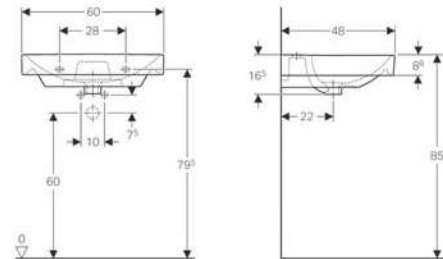
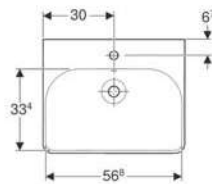

Code :500.249.01.1

Price :27,000

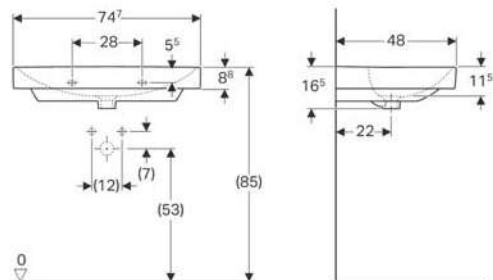
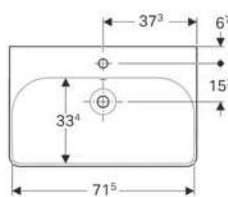



Code :500.251.01.1(有龍頭孔) / 500.250.01.1(無龍頭孔)

Price :32,000 / 36,000

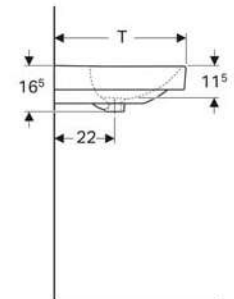
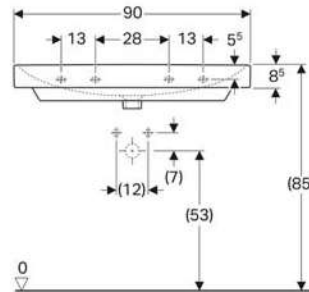
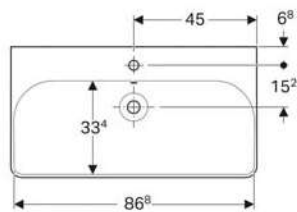

Code :500.253.01.1(單槽雙孔) / 500.226.01.1(單槽單孔) / 500.225.01.1(單槽無孔)

Price :55,000 / 55,000 / 55,000

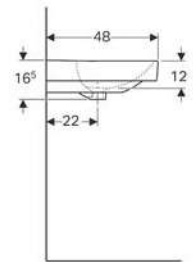
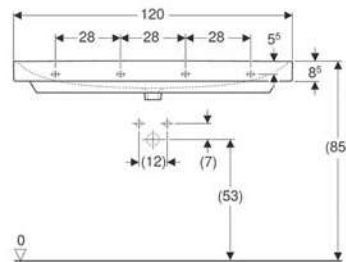
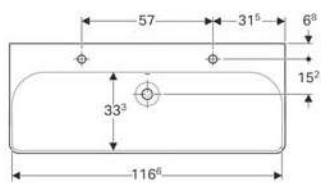

Code :500.223.01.1

Price :60,000

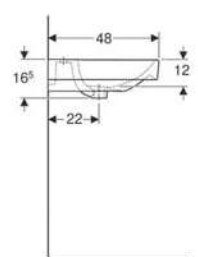
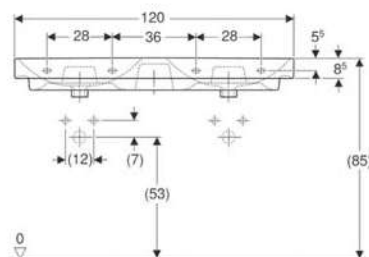
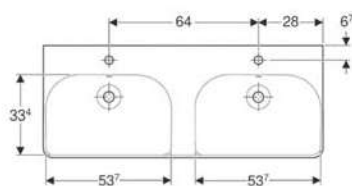

Plan



Code :276140000(左) / 276240000(右)

Price :12,000

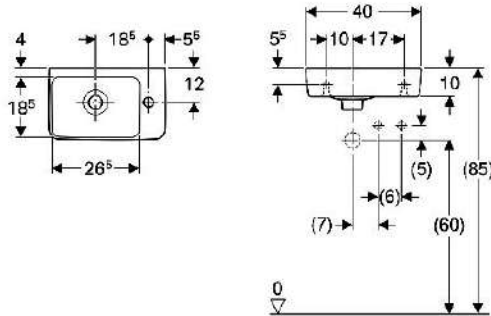

Code :276250000(左) / 276350000(右)

Price :12,500

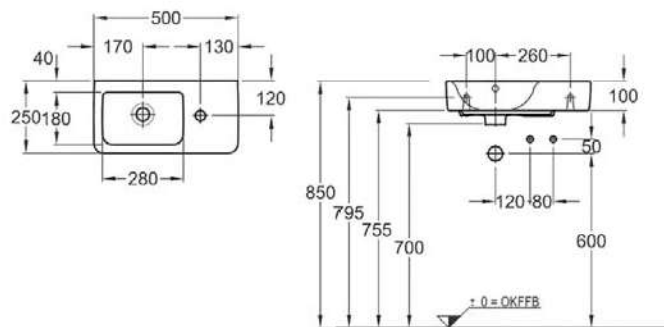

Code :226155000

Price :14,500

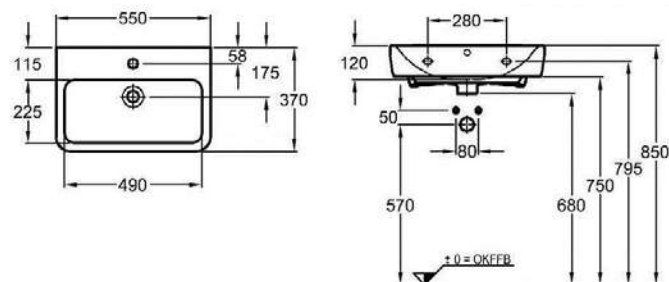



Code :225155000

Price :12,500

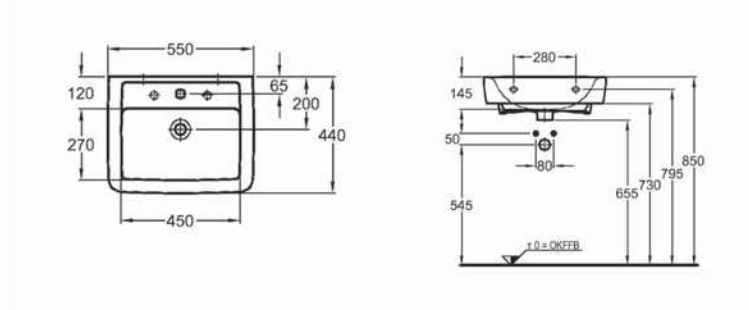

Code :225160000

Price :13,000

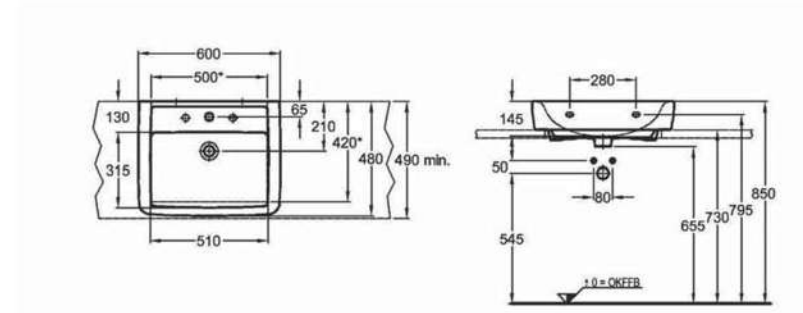

Code :225165000

Price :14,000

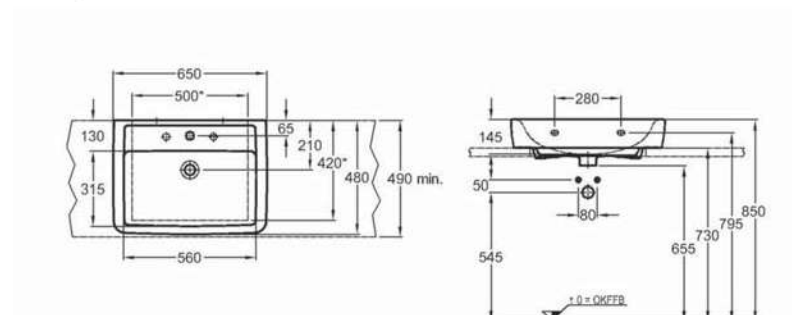

Code :122175000 (右) / 122180000 (左)

Price :25,000

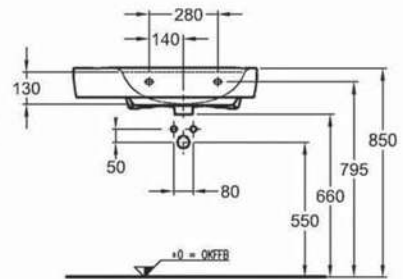
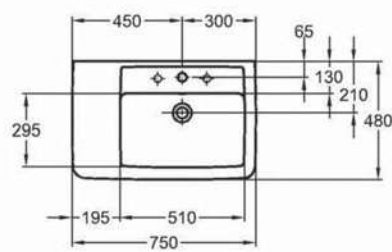

Code :125185000

Price :30,000

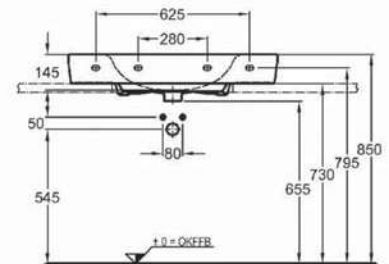
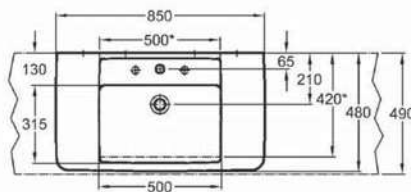

Code :125100000

Price :40,000

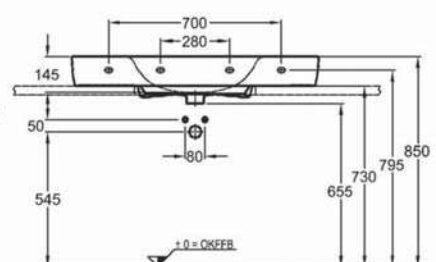
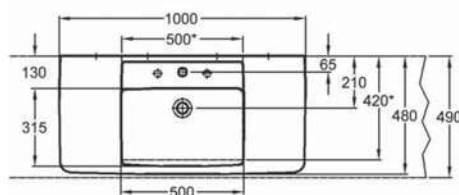

Selnova



Code :500.310.01.1

Price :9,000

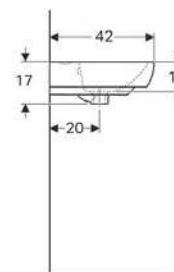
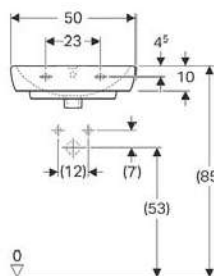
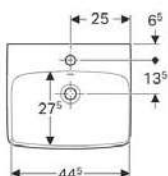

Code :500.290.01.1

Price :9,500

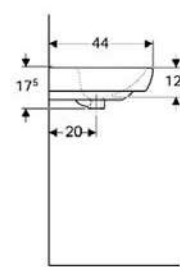
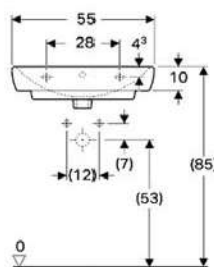
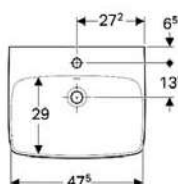

Code :500.300.01

Price :10,000

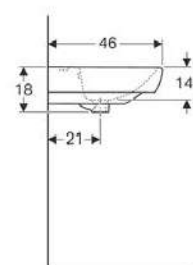
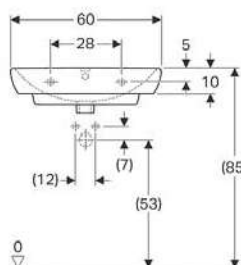
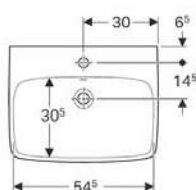

VariForm



Code :500.737.01.2

Price :16,000

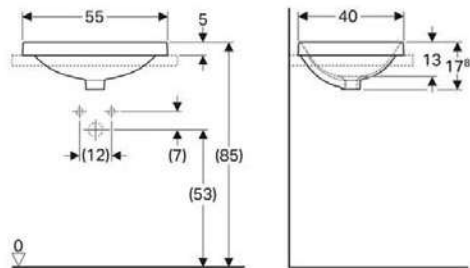
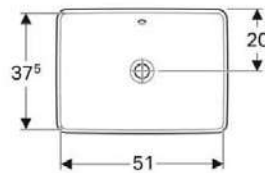

Code :500.729.01.2

Price :16,000

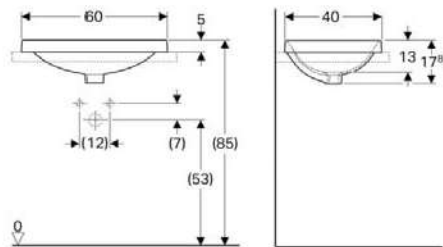
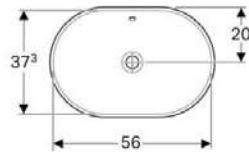

VariForm



Code :500.737.01.2

Price :16,000

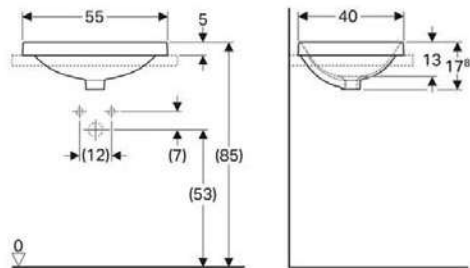
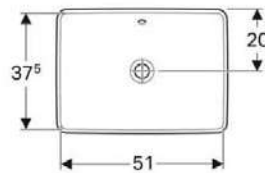

Code :500.729.01.2

Price :16,000

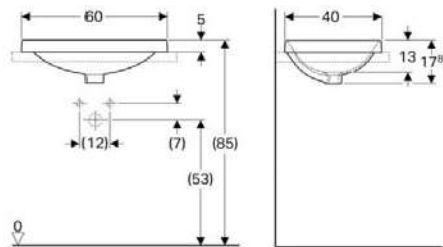
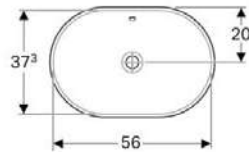



Code :500.741.01.2

Price :16,000

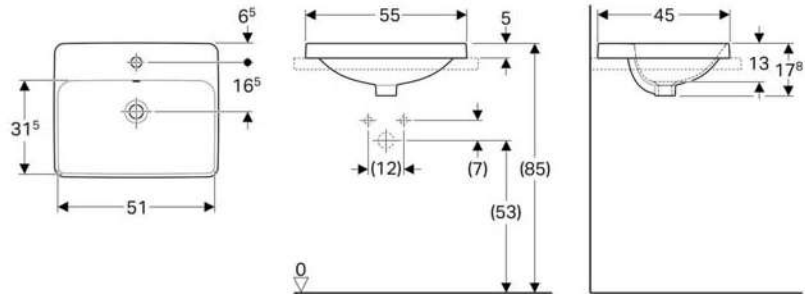

Code :500.681.01.1

Price :23,000

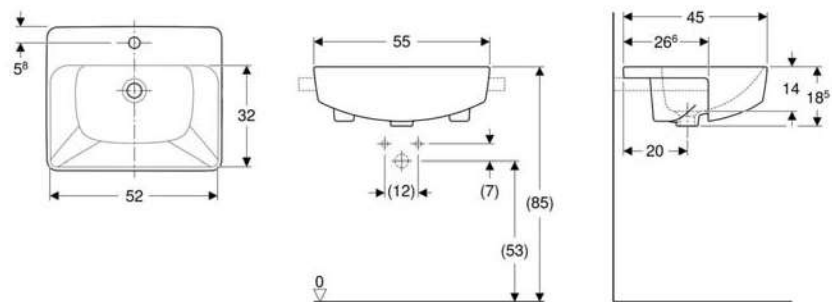

Code :117.003.00.1

Price :11,000

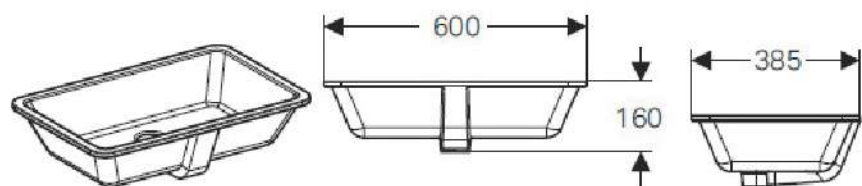



Urinal



Code :116.072.00.1

Price 96,000

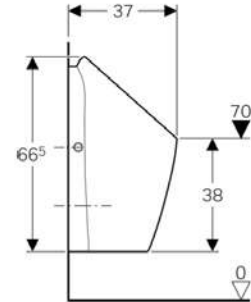
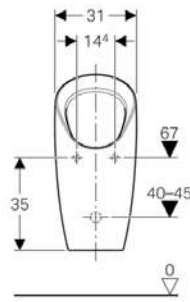



Code :235120000 (含冲水零件)

Price :44,000

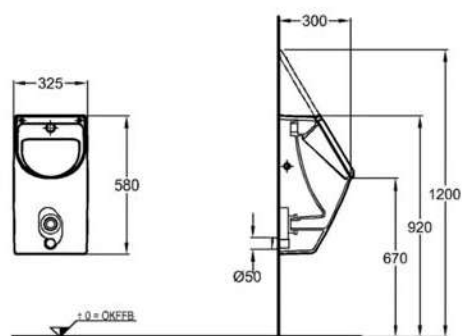

Code :117.009.00.1

Price :25,000

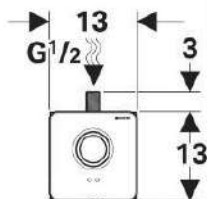

Toilet



Code :210035

Price :34,900

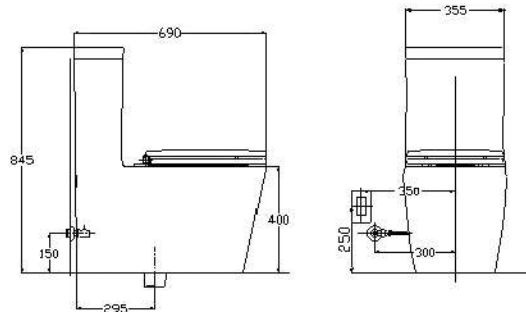

Code :171.001.01.1

Price :34,900

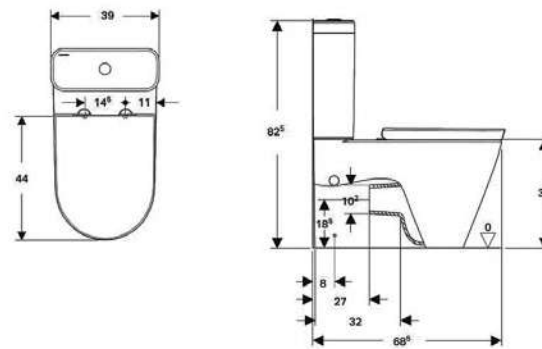



Code :222.280.00.1

Price :3,000

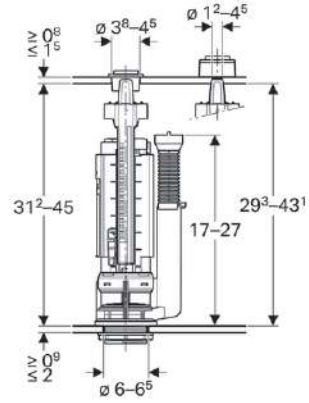

Code :271.269.00.1

Price :2,500

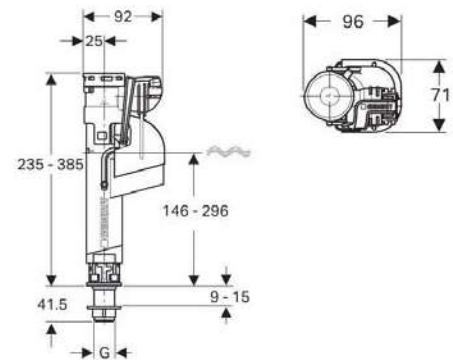

Code :152.018.00.1

Price :6,500

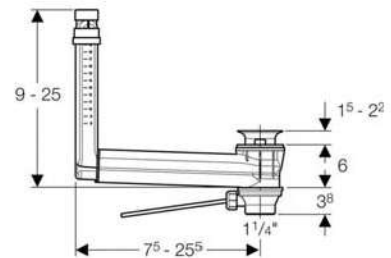

Code :151.117.11.1

Price :3,500

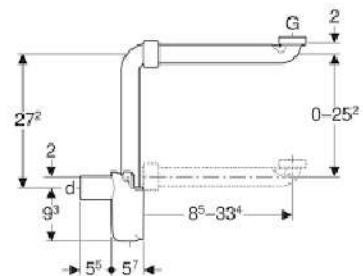

Toilet



Code :204060000 / 57413000

Price :39,000

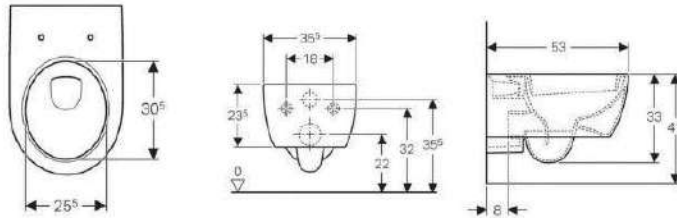

Code :110.350.00.5

Price :17,500

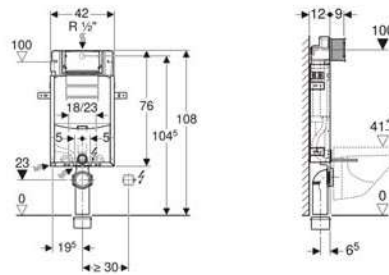

Code :224.212.00.1

Price :23,500

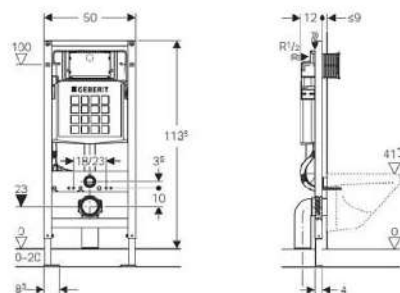
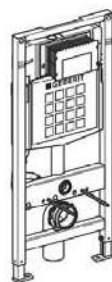



Code :110.175.00.1

Price :16,000

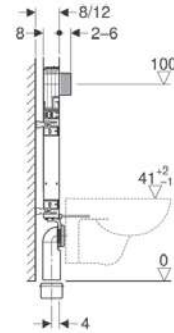
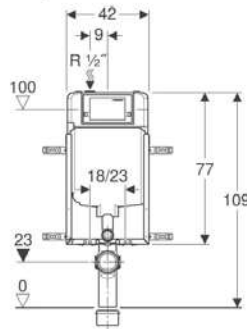

Code :115.045.46.1(霧銀)

Price :3,000

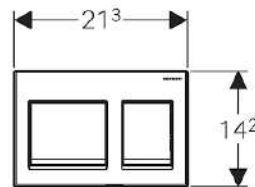

Code :115.770.21.5(亮銀) / 115.770.46.5(霧銀) / 115.770.DW.5(黑)

Price :7,500

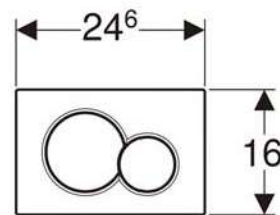
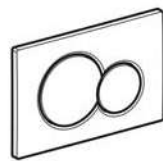

Code :115.788.DW.5 (黑玻) / 115.788.GH.5 (拉絲銀)

Price :18,000 / 25,000

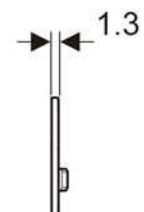
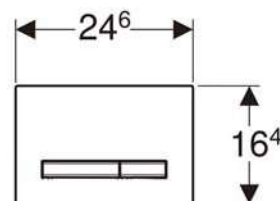
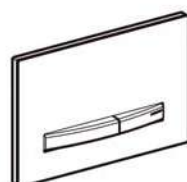

■ GEBERIT



總門市：章記衛廚
高雄市前金區中華三路166號
07-2868111
客服LINE ID：@154mavis



台南生活館：永昕衛廚
台南市南區健康路二段213號
06-2635899
客服LINE ID：@lys9118v



夢時代.B2：章記衛廚
高雄市前鎮區中華五路789號
07-8416540
客服LINE ID：@893kindg