



CONTENTS – 衛浴不鏽鋼系列產品

DAY & DAY 品牌介紹	01
安裝前注意事項	02
新品 精緻霧黑	
304 不鏽鋼 毛巾置衣架、單 / 雙毛巾掛桿組、手機座架、單掛衣勾	03
304 不鏽鋼 置物架	04
新品 絲光系列	
單 / 雙桿毛巾掛桿組、手機座架、扶手	05
毛巾置衣架、雙層轉角架	06
心 / 扇形 / 轉角 / 方形置物架	07
掛衣勾、吹風機架	08
牙刷杯架、香皂盤架、馬桶刷架、浴巾環	09
上櫃固定座、掛桿固定座、掛桿	11
掛勾、掛架固定座	12
不鏽鋼鏡面拋光毛巾桿 Towel bar	
STH2600 系列、STH2700 系列、STH6100 單桿 / 雙桿 系列	13
單層轉角架、單層方形、ST3268 系列置物架	14
毛巾置衣架 Towel & Clothes rack	15-16
單層、雙層、三層轉角架 / 單層、雙層、三層方形架、面紙架	17-20
衛浴配件 Bath accessories	21-24
旋轉直立架 Swivel stand 雙層、三層旋轉直立架	25-26
LED 鏡、易潔鏡、防霧鏡	27-28
3500 銅 平台固定座系列	29
新品 STH3700	
304 不鏽鋼鏡面拋光 – 平台固定座系列	30

- 產品規格及品項價格若有調整，以實際商品為準，恕不另行通知。
- 本目錄之產品售價自 2023 年 2 月 1 日起為準。

CONTENTS – 廚房不鏽鋼系列產品

刀柄 & 砧板架 Knife, carving board holder	31
調味罐架 & 砧板架 Spice, carving board holder	32-35
紙巾架、隔熱墊 Paper towerrack、Hot mat	35
鍋蓋架 Lid rack	36
碗盤架 Bowl & Dishes holder	37-38
桌上型碗盤架 Tableware bowl & Dishes holder	39
滴水簾、水槽碗盤籃 Rollable dishes holder & Sink basket rack	40
餐具桶、杯架 Silver ware holder、Cup stand	41-42
餐具架、小型置物架 Spoon holder、Small rack	43
高腳杯架、餐具 Goblet, Hanging rack, Tableware holder	44
感應垃圾桶 Auto sensitive dustbin	45
腳踏式垃圾桶 Dustbin	46
AWA 品牌介紹	47-48
AWA 檯面龍頭 AWA faucet	49-52
AWA 浴室感應式龍頭 AWA auto faucet	53
AWA 浴室龍頭 AWA faucet	54-55
AWA 龍頭 配件介紹 AWA accessories	56
新品 精緻霧黑	
龍頭	57-58
龍頭 Faucet	59-64
水槽 Dish Sink	65-66
環保防蟻防臭新型專利不鏽鋼後置型提籠產品特色說明	67
龍頭配件 Faucet accessories	68
經典絕版品	69-76



關於我們

營造現代舒適的生活空間，必定伴隨著良好的收納設計。DAY&DAY日日家居生活精品自1989年創立以來，以扮演優質生活的幕後推手為理念，致力於開發各式功能的掛架及收納置物架。DAY&DAY以人性為設計的價值，以機能性、高品質、及簡潔美感為設計理念，設計製造出貼近使用者的不鏽鋼生活用品。

DAY & DAY家居生活精品，配合國人各種生活需求的收納功能設計，並採用高品質304(18-8)不鏽鋼，加上頂級電鍍表面處理，針對潮濕的廚房、浴室環境，達到最高的防鏽抗腐蝕的效果，是最衛生且容易保養清理的廚衛必需品，簡潔設計能完美搭配各種的室內居家風格，創造出便利舒適的生活環境！

材質說明

不鏽鋼指的是以重量計，鉻含量超過11.5%的鐵合金。這個名稱源於這類的鋼材，不像普通鋼那樣容易腐蝕生鏽。而不鏽鋼也俗稱白鐵，擁有優良的耐酸、耐熱、耐蝕性，且表面不需再經處理，性質較碳鋼佳。常使用於廚房餐具、醫療衛生器材、食品加工用材。

304不鏽鋼即為此類，其標準成分是18%鉻加8%鎳，即一般所稱的18-8不鏽鋼。此類不鏽鋼的特性為無磁性，於加工過程中會出現弱磁性，無法藉由熱處理方法來改變其金相組織結構、加工性佳，又因含合金元素—鎳，所以抗蝕性較優。



安裝前注意事項

- 施工鑽頭為配合白色壁虎，請使用直徑 6.5~7mm 為宜。
- 不同類型的廚房掛架產品，及衛浴產品，考量不同的使用情況及承載，均有專用的螺絲(配件包)類型及長度，請勿混用。
- 產品表面應避免使用或接觸到強酸性清潔劑(如鹽酸、磁磚清潔劑)，會導至電鍍表面受損。
- **壁面產品固定墊片安裝說明**

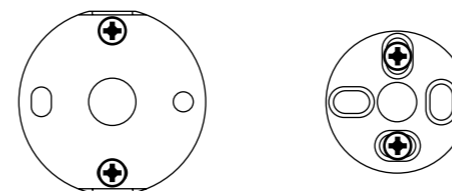

螺絲固定以上下兩點墊片承載力最佳

- **掛架固定座 (5000C-2、5000SC-2、5000LC-2) 安裝說明**
單面貼壁掛架商品，固定座宜採該商品吊掛處兩端最外側，同時於將來欲清潔時掛架仍可直接提起取下位置。

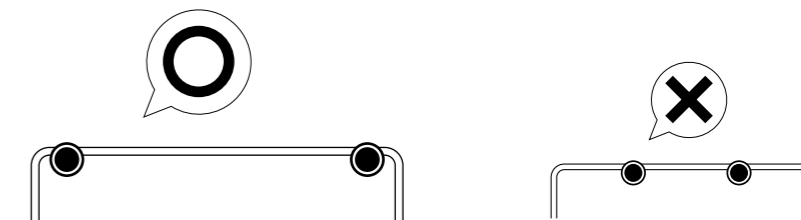

轉角式兩面貼壁掛架商品，固定座應選任單一邊吊掛處兩端最外側，同時於將來欲清潔時掛架仍可直接提起取下位置，應避免兩面各裝一顆方式。

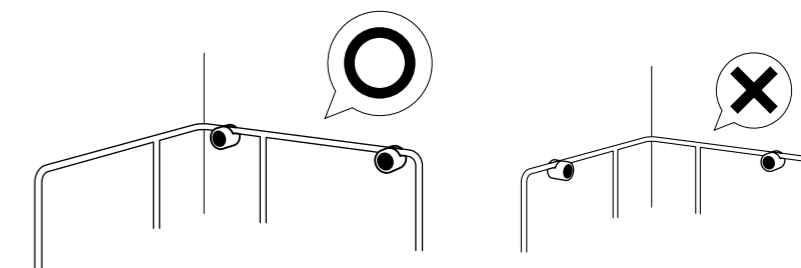

商品特色

- MIT台灣設計製造精品
- 高品質304不鏽鋼材質
- 頂級鍍鉻表面防護處理
- 最佳收納功能產品設計
- 品項齊全滿足多元需求



如何保養不鏽鋼

定時保養請以溫水或稀釋之軟性清潔劑配合海綿清洗，即可輕易去除污垢，如因水中含鐵礦物質造成的表面鏽斑再以檸檬水輕拭表面，可永保亮麗如新。

亦可搭配本公司代理進口之義大利 RGITAL 純天然植物配方之環保金屬清潔劑，安全無毒，保養效果更佳，請洽詢 DAY&DAY 全台專櫃。

天然植物生態環保清潔劑，不含防腐劑，不傷玉手。含有天然萃取精油成分，除了不改變空氣品質之外，在使用的空間中，讓深呼吸是一件享受的事。



使用方式：直接噴灑於金屬物體表面，稍作停留，以水沖洗或以海綿洗淨。

UI2088 NT\$ 600

- 環保金屬清潔劑
- 含甜橙精油、薄荷精油
- 義大利原裝進口



使用方式：直接噴灑於玻璃表面，稍作停留，再以乾布或報紙擦拭。

UI2085 NT\$ 600

- 環保玻璃清潔劑
- 含甜橙精油
- 義大利原裝進口

304 不鏽鋼 精緻霧黑



NEW

C0025BK NT\$ 4900

- 毛巾置衣架組
- 304 不鏽鋼 黑色
- TOWEL & CLOTHES SHELF
- 304 STAINLESS STEEL
- W600 X D220 X H125MM



NEW

C0021BK-60 60CM NT\$ 2700
C0021BK-75 75CM NT\$ 3000

- 單桿毛巾掛桿組
- 304 不鏽鋼 黑色
- TOWEL BAR
- 304 STAINLESS STEEL
- 掛桿固定座 W55 X H55MM
- 內距深度 70MM



NEW

C0039BK NT\$ 2400

- 手機及捲筒衛生紙架
- 304 不鏽鋼 黑色
- PAPER ROLL & PHONE HOLDER
- 304 STAINLESS STEEL
- W180 X D100 X H95 MM



NEW

C0022BK-60 60CM NT\$ 3200
C0022BK-75 75CM NT\$ 3500

- 雙桿毛巾掛桿組
- 304 不鏽鋼 黑色
- TWIN TOWEL BAR
- 304 STAINLESS STEEL
- 掛桿固定座 W55 X H55MM
- 內距 50MM / 內桿至外桿距離 60MM



NEW

C0023BK NT\$ 1000

- 單掛衣勾
- 304 不鏽鋼 黑色
- SINGLE ROBE HOOK
- 304 STAINLESS STEEL
- W55 X D63 X H55 MM

304 不鏽鋼 精緻霧黑



NEW

C0062BK NT\$ 2400
 (實景詳見右下)

- 扇形轉角架
- 304 不鏽鋼 黑色
- CORNER RACK
- 304 STAINLESS STEEL
- W230 X D230 X H80MM



NEW

C0063BK NT\$ 2000

- 抽取式衛生紙架
- 304 不鏽鋼 黑色
- FACIAL TISSUE HOLDER
- 304 STAINLESS STEEL
- W261 X D152 X H60MM



NEW

C0065BK NT\$ 2200

- 置物架
- 304 不鏽鋼 黑色
- MULTI-PURPOSE RACK
- 304 STAINLESS STEEL
- W242 X D133 X H68 MM



304 不鏽鋼 絲光系列



ST1360	60CM	NT\$ 1800
ST1375	75CM	NT\$ 1950
ST1390	90CM	NT\$ 2100

- 絲光 單桿毛巾掛桿組 5 分管
- 304 不鏽鋼 絲光固定座
- 304 不鏽鋼 絲光掛桿
- TOWEL BAR
- 304 STAINLESS STEEL
- 掛桿固定座 Ø54 X H79 (內距 58MM)



STA0051-60	60CM	NT\$ 1900
STA0051-75	75CM	NT\$ 2100
STA0051-90	90CM	NT\$ 2400

- 絲光 單桿毛巾掛桿組
- 304 不鏽鋼 絲光
- TOWEL BAR
- 304 STAINLESS STEEL
- 掛桿固定座 W38 X D70 X H20MM (內距深度 65MM)



STA0039	NT\$ 1500
----------------	-----------

- 絲光 手機及捲筒衛生紙架
- 304 不鏽鋼 絲光
- PAPER ROLL & PHONE HOLDER
- 304 STAINLESS STEEL
- W180 X D100 X H95MM



ST1560	60CM	NT\$ 3150
ST1575	75CM	NT\$ 3300
ST1590	90CM	NT\$ 3500

- 絲光 雙桿毛巾掛桿組 5 分管
- 304 不鏽鋼 絲光固定座
- 304 不鏽鋼 絲光掛桿
- TWIN TOWEL BAR
- 304 STAINLESS STEEL
- 掛桿固定座 Ø54 X H79，總高 145MM
- 低桿內距 127MM，高桿內距 60MM



STA0052-60	60CM	NT\$ 2400
STA0052-75	75CM	NT\$ 2600
STA0052-90	90CM	NT\$ 2900

- 絲光 雙桿毛巾掛桿組
- 304 不鏽鋼 絲光
- TWIN TOWEL BAR
- 304 STAINLESS STEEL
- 掛桿固定座 W38 X D115 X H20MM
- 內距 44MM / 內桿至外桿距離 54MM



ST1630	30CM	NT\$ 1600
ST1640	40CM	NT\$ 1750
ST1650	50CM	NT\$ 1900
ST1660	60CM	NT\$ 2050

- 絲光 扶手
- 304 不鏽鋼 絲光
- GRAB BAR
- 304 STAINLESS STEEL

304 不鏽鋼 絲光系列



ST1300	NT\$ 4100
---------------	-----------

- 絲光 毛巾置衣架
- 304 不鏽鋼 絲光
- TOWEL & CLOTHES SHELF
- 304 STAINLESS STEEL
- W603 X D243 X H150MM



STA0053	NT\$ 4100
----------------	-----------

- 絲光 毛巾置衣架
- 304 不鏽鋼 絲光
- TOWEL & CLOTHES SHELF
- 304 STAINLESS STEEL
- W600 X D220 X H116MM



STA0055	NT\$ 2100
----------------	-----------

- 絲光 置衣架
- 304 不鏽鋼 絲光
- CLOTHES SHELF
- 304 STAINLESS STEEL
- W650 X D220 X H50MM



NEW

ST1300S	NT\$ 3850
----------------	-----------

- 絲光 毛巾置衣架
- 304 不鏽鋼 絲光
- TOWEL & CLOTHES SHELF
- 304 STAINLESS STEEL
- W450 X D243 X H150MM



STA0056	NT\$ 2800
----------------	-----------

- 絲光 毛巾置衣架
- 304 不鏽鋼 絲光
- TOWEL & CLOTHES SHELF
- 304 STAINLESS STEEL
- W650 X D220 X H120MM



NEW

STA0066-2	NT\$ 3800
------------------	-----------

- 絲光 雙層轉角架
- 304 不鏽鋼 絲光
- CORNER RACK DOUBLE
- 304 STAINLESS STEEL
- W215 X D215 X H415MM
- 內徑高度 315MM

304 不鏽鋼 絲光系列



NEW

STA0061 NT\$ 2000

- 絲光 心形置物架
- 304 不鏽鋼 絲光
- HEART CORNER RACK
- 304 STAINLESS STEEL
- W250 X D250 X H85MM



NEW

STA0062 NT\$ 2000

- 絲光 扇形轉角架
- 304 不鏽鋼 絲光
- CORNER RACK
- 304 STAINLESS STEEL
- W230 X D230 X H80MM



NEW

STA0063 NT\$ 1500

- 絲光 抽取式衛生紙架
- 304 不鏽鋼 絲光
- FACIAL TISSUE HOLDER
- 304 STAINLESS STEEL
- W261 X D152 X H60MM



NEW

STA0065 NT\$ 1800

- 絲光 置物架
- 304 不鏽鋼 絲光
- MULTI-PURPOSE RACK
- 304 STAINLESS STEEL
- W242 X D132 X H68MM

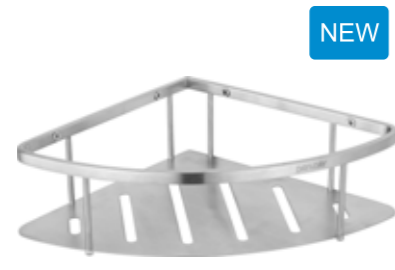

NEW

ST1021 NT\$ 2900

- 絲光 轉角架
- 304 不鏽鋼 絲光
- CORNER RACK
- 304 STAINLESS STEEL
- W226 X D226 X H75MM



NEW

ST1022 NT\$ 2700

- 絲光 方型置物架
- 304 不鏽鋼 絲光
- MULTI-PURPOSE RACK
- 304 STAINLESS STEEL
- W265 X D122 X H75MM

304 不鏽鋼 絲光系列



NEW

STA0037 NT\$ 700

- 絲光 單掛衣勾
- 304 不鏽鋼 絲光
- SINGLE ROBE HOOK
- 304 STAINLESS STEEL
- 固定座 Ø 28MM
- W29 X D50 X H65MM



NEW

STA0038 NT\$ 800

- 絲光 雙掛衣勾
- 304 不鏽鋼 絲光
- DOUBLE ROBE HOOK
- 304 STAINLESS STEEL
- 固定座 W38 X H20MM
- W90 X D60 X H24MM



ST1016 NT\$ 1200

- 絲光 單掛衣勾
- 304 不鏽鋼 絲光
- SINGLE ROBE HOOK
- 304 STAINLESS STEEL
- Ø 50MM
- W50 X D67 X H62MM



ST1017 NT\$ 1300

- 絲光 雙掛衣勾
- 304 不鏽鋼 絲光
- DOUBLE ROBE HOOK
- 304 STAINLESS STEEL
- Ø 50MM
- W77 X D67 X H50MM



NEW

STA0033 NT\$ 1100

- 絲光 吹風機架
- 304 不鏽鋼 絲光
- 適用負離子吹風機
- HAIR DRYER HOLDER
- W150 X D114 X H22MM
- 圓內徑 86MM



ST1019 NT\$ 1550

- 絲光 吹風機架
- 304 不鏽鋼 絲光
- HAIR DRYER HOLDER
- 304 STAINLESS STEEL
- W100 X D118 X H110MM

304 不鏽鋼 絲光系列



NEW

STA0031 NT\$ 1100

- 絲光 牙刷杯架
- 304 不鏽鋼 絲光
- 附透明玻璃杯 GLASS CUP
- CUP WITH HOLDER
- 304 STAINLESS STEEL
- W125 X D100 X H95MM



NEW

STA0032 NT\$ 1100

- 絲光 香皂盤架
- 304 不鏽鋼 絲光
- 附透明玻璃 香皂盤 GLASS SOAP
- SOAP DISH WITH HOLDER
- 304 STAINLESS STEEL
- W145 X D120 X H40MM



ST1006 NT\$ 1300

- 絲光 浴巾環
- 304 不鏽鋼 絲光
- BIGGER TOWER RING
- 304 STAINLESS STEEL
- W170 X D66 X H190MM
- 圓內徑 152MM



NEW

STA0035 NT\$ 1500

- 絲光 馬桶刷架
- 304 不鏽鋼 絲光
- 附馬桶刷 & 霧面玻璃杯
- TOILET BRUSH & GLASS CUP WITH HOLDER
- 304 STAINLESS STEEL
- W159 X D125 X H345MM
- 圓內徑 86MM



NEW

STA0036 NT\$ 150

- 絲光 馬桶刷
- 304 不鏽鋼 絲光
- TOILET BRUSH
- 304 STAINLESS STEEL
- W335MM



NEW

1023 NT\$ 130

- 透明玻璃 牙刷杯
- TOOTH-BRUSH CUP
- GLASS
- Ø70 X H95MM



NEW

1024 NT\$ 180

- 透明玻璃 香皂盤
- SOAP DISH
- GLASS
- Ø110 X H40MM



NEW

1025 NT\$ 250

- 霧面玻璃 馬桶刷杯
- TOILET BRUSH CUP
- GLASS
- Ø115 X H112MM



DAY&DAY
Quality for everyday living

上櫃用掛桿頭

NEW



2900-2 NT\$ 900 / 一對
2900 (中通) NT\$ 450 / 一個
 (實景詳見左圖)
 • 掛桿上櫃固定座 (霧面)
 • 上櫃側板用
 • HOLDER
 • ALUMINUM 鋁
 • W17 X D90 X H75MM



2500-2 NT\$ 900 / 一對
2500 (中通) NT\$ 450 / 一個
 (實景詳見頁 44 左上)
 • 掛桿上櫃固定座 (霧面)
 • HOLDER
 • ALUMINUM 鋁
 • W25 X D62 X H70MM



ST3001-5 NT\$ 500
 • 五聯勾 附固定頭
 • W340MM
ST3001-8 NT\$ 650
 • 八聯勾 附固定頭
 • W492MM
 • HOOK RAILS
 • 304 STAINLESS STEEL



ST3001-5S NT\$ 350
 • 五聯勾
 • W335MM
ST3001-8S NT\$ 500
 • 八聯勾
 • W462MM
 • 可另選購 7000C-2 或 7200C-2 螺絲固定頭
 • HOOK RAILS
 • 304 STAINLESS STEEL



STC0103 NT\$ 760
 • 三聯掛衣勾
 • ROBE HOOK RAILS
 • 304 STAINLESS STEEL
 • W280 X D53 X H85MM



1000C-2 掛桿頭 NT\$ 500 / 一對
1000CM (中通) NT\$ 250 / 一個
 • 掛桿固定座
 • HOLDER
 • CHROME PLATING 不鏽鋼色
 • BRASS 青銅材質
 • φ 25 X D60MM



2000C-2 掛桿頭 NT\$ 940 / 一對
2000CM (中通) NT\$ 470 / 一個
 • 掛桿固定座
 • HOLDER
 • CHROME PLATING 不鏽鋼色
 • BRASS 青銅材質
 • φ 55 X D65MM



3000C-2 掛桿頭 NT\$ 500 / 一對
3000M (中通) NT\$ 250 / 一個
 • 掛桿固定座
 • HOLDER
 • CHROME PLATING 不鏽鋼色
 • ZINC DIE CAST 鋅合金
 • W30 X D60 X H66MM



4000C-2 NT\$ 240 / 一對
 • 掛架固定座
 • HOLDER
 • CHROME PLATING 不鏽鋼色
 • BRASS 青銅材質
 • φ 19 X D57MM



5000C-2 (薄底) NT\$ 150 / 一對
 • φ 20 X D21MM
5000SC-2 (厚底) NT\$ 150 / 一對
 • φ 20 X D25MM
5000LC-2 (薄底) NT\$ 270 / 一對
 • φ 29 X D27MM

• 掛架固定座
 • HOLDER
 • CHROME PLATING 不鏽鋼色
 • BRASS 青銅材質



ST3001-3 NT\$ 190
 (實景詳見頁 44)
 • 單S掛勾
 • S-HOOK SINGLE
 • 304 STAINLESS STEEL



ST3002 NT\$ 110
 (實景詳見頁 34)
 • 雙S掛勾
 • S-HOOK DOUBLE
 • 304 STAINLESS STEEL



NEW

STH2600-2 掛桿頭 NT\$ 1300 / 一對
STH2600M (中通) NT\$ 650 / 一個
 • 掛桿固定座
 • HOLDER
 • 304 STAINLESS STEEL 不鏽鋼
 • 304 不鏽鋼鏡面拋光
 • φ 25 X D62MM

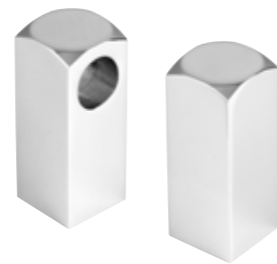

NEW

STH2700-2 掛桿頭 NT\$ 1600 / 一對
STH2700M (中通) NT\$ 800 / 一個
 (實景詳見頁 15、32)
 • 掛桿固定座
 • HOLDER
 • 304 STAINLESS STEEL 不鏽鋼
 • 304 不鏽鋼鏡面拋光
 • W23 X D62 X H23MM



2500-A NT\$ 25
 • 5分管 矽膠塞頭



ST2045 45CM NT\$ 200
ST2060 60CM NT\$ 250
ST2075 75CM NT\$ 300
ST2090 90CM NT\$ 400
ST2120 120CM NT\$ 500
ST2150 150CM NT\$ 700
ST2180 180CM NT\$ 950
 • 亮麗不鏽鋼管
 • THICKNESS 厚度 0.8~1.2MM
 • 304 STAINLESS STEEL
 • φ 16MM (5分管)



7000C-2 NT\$ 120 / 一對
 • 螺絲固定頭 螺帽青銅材質
 • 螺帽 CHROME PLATING 不鏽鋼色
 • φ 13 X D12MM
 • 適用品項
 ST3001-5S, ST3001-8S
 ST3267, ST6632



7200C-2 NT\$ 190 / 一對
 • 螺絲固定頭 螺帽青銅材質
 • 螺帽 CHROME PLATING 不鏽鋼色
 • 適用品項
 ST3001-5S ST3001-8S
 ST3205 ST3205T ST3208
 ST3208A ST3208A-2 ST3209
 ST3209-2 ST3267
 ST5230A ST6632
 ST3266 ST3266-01



ST3036 NT\$ 250
 • 砧板掛勾
 • CARVING BOARD HOOK
 • 304 STAINLESS STEEL
 • W72 X D112 X H75MM



1000 系列 (5 分管)

1245C 不鏽鋼色 45CM	NT\$700
1260C 不鏽鋼色 60CM	NT\$750
1275C 不鏽鋼色 75CM	NT\$800
1290C 不鏽鋼色 90CM	NT\$900

- 單桿毛巾掛桿組
- 青銅掛桿固定座 +304 不鏽鋼掛桿
- TOWEL BAR
- BRASS HOLDER
- 304 STAINLESS STEEL TUBE
- 掛桿固定座 Ø25 X D60MM (內距 40MM)



2000 系列 (5 分管)

2245C 不鏽鋼色 45CM	NT\$1140
2260C 不鏽鋼色 60CM	NT\$1190
2275C 不鏽鋼色 75CM	NT\$1240
2290C 不鏽鋼色 90CM	NT\$1340

- 單桿毛巾掛桿組
- 青銅掛桿固定座 +304 不鏽鋼掛桿
- TOWEL BAR
- BRASS HOLDER
- 304 STAINLESS STEEL TUBE
- 掛桿固定座 Ø55 X D65MM (內距 40MM)



3000 系列 (5 分管)

3245C 不鏽鋼色 45CM	NT\$700
3260C 不鏽鋼色 60CM	NT\$750
3275C 不鏽鋼色 75CM	NT\$800
3290C 不鏽鋼色 90CM	NT\$900

- 單桿毛巾掛桿組
- 鋅合金固定座 +304 不鏽鋼掛桿
- TOWEL BAR
- ZIN DIE CAST HOLDER
- 304 STAINLESS STEEL TUBE
- 掛桿固定座 W30 X D60 X D66MM (內距 40MM)



ST3266-01 NT\$ 1950

- 轉角架
- CORNER RACK
- 304 STAINLESS STEEL
- W230 X D235 X H57MM



ST3266 NT\$ 2300

(實景詳見頁 19)

- 轉角架
- CORNER RACK
- 304 STAINLESS STEEL
- W230 X D235 X H95MM

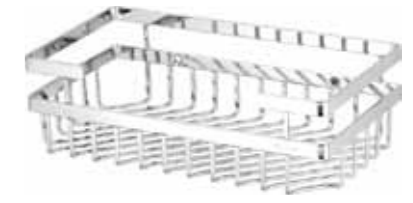

ST3267 NT\$ 2650

- 單層置物架 (扁型線條)
- 可另選購 7000C-2 或 7200C-2 螺絲固定座
- SINGLE RACK
- 304 STAINLESS STEEL
- W320 X D170 X H100MM

NEW

NEW



STH2600 系列 (5 分管)

STH2645C 45CM	NT\$1500
STH2660C 60CM	NT\$1550
STH2675C 75CM	NT\$1600
STH2690C 90CM	NT\$1700

- 單桿毛巾掛桿組
- 304 不鏽鋼鏡面拋光掛桿固定座 +304 不鏽鋼掛桿
- TOWEL BAR
- 304 STAINLESS STEEL HOLDER
- 304 STAINLESS STEEL TUBE
- 掛桿固定座 Ø25 X D62MM(內距 40MM)



STA0012-60 60CM	NT\$ 1500
STA0012-75 75CM	NT\$ 1700

- 單桿毛巾掛桿組
- 304 不鏽鋼
- TOWEL BAR
- 304 STAINLESS STEEL
- 掛桿固定座 Ø60MM (內距 62MM)

NEW



STH2700 系列 (5 分管)

STH2745 45CM	NT\$1800
STH2760 60CM	NT\$1850
STH2775 75CM	NT\$1900
STH2790 90CM	NT\$2000

- 單桿毛巾掛桿組
- 304 不鏽鋼鏡面拋光固定座 +304 不鏽鋼掛桿
- TOWEL BAR
- 304 STAINLESS STEEL HOLDER
- 304 STAINLESS STEEL HOLDER TUBE
- 掛桿固定座 Ø22 X D62MM (內距 40MM)



STH6100 不鏽鋼系列 (4 分管)

STH6160 60CM	NT\$2100
STH6175 75CM	NT\$2150
STH6190 90CM	NT\$2250

- 單桿毛巾掛桿組
- 304 不鏽鋼鏡面拋光固定座 +304 不鏽鋼掛桿
- TOWEL BAR
- HOLDER & TUBE
- 304 STAINLESS STEEL
- 掛桿固定座 Ø38 X D87MM (內距 62MM)



STH6100 不鏽鋼系列 (4 分管)

STH6160-2 60CM	NT\$2650
STH6175-2 75CM	NT\$2750
STH6190-2 90CM	NT\$2950

(實景詳見頁 16)

- 雙桿毛巾掛桿組
- 304 不鏽鋼鏡面拋光固定座 +304 不鏽鋼掛桿
- TWIN TOWEL BAR
- 304 STAINLESS STEEL HOLDER & TUBE
- 掛桿固定座 Ø38 X D114MM (內距 46MM/內桿至外桿距離 36MM)

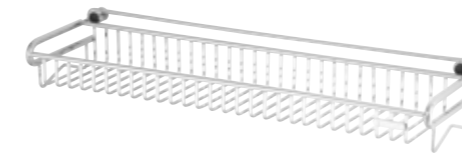

ST3268XL NT\$ 3050

- 平台置物架
- 附 5000SC-2 掛架固定座 厚底
- SINGLE MULTI-PURPOSE RACK
- 304 STAINLESS STEEL
- W600 X D160 X D90MM

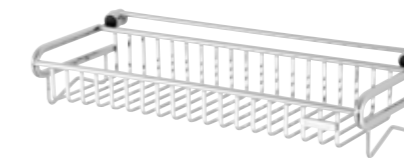

ST3268-1 NT\$ 2500

(實景詳見頁 24)

- 單層置物架(扁型線條)
- 附5000SC-2掛架固定座 厚底
- SINGLE MULTI-PURPOSE RACK
- 304 STAINLESS STEEL
- W420 X D160 X D90MM

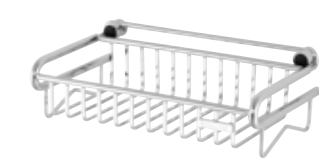

ST3268-1S NT\$ 1950

- 單層置物架-窄版(扁型線條)
- 附5000SC-2掛架固定座 厚底
- SINGLE MULTI-PURPOSE RACK
- 304 STAINLESS STEEL
- W275 X D160 X H90MM



ST3268 NT\$ 4500

- 雙層置物架(扁型線條、強化玻璃6MM)
- 附5000SC-2掛架固定座 厚底
- DOUBLE MULTI-PURPOSE RACK
- 304 STAINLESS STEEL
- W470 X D260 X H340MM
- 內徑高度 250MM



ST3268-2 NT\$ 4850

- 雙層置物架(扁型線條)
- 附5000SC-2掛架固定座 厚底
- DOUBLE MULTI-PURPOSE RACKS
- 304 STAINLESS STEEL
- W420 X D160 X D380MM
- 內徑高度 285MM



ST3268-2S NT\$ 3750

- 雙層置物架-窄版(扁型線條)
- 附5000SC-2掛架固定座 厚底
- DOUBLE MULTI-PURPOSE RACKS
- 304 STAINLESS STEEL
- W275 X D160 X H380MM
- 內徑高度 285MM



ST2298SD-02 NT\$ 4000

- 雙層毛巾及多功能架 - 單桿
- 附 5000LC-2 掛架固定座
- TOWEL SHELF & DOUBLE MULTI-PURPOSE RACK
- 304 STAINLESS STEEL
- W380 X D200 X H400MM
- 內徑高度 270MM



ST2298SH NT\$ 2850

(實景詳見頁 10)

- W460 X D260 X H65MM

ST2298LH NT\$ 3300

- W620 X D260 X H65MM

- 多功能架
- 附 5000LC-2 掛架固定座
- MULTI-PURPOSE RACK
- 304 STAINLESS STEEL



ST2298LDH NT\$ 2500

- 多功能置物架-窄版
- 附 5000LC-2 掛架固定座
- MULTI-PURPOSE RACK
- 304 STAINLESS STEEL
- W620 X D200 X H65MM

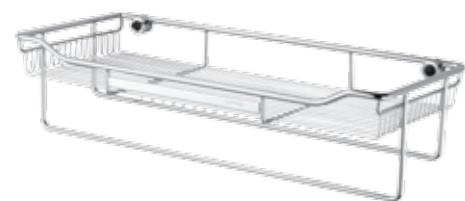

ST2298L NT\$ 4000

(實景詳見上圖)

- 毛巾及多功能架
- 附5000LC-2 掛架固定座
- TOWEL SHELF & MULTI-PURPOSE RACK
- 304 STAINLESS STEEL
- W620 X D260 X H160MM



ST2298L-2A NT\$ 4000

- 毛巾置物架-雙桿
- 附 5000SC-2 掛架固定座 厚底
- TOWEL SHELF & MULTI-PURPOSE RACK
- 304 STAINLESS STEEL
- W610 X D240 X H200MM



ST6678DP 扁條 NT\$ 5250

- 雙層置物架 (掛、放兩用)
- 附 5000C-2 掛架固定座 薄底
- DOUBLE RACK
- 304 STAINLESS STEEL
- W468 X D280 X H440MM
- 內徑高度 336MM



ST3078F NT\$ 5900

- 雙層置物架 (掛、放兩用)
- 附 3061-50 大滴水盤 X2
- 附 5000SC-2 掛架固定座 厚底
- DOUBLE MULTI-PURPOSE RACK
- 304 STAINLESS STEEL
- W575 X D245 X H460MM
- 內徑高度 303MM

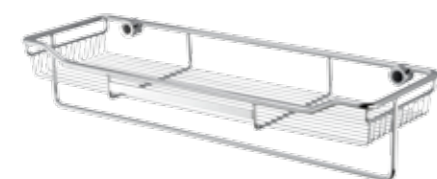

ST2298LD-1 NT\$ 3200

- 毛巾及多功能架-窄版-單桿
- 附 5000LC-2 掛架固定座
- TOWEL SHELF & MULTI-PURPOSE RACK
- 304 STAINLESS STEEL
- W620 X D200 X H127MM

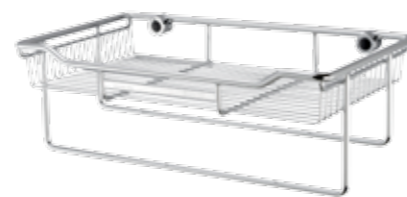

ST2298S NT\$ 3400

- 毛巾及多功能架
- 附5000LC-2 掛架固定座
- TOWEL SHELF & MULTI-PURPOSE RACK
- 304 STAINLESS STEEL
- W460 X D260 X H160MM



ST3068BS NT\$ 6800

- 雙層置物架
- DOUBLE RACK
- 304 STAINLESS STEEL
- W625 X D250 X H620MM
- 內徑高度 220MM





ST3033S-2CH NT\$ 3500
(實景詳見下圖)

- 雙層轉角架 (掛·放兩用)
- 附5000C-2掛架固定座 薄底
- CORNER RACK DOUBLE S
- 304 STAINLESS STEEL
- W230 X D235 X H420MM
- 內徑高度 320MM



ST3033S-3CH NT\$ 5100

- 三層轉角架 S (掛·放兩用)
- 附5000C-2掛架固定座 薄底
- CORNER RACK TRIPLE S
- 304 STAINLESS STEEL
- W230 X D235 X H680MM
- 內徑高度上層 240MM
- 內徑高度下層 320MM



ST2296S-2H NT\$ 3400
(實景詳見右圖)

- 雙層架 (掛·放兩用)
- 附5000SC-2掛架固定座 厚底
- DOUBLE RACK S
- 304 STAINLESS STEEL
- W280 X D150 X H440MM
- 內徑高度 300MM



ST2296S-3H NT\$ 4950

- 三層架 (掛·放兩用)
- 附5000SC-2掛架固定座 厚底
- TRIPLE RACK S
- 304 STAINLESS STEEL
- W280 X D150 X H675MM
- 內徑高度上層 250MM
- 內徑高度下層 300MM



ST3209 NT\$ 1250

- 單層轉角架
- CORNER RACK
- 304 STAINLESS STEEL
- W195 X D195 X H87MM



ST3209-2 NT\$ 2550

- 雙層轉角架
- CORNER RACK DOUBLE
- 304 STAINLESS STEEL
- W195 X D195 X H348MM
- 內徑高度 270MM



ST2295S-2H NT\$ 2700

- 小方型雙層置物架
- 附5000SC-2掛架固定座 厚底
- DOUBLE SMALL RACK
- 304 STAINLESS STEEL
- W225 X D152 X H350MM
- 內徑高度 230MM



ST2297-2H NT\$ 3900

- 大方型雙層置物架
- 附5000SC-2掛架固定座 厚底
- DOUBLE LARGE RACK
- 304 STAINLESS STEEL
- W320 X D233 X H425MM
- 內徑高度 280MM



ST3208A-2 NT\$ 2700

- 雙層抽取式衛生紙架
- DOUBLE FACIAL TISSUE HOLDER
- 304 STAINLESS STEEL
- W280 X D120 X H365 MM
- 內徑高度 250MM



ST3033SH NT\$ 2000

- W225 X D225 X H175MM

ST3033H NT\$ 2500

- W320 X D320 X H175MM

- 轉角架-釘式
- 附5000SC-2掛架固定座 厚底
- CORNER RACK
- 304 STAINLESS STEEL



ST3208 NT\$ 1250

- 抽取式衛生紙架
- FACIAL TISSUE BOX
- 304 STAINLESS STEEL
- W265 X D120 X H90MM

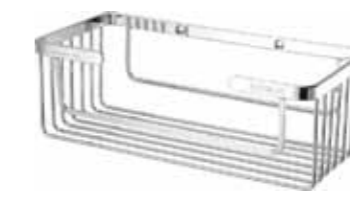

ST3208A NT\$ 1250

- 抽取式衛生紙架
- FACIAL TISSUE HOLDER
- 304 STAINLESS STEEL
- W256 X D120 X H90MM



1008T-8 NT\$ 1200

- 抽取式衛生紙盒-掛放兩用-白色
- FACIAL TISSUE BOX (ACRYLIC)
- ACRYLIC 壓克力
- W250 X D150 X H115MM
- (厚度 5MM)





ST2295-2H NT\$ 3600

- 方形雙層活動架 (釘式)
- 附 5000C-2 掛架固定座 薄底
- DOUBLE ACTIVE RACKS
- 304 STAINLESS STEEL
- W280 X D170 X H480MM
- 內徑高度 268MM



ST2297B-2 NT\$ 3800

- 雙層活動架
- 附 4000C-2 掛架固定座
- DOUBLE ACTIVE RACKS
- 304 STAINLESS STEEL
- W285 X D270 X H455MM
- 內徑高度 257MM



ST2297B-3 NT\$ 5100

- 三層活動架
- 附 4000C-2 掛架固定座
- TRIPLE ACTIVE RACKS
- 304 STAINLESS STEEL
- W285 X D270 X H775MM
- 內徑高度 上層 254MM
- 內徑高度 下層 306MM



ST2296SSH NT\$ 1650

- W280 X D175 X H95MM

ST2297SSH NT\$ 1500

- W280 X D140 X H95MM

ST2297LSH NT\$ 1700

- W320 X D145 X H95MM

- 小方形置物架
- 附5000SC-2掛架固定座 厚底
- SINGLE TRAY S
- 304 STAINLESS STEEL



ST2297LLH NT\$ 2400

- 大方形置物架
- 附 3061-30 滴水盤 X1
- 附 5000SC-2 掛架固定座 厚底
- SINGLE TRAY L
- 304 STAINLESS STEEL
- W320 X D225 X H110MM



ST2297SLH NT\$ 1900

- 大方形置物架-不附滴水盤
- 附 5000SC-2掛架固定座 厚底
- SINGLE TRAY L
- 304 STAINLESS STEEL
- W280 X D235 X H95MM



ST2299-2H NT\$ 3000

- 半圓形雙層活動架 (釘式)
- 附 5000C-2 掛架固定座 薄底
- DOUBLE ACTIVE RACKS (1/2 ROUND)
- 304 STAINLESS STEEL
- W270 X D150 X H480MM
- 內徑高度 271MM



ST2299B-2 NT\$ 3200

- 半圓形雙層活動架 (掛式 - 可活動)
- 附 4000C-2 掛架固定座
- DOUBLE ACTIVE RACKS (1/2 ROUND)
- 304 STAINLESS STEEL
- W270 X D150 X H460MM
- 內徑高度 255MM



ST2299B-3 NT\$ 4500

- 半圓形三層活動架 (掛式 - 可活動)
- 附 4000C-2 掛架固定座
- TRIPLE ACTIVE RACKS (1/2 ROUND)
- 304 STAINLESS STEEL
- W270 X D150 X H775MM
- 內徑高度 上層 257MM
- 內徑高度 下層 302MM



ST1008 NT\$ 1650

- 平版衛生紙架
- 附5000SC-2掛架固定座 厚底
- TOILET PAPER RACK
- 304 STAINLESS STEEL
- W235 X D217 X H95MM



ST2295SH NT\$ 1500

- 小方形置物架
- 附5000SC-2掛架固定座 厚底
- SINGLE TRAY S
- 304 STAINLESS STEEL
- W225 X D145 X H95MM



ST2299LH NT\$ 1400

- 半圓置物架
- 附 5000SC-2掛架固定座 厚底
- SINGLE TRAY
- 304 STAINLESS STEEL
- W270 X D150 X H100MM



ST2299-2 NT\$ 3350

- 半圓形淋浴拉門活動架
- SHOWER DOOR DOUBLE RACKS (1/2 ROUND)
- 304 STAINLESS STEEL
- W270 X D275 X H950MM
- 淋浴拉門厚度 65MM
- 內徑高度 311MM



ST2295-2 NT\$ 3900

- 方形淋浴拉門活動架
- SHOWER DOOR DOUBLE RACKS
- 304 STAINLESS STEEL
- W280 X D260 X H950MM
- 淋浴拉門厚度 65MM
- 內徑高度 308MM



ST3205 NT\$ 700

- 面紙架 (釘式)
- FACIAL TISSUE HOLDER
- 304 STAINLESS STEEL
- W135 X D105 X H195MM



ST3205T NT\$ 900

- 面紙架 (釘式) 可橫、直用
- FACIAL TISSUE HOLDER
- 304 STAINLESS STEEL
- W150 X D125 X H235MM



ST5230A NT\$ 1350

- 衛生紙架 (單瓶架)
- 可浴櫃內用
- FACIAL TISSUE HOLDER
- 304 STAINLESS STEEL
- W310 X D110 X H115MM



1006W NT\$ 3200

(實景詳見左圖)

- 壁掛式雙面伸縮鏡
- CHROME PLATING不鏽鋼色
- 伸縮桿為青銅材質
- 底座為 304不鏽鋼
- REVERSIBLE WALL-EXTENSION MIRROR
- 鏡面 Ø190MM
- 伸縮長度：一段175MM 二段330MM
- 平面·放大(放大兩倍)

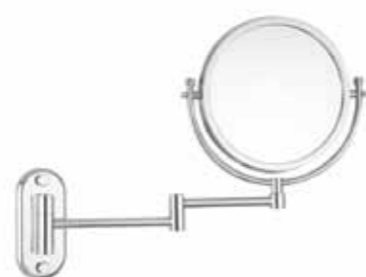

STA0010 NT\$ 3300

- 壁掛式雙面伸縮鏡
- 304 不鏽鋼
- REVERSIBLE WALL-EXTENSION MIRROR
- 304 STAINLESS STEEL
- 鏡面 Ø180MM
- 底座 W48 X H125MM
- 伸縮長度：
一段 245MM / 二段 445MM
- 平面·放大(放大三倍)



3612 不鏽鋼色 W 30CM NT\$ 1400

3618 不鏽鋼色 W 45CM NT\$ 1500

- 扶手
- BRASS 青銅材質
- GRAB BAR

1006LC NT\$ 2500

- 桌上型雙面明鏡
- 平面·放大(放大兩倍)
- 鏡面 Ø190MM
- PORTABLE 2-SIDE MIRROR
- CHROME PLATING 不鏽鋼色
- BRASS 青銅材質
- W270 X D130 X H350MM



1006SC NT\$ 2000

- 桌上型明鏡
- PORTABLE MIRROR
- CHROME PLATING 不鏽鋼色
- BRASS 青銅材質
- W165 X D110 X H300MM



STA0001 NT\$ 900

- 牙刷杯架
- 304 不鏽鋼
- 附透明玻璃杯 GLASS CUP
- TUMBLER CUP WITH HOLDER
- 304 STAINLESS STEEL
- W67 X D110 X H100MM



STA0002 NT\$ 900

- 香皂盤架
- 304 不鏽鋼
- 附透明香皂盤 GLASS SOAP
- SOAP DISH WITH HOLDER
- 304 STAINLESS STEEL
- W110 X D130 X H68MM



1023 NT\$ 130

- 透明玻璃牙刷杯
- TOOTH-BRUSH CUP
- GLASS
- Ø70X H95MM



STA0003 NT\$ 1200

- 吹風機架
- 適用負離子吹風機
- HAIR DRYER HOLDER
- 304 STAINLESS STEEL
- W93 X D135 X H60MM
- 圓內徑 86MM



2002BF NT\$ 600

- 吹風機架(大)
- BLOWER HOLDER
- CHROME PLATING 不鏽鋼色
- 圓內徑 95MM



1024 NT\$ 180

- 透明玻璃 香皂盤
- SOAP DISH
- GLASS
- Ø110 X H40MM



3506A NT\$ 70

- 肥皂盒
- SOAP DISH
- 適用ST6632A-2、ST6632A、3506



ST3207T NT\$ 450

- 肥皂架 掛、放兩用
- SOAP HOLDER
- 304 STAINLESS STEEL
- W140 X D90 X H20MM



ST3207 NT\$ 370

- 肥皂架(桌上型)
- SOAP HOLDER
- 304 STAINLESS STEEL
- W140 X D90 X H20MM



ST6632 NT\$ 1900

(實景詳見頁 22)

- 多功能盥洗架
- 附壓克力牙刷杯X2 壓克力香皂盤X1
- 可另選購7000C-2 或 7200C-2 螺絲固定座
- MULTI-FUNCTION TUMBLER HOLDER
- 304 STAINLESS STEEL
- W310 X D170 X H142MM



ST6632A-2 NT\$ 1600

- 多功能盥洗架組
- 附活動式杯架X2
- 可另選購香皂盤(3506A)
- MULTI-FUNCTION BRUSH HOLDER
- 304 STAINLESS STEEL
- W298 X D150 X H120MM

ST6632A NT\$ 950

- 小型多功能盥洗架 S
- MULTI-FUNCTION BRUSH HOLDER S
- 304 STAINLESS STEEL
- W125 X D150 X H120MM



ST6632B NT\$ 350

- 活動式杯架
- ACTIVE CUP RACK
- 304 STAINLESS STEEL
- W90 X D90 X H35MM



2005GA NT\$ 100

- 壓克力牙刷杯
- TOOTH-BRUSH CUP
- ACRYLIC



2006GA NT\$ 180

- 壓克力皂盤
- SOAP DISH
- ACRYLIC





NEW

STA0007 NT\$ 800

- 單掛衣勾
- 304 不鏽鋼
- SINGLE ROBE HOOK
- 304 STAINLESS STEEL
- W60 X D57 X H60MM



NEW

STA0008 NT\$ 900

- 雙掛衣勾
- 304 不鏽鋼
- DOUBLE ROBE HOOK
- 304 STAINLESS STEEL
- W90 X D70 X H60MM



NEW

STA0005 NT\$ 1350

- 馬桶刷架
- 304 不鏽鋼
- 附霧面玻璃杯 & 馬桶刷
- TOILET BRUSH & GLASS CUP WITH HOLDER
- 304 STAINLESS STEEL
- W112 X D132 X H345MM
- 圓內徑 86MM



NEW

STA0006 NT\$ 150

- 馬桶刷
- 304 不鏽鋼
- TOILET BRUSH
- 304 STAINLESS STEEL
- W335MM



NEW

1025 NT\$ 250

- 霧面玻璃 馬桶刷杯
- TOILET BRUSH CUP
- GLASS
- Ø115 X H112MM



NEW

STA0009 NT\$ 1800

- 手機及捲筒衛生紙架
- 304 不鏽鋼
- PAPER ROLL & PHONE HOLDER
- 304 STAINLESS STEEL
- W185 X D118 X H78MM



NEW

STA0011 NT\$ 1000

- 浴巾架
- 304 不鏽鋼
- BIGGER TOWER RING
- 304 STAINLESS STEEL
- W170 X D67 X H195MM
- 圓內徑：145MM



2001C NT\$ 750 (實景詳見頁 24)

- 毛巾環
- TOWEL RING
- CHROME PLATING 不鏽鋼色
- W160 X D65 X H180MM
- 圓內徑140MM



2002BC NT\$ 1420

- 馬桶刷架
- 青銅固定座
- 附馬桶刷 & 瓷杯
- TOILET BRUSH & PORCELAIN CUP WITH BRASS HOLDER
- W122 X D152 X H400MM
- 圓內徑 95MM



2002BD NT\$1100

- 馬桶刷架
- 青銅固定座
- 附馬桶刷 & 玻璃杯
- TOILET BRUSH & GLASS CUP WITH BRASS HOLDER
- W123 X D151 X H420MM
- 圓內徑 95MM



2002CB NT\$ 250

- 馬桶刷
- TOILET BRUSH
- CHROME PLATING 不鏽鋼色
- W390MM



2003CC NT\$ 1100

- 捲筒衛生紙架
- 蓋子為 304 不鏽鋼鏡面拋光
- PAPER HOLDER WITH LID 304 STAINLESS STEEL
- CHROME PLATING 不鏽鋼色
- W160 X D65 X H109MM



2303-01 NT\$ 1100

- 捲筒衛生紙架(有蓋)
- 蓋子為 304 不鏽鋼鏡面拋光
- PAPER HOLDER WITH LID
- 304 STAINLESS STEEL
- CHROME PLATING 不鏽鋼色
- W168 X D70 X H110MM



2003C NT\$ 780

- 捲筒衛生紙架(毛巾架)
- PAPER ROLL HOLDER (TOWEL HOLDER)
- CHROME PLATING 不鏽鋼色
- W160 X D65 X H100MM



2002GC NT\$ 600

- 馬桶刷杯
- TOILET BRUSH CUP
- 瓷器 PROCELAIN
- 有排水孔



2002G NT\$ 250

- 馬桶刷杯
- TOILET BRUSH CUP
- 玻璃 GLASS
- 有排水孔



雙層旋轉直立架



6650-01 NT\$ 5500

- CHROME PLATING 不鏽鋼色
- 桿子 H480MM
- 6691-1方型置物架(大)2個
HOLDER L (RECTANGLE SHAPE)
304 STAINLESS STEEL
W280 X D140 X H60 MM



6656C NT\$ 5400

- CHROME PLATING 不鏽鋼色
- 桿子H480MM
- 6691-1 方型置物架(大)
HOLDER L (RECTANGLE SHAPE)
304 STAINLESS STEEL
W280 X D140 X H60MM
- 6691-2 方型置物架(小)
HOLDER S (RECTANGLE SHAPE)
304 STAINLESS STEEL
W225 X D140 X H60MM



6650-02 NT\$ 5310

- CHROME PLATING 不鏽鋼色
- 桿子 H480MM
- 6691-1方型置物架(大)
HOLDER L (RECTANGLE SHAPE)
304 STAINLESS STEEL
W280 X D140 X H60 MM
- 6691-3圓形置物架
HOLDER S (ROUND SHAPE)
304 STAINLESS STEEL
Ø178 X H60MM



6650-03 NT\$ 4850

- CHROME PLATING 不鏽鋼色
- 桿子 H480MM
- 6691-1 方型置物架 (大)
HOLDER L (RECTANGLE SHAPE)
304 STAINLESS STEEL
W280 X D140 X H60MM
- 6670-2C 毛巾環架
SMALL TOWEL RING
Ø160MM 圓內徑 140MM



6650-07 NT\$ 5010

- CHROME PLATING 不鏽鋼色
- 桿子 H480MM
- 6691-3 圓形置物架
HOLDER S (ROUND SHAPE)
304 STAINLESS STEEL
Ø178 X H60MM
- 6670-1C 衛生紙架(有蓋)
TOILET PAPER HOLDER WITH LID
W165 X D110MM



6650-08 NT\$ 5200

- CHROME PLATING 不鏽鋼色
- 桿子 H480MM
- 6691-1 方型置物架 (大)
HOLDER L (RECTANGLE SHAPE)
304 STAINLESS STEEL
W280 X D140 X H60MM
- 6670-1C 衛生紙架(有蓋)
TOILET PAPER HOLDER WITH LID
W165 X D110MM

三層旋轉直立架



6670-01 NT\$ 7160

- CHROME PLATING 不鏽鋼色
- 桿子 H695MM
- 6691-1方型置物架(大)
HOLDER L (RECTANGLE SHAPE)
304 STAINLESS STEEL
W280 X D140 X H60 MM
- 6691-2方型置物架(小)
HOLDER S (RECTANGLE SHAPE)
304 STAINLESS STEEL
W225 X D140 X H60 MM
- 6691-3圓形置物架
HOLDER S (ROUND SHAPE)
304 STAINLESS STEEL
Ø178 X H60 MM



6670-07 NT\$ 7050

- CHROME PLATING 不鏽鋼色
- 桿子 H695MM
- 6691-1 方型置物架 (大)
HOLDER (RECTANGLE SHAPE)
304 STAINLESS STEEL
W280 X D140 X H60MM
- 6691-2 方型置物架 (小)
HOLDER S (RECTANGLE SHAPE)
304 STAINLESS STEEL
W225 X D140 X H60MM
- 6670-1C 衛生紙架(有蓋)
TOILET PAPER HOLDER WITH LID
W165 X D110MM



6670-03 NT\$ 7260

- CHROME PLATING 不鏽鋼色
- 桿子 H695MM
- 6691-1方型置物架(大)2個
HOLDER L (RECTANGLE SHAPE)
304 STAINLESS STEEL
W280 X D140 X H60 MM
- 6691-3圓形置物架
HOLDER S (ROUND SHAPE)
304 STAINLESS STEEL
Ø178 X H60 MM



6670-08 NT\$ 6800

- CHROME PLATING 不鏽鋼色
- 桿子 H695MM
- 6691-1 方型置物架 (大) 2 個
HOLDER (RECTANGLE SHAPE)
304 STAINLESS STEEL
W280 X D140 X H60MM
- 6670-2C 毛巾環架
TWOEL RING
Ø160MM 圓內徑 140MM



6670-05 NT\$ 7450

- CHROME PLATING 不鏽鋼色
- 桿子 H695MM
- 6691-1 方型置物架 (大) 3 個
HOLDER (RECTANGLE SHAPE)
304 STAINLESS STEEL
W280 X D140 X H60MM



6670-09 NT\$ 6610

- CHROME PLATING 不鏽鋼色
- 桿子 H695MM
- 6691-1 方型置物架 (大)
HOLDER (RECTANGLE SHAPE)
304 STAINLESS STEEL
W280 X D140 X H60MM
- 6691-3 圓形置物架
HOLDER S (ROUND SHAPE)
304 STAINLESS STEEL
Ø178 X H60MM
- 6670-2C 毛巾環架
TWOEL RING
Ø160MM 圓內徑 140MM

採用新一代無鉛無銅無毒製程

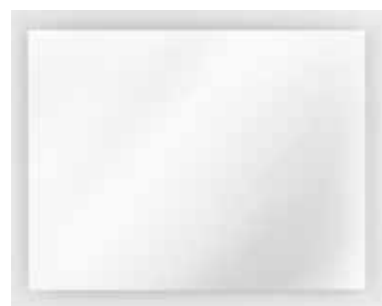

M-H919 NT\$ 13900

(實景詳見頁 29)

- LED 防霧鏡
- 橫掛
- 開關：右下揮手
- W800 X H600MM



NEW

M-H716 NT\$ 12500

(實景詳見頁 28 右下)

- LED 防霧鏡
- 橫掛
- 開關：右下觸碰
- W800 X H600MM



M-H720 NT\$ 12000

- LED 噴砂防霧鏡 + 時間
- 直掛
- 開關：右下揮手
- W500 X H700MM



M-526 NT\$ 4100

- 雙層防霧鏡(可橫、直掛)
- MIRROR
- W480 X H680MM



M-1006 NT\$ 3000

- 橢圓形防霧鏡
- MIRROR
- W480 X H680MM

易潔鏡專區

易潔鏡特色

採用特定奈米鍍模塗層，水氣不易凝結。
髒污、水漬不易附著於鏡子表面，鏡面用清水即可清潔。



M-1195 NT\$ 5600

(實景詳見頁 28 左上)

- 雙層易潔鏡(可橫、直掛)
- MIRROR
- W680 X H480MM



M-1528 NT\$ 4600

- 鑽雕易潔鏡(可橫、直掛)
- MIRROR
- W700 X H500MM



M-1005 NT\$ 3000

- 長方形防霧鏡(可橫、直掛)
- MIRROR
- W680 X H480MM



6008G W560 X H600MM NT\$ 3400

6008GL W800 X H600MM NT\$ 4200

- 方形防霧鏡(可橫、直掛)
- MIRROR

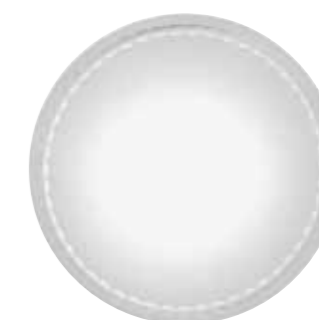

8008G NT\$ 3700

- 圓形防霧鏡
- MIRROR
- φ 585MM



M-122 NT\$ 3300

- W600 X H450MM

M-122L NT\$ 5200

- W800 X H600MM
- 長方形易潔鏡(可橫、直掛)
- MIRROR



NEW

M-1023B NT\$ 8000

- 長方形易潔鏡(可橫、直掛)
- 黑色 鋁框
- W600 X H800MM



NEW

M-1026B NT\$ 8700

- 圓型明鏡 黑色
- 鋁框
- MIRROR
- Ø585MM

符合台灣 CNS、日本 JIS R3202、歐盟 ROHS、北美 ASTM 檢驗標準。經 CASS Test (ASTM B368) 480hrs 實驗證實，更具耐腐蝕性與耐候性。使用台玻電子級專用玻璃製鏡。

產品優點：

抗化學性耐腐蝕性能，為傳統一般鏡 4 倍以上。
無鉛無銅無毒製程，符合環保訴求。
為世界未來發展主流趨勢是綠色環保裝飾建材新選擇。

鏡子清潔保養方式：

使用後請關掉電源。
請先以濕布擦鏡子，然後用乾布將鏡面水份擦淨，可讓鏡面潔淨。
請勿以強酸、強鹼清潔劑清洗鏡面。
請勿用水沖洗鏡面及開關。





3507 NT\$ 1650

- 鏡子平台架
- 附 3500-2 固定座 / 一對
- 10MM GLASS SHELF WITH 3500-2 HOLDER
- 10MM 霧面強化玻璃
- W600 X D145MM



3500-2 NT\$ 900/ 一對

- 固定座 / 一對 HOLDER
- CHROME PLATING 不鏽鋼色
- BRASS 青銅材質
- 可夾玻璃最大厚度 10MM
- W50 X D25 X H26MM

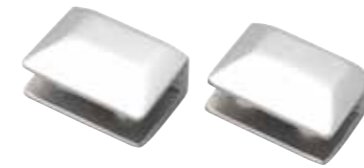

NEW

STH3700-2 NT\$ 1500/ 一對

- 固定座 / 一對 HOLDER
- 304 不鏽鋼鏡面拋光
- 304 STAINLESS STEEL
- 可夾玻璃最大厚度 10MM
- W50 X D35 X H21MM



NEW

STH3707 NT\$ 2250

- 鏡子平台架
- 附 STH3700-2 固定座 / 一對
- 10MM GLASS SHELF WITH STH3700-2 HOLDER
- 10MM 霧面強化玻璃
- W600 X D145MM

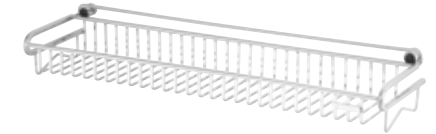

ST3268XL NT\$ 3050

- 平台置物架
- 附 5000SC-2 掛架固座 厚底
- MIRROR RACK
- 304 STAINLESS STEEL
- W600 X D160 X D90MM



3508MCG NT\$ 1500

- W400 X D146MM

3508CG NT\$ 1750

- W600 X D146MM

3508CGL NT\$ 2000

- W800 X D146MM
- 鏡子平台架
- 附 3500-2 固定座 / 一對
- 10MM GLASS SHELF WITH 3500-2 HOLDER
- 10MM OG 邊強化玻璃



3517 NT\$ 2300 (實景詳見上圖)

- 霧面玻璃平台架 - 附圍欄
- 附 3500-2 固定座 / 一對
- 10MM GLASS SHELF WITH RAIL & 3500-2 HOLDER
- 10MM 霧面強化玻璃
- W600 X D150MM



2007CG NT\$ 1600

- 10MM強化玻璃鏡子平台架
- 10MM GLASS SHELF
- CHROME PLATING 不鏽鋼色
- W600XD155MM



2017 NT\$ 2250

- 透明玻璃平台架-附圍欄
- 10MM強化玻璃鏡子平台架
- 10MM GLASS SHELF WITH RAIL
- W600 X D160MM



2217 NT\$ 650

- 平台圍欄組
- RAIL FOR GLASS SHELF
- 304 STAINLESS STEEL
- W551 X H36MM



NEW

STH3717 NT\$ 2900

- 霧面玻璃平台架 - 附圍欄
- 附 STH3700-2 固定座 / 一對
- 10MM GLASS SHELF WITH RAIL & STH3700-2 HOLDER
- 10MM 霧面強化玻璃
- W600 X D150MM



NEW

STH3708MCG NT\$ 2100

- W400 X D146MM

STH3708CG NT\$ 2350

- W600 X D146MM

STH3708CGL NT\$ 2600

- W800 X D146MM

- 鏡子平台架
- 附 STH3700-2 固定座 / 一對
- 10MM GLASS SHELF WITH STH3700-2 HOLDER
- 10MM OG 邊強化玻璃



3523MK NT\$ 1750

- 轉角架 - 附圍欄
- 附 3500-2 固定座一對
- 8MM GLASS CORNER HOLDER WITH 3500-2 HOLDER
- 8MM OG 邊強化玻璃
- W250 X D250MM



3512MFG NT\$ 1850

- 轉角架 - 附圍欄
- 附 3500-2 固定座 / 一對
- 8MM GLASS CORNER HOLDER WITH 3500-2 HOLDER
- 8MM OG 邊強化玻璃
- W250 X D250MM



3511CG NT\$ 1600

- 轉角架
- 附 3500-2 固定座 / 一對
- 10MM GLASS CORNER HOLDER WITH 3500-2 HOLDER
- 10MM OG 邊強化玻璃
- W280 X D280MM



NEW

STH3723MK NT\$ 2350

- 轉角架 - 附圍欄
- 附 STH3700-2 固定座一對
- 8MM GLASS CORNER HOLDER WITH STH3700-2 HOLDER
- 8MM OG 邊強化玻璃
- W250 X D250MM



NEW

STH3712MFG NT\$ 2450

- 轉角架 - 附圍欄
- 附 STH3700-2 固定座 / 一對
- 8MM GLASS CORNER HOLDER WITH STH3700-2 HOLDER
- 8MM OG 邊強化玻璃
- W250 X D250MM



NEW

STH3711CG NT\$ 2200

- 轉角架
- 附 STH3700-2 固定座 / 一對
- 10MM GLASS CORNER HOLDER WITH STH3700-2 HOLDER
- 10MM OG 邊強化玻璃
- W280 X D280MM



ST3015H NT\$ 2400

- (實景詳見頁 32)
- 刀柄砧板架 掛式
 - 附 3061-25 滴水盤 X1
 - KNIFE & CARVING BOARD HOLDER
 - 304 STAINLESS STEEL
 - W250 X D170 X H458MM
 - 砧板厚度 45MM



ST3215TS NT\$ 2000 (實景詳見頁 31)

- 桌上型刀柄砧板架
- 附 3061-20 滴水盤 X1
- KNIFE CARVING BOARD STAND
- 304 STAINLESS STEEL
- W185 X D150 X H235MM
- 砧板厚度 30MM



ST3015T NT\$ 1350

- 桌上型刀柄鍋蓋架
- 附 3061-20 滴水盤 X1
- KNIFE & LID STAND
- 304 STAINLESS STEEL
- W203 X D142 X H235MM



ST3026T NT\$ 650

- (實景詳見頁 44)
- 桌上型砧板架
 - CARVING BOARD STAND
 - 304 STAINLESS STEEL
 - W155 X D123 X H120MM
 - 砧板厚度 30 / 30MM



ST3215T NT\$ 1800 (實景詳見頁 36)

- 桌上型刀柄砧板架
- 附 3061-25L 滴水盤 X1
- KNIFE CARVING BOARD STAND
- 304 STAINLESS STEEL
- W290 X D165 X H255MM
- 砧板厚度 35 / 20MM



ST3215-1 NT\$ 1700

- 桌上型刀柄砧板架 (單層砧板架)
- 附 3061-25L 滴水盤 X1
- KNIFE CARVING BOARD STAND
- 304 STAINLESS STEEL
- W290 X D165 X H255MM
- 砧板厚度 50MM



ST3015C NT\$ 1550

- 刀柄架 掛式
- KNIFE HOLED R
- 304 STAINLESS STEEL
- W250 X D90 X H415MM



ST3023F NT\$ 2750

- 雙層調味罐架 掛式
- 可放保鮮膜、調味罐
- SPICE RACK
- 304 STAINLESS STEEL
- W300 X D192 X H360MM
- 內徑高度 140MM



ST3030L NT\$ 2000

- 調味罐架
- 可放保鮮膜、調味罐
- SPICE RACK
- 304 STAINLESS STEEL
- W350 X D180 X H275MM
- 內徑高度 125MM

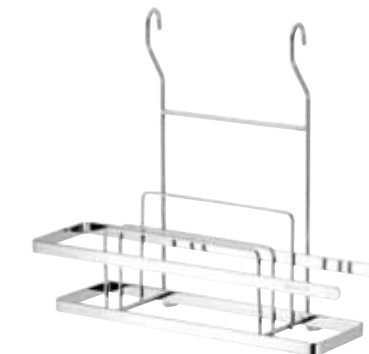

ST3026C NT\$ 2350

- 砧板架 掛式
- CARVING BOARD RACK
- 304 STAINLESS STEEL
- W405 X D145 X H350MM
- 砧板厚度 23 / 30 / 30MM



ST3015ST-01 NT\$ 1150

- 刀柄架 門板釘式
- 可加購 5000C-2 掛架固定座
- KNIFE HOLDER
- 304 STAINLESS STEEL
- W245 X D60 X H265MM



ST3215L NT\$ 2100

- 桌上型 刀柄 砧板 鍋蓋架
- 附 3061-30 滴水盤 X 1
- KNIFE & CARVING BOARD & LID STAND
- 304 STAINLESS STEEL
- W300 X D230 X H 255MM
- 鍋蓋深度 83 MM
- 砧板厚度 43 MM



ST3015F NT\$ 2700

- 刀柄 砧板 鍋蓋架 掛式
- 附 3061-25 滴水盤 X 1
- KNIFE & CARVING BOARD & LID HOLDER
- 304 STAINLESS STEEL
- W257 X D187 X H443MM
- 鍋蓋深度 78 MM
- 砧板厚度 43 MM



ST3023H NT\$ 3100

- 桌上型雙層調味架
- 附 3061-25L 滴水盤 X1
- 附 5000SC-2 掛架固定座 厚底
- DOUBLE SPICE RACKS
- 304 STAINLESS STEEL
- W300 X D178 X H307MM
- 內徑高度 170MM





ST3088AH NT\$ 1650

- 單層活動架
- 附 5000SC-2 掛架固定座 厚底
- SINGLE ACTIVE RACK
- 304 STAINLESS STEEL
- W335 X D145 X H93MM

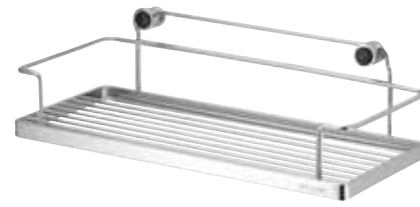

ST3088BH NT\$ 1600

- 單層調味架
- 附5000SC-2掛架固定座 厚底
- SINGLE SPICE RACK
- 304 STAINLESS STEEL
- W335 X D145 X H93MM



NEW

ST3088-2 NT\$ 3250

- 雙層活動式調味架
- DOUBLE SPICE ACTIVE RACKS
- 304 STAINLESS STEEL
- W335 X D175 X H470MM
- 內徑高度 250MM



ST3020 NT\$ 2350

- 多用途掛架 長勾
- MULTI-PURPOSE RACK
- 304 STAINLESS STEEL
- W455 X D185 X H330MM



ST3020S NT\$ 2150

- 多用途掛架 短勾
- MULTI-PURPOSE RACK
- 304 STAINLESS STEEL
- W455 X D185 X H210MM



ST3028C NT\$ 3000 (實景詳見下圖)

- 調味罐及瓶罐架
- SPICE WITH BOTTLE RACK
- 304 STAINLESS STEEL
- W400 X D200 X H360MM



ST3088A NT\$ 1950

- 單層活動架
- SINGLE ACTIVE RACK
- 304 STAINLESS STEEL
- W335 X D155 X H285MM



ST3088B NT\$ 1900

- 單層調味架
- SINGLE SPICE RACK
- 304 STAINLESS STEEL
- W335 X D155 X H285MM



NEW

ST3088F-2 NT\$ 3250

- 冰箱雙層活動式調味架
- DOUBLE SPICE ACTIVE RACKS FOR REFRIGERATOR
- 304 STAINLESS STEEL
- W335 X D202 X H445MM
- 內徑高度 290MM



ST3029-01 NT\$ 1800

- 桌上型雙層調理罐架 (實景詳見頁 33)
- DOUBLE SPICE RACKS
- 304 STAINLESS STEEL
- W305 X D105 X H280MM
- 內徑高度 156MM



ST3029 NT\$ 2300

- 瓶罐架
- BOTTLE RACK
- 304 STAINLESS STEEL
- W450 X D210 X H300MM



ST3028 NT\$ 2750

- 調味罐及瓶罐架
- SPICE WITH BOTTLE RACK
- 304 STAINLESS STEEL
- W345 X D230 X H355MM



ST2297L NT\$ 4350

- 雙層活動掛架
- 附 3061-30 滴水盤 X1
- DOUBLE ACTIVE RACK W / PLATE
- 304 STAINLESS STEEL
- W320 X D250 X H455MM
- 內徑高度 232MM





ST3023 NT\$ 2600

- 調味罐及紙巾架
- SPICE WITH PAPER TOWEL HOLDER
- 304 STAINLESS STEEL
- W300 X D195 X H355MM



ST3023C NT\$ 2300

- 調味罐及紙巾架
- SPICE WITH PAPER TOWEL HOLDER
- 304 STAINLESS STEEL
- W330 X D140 X H300MM



ST3027B NT\$ 1000

- (實景詳見頁下圖)
- 鍋蓋架 掛式 附集水盒
 - LID HOLDER WITH A BOX
 - 304 STAINLESS STEEL
 - W205 X D140 X H455MM



ST3027C NT\$ 1050

- 鍋蓋架 釘式 附集水盒
- 附5000C-2掛架固定座 薄底
- LID HOLDER WITH A BOX
- 304 STAINLESS STEEL
- W205 X D140 X H415MM



ST3027F NT\$ 1250

- 鍋蓋砵板架-掛式 附集水盒
- LID & CARVING BOARD HOLDER
- 304 STAINLESS STEEL
- W205 X D160 X H470MM



3027P NT\$ 70

- 集水盒
- 適用 ST3027C、ST3027B、ST3027F

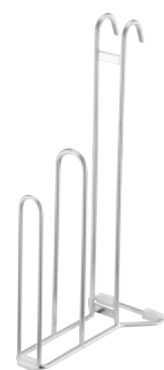

ST2003D NT\$ 850

- (實景詳見上圖)
- 紙巾架
 - 掛式及桌上型兩用
 - PAPER TOWEL HOLDER
 - 304 STAINLESS STEEL
 - W95 X D176 X H310MM



ST2003DL NT\$ 950

- 紙巾架-大型紙巾適用
- 掛式及桌上型兩用
- PAPER TOWEL HOLDER
- 304 STAINLESS STEEL
- W95 X D213 X H380MM



ST2003HA NT\$ 1100

- 桌上型紙巾架
- PAPER TOWEL STAND
- 304 STAINLESS STEEL
- 直徑 ϕ 162 X H300MM



ST3027-01 NT\$ 1350

- 桌上型鍋蓋砵板架
- 附 3061-25 滴水盤 X1
- LID & CARVING BOARD HOLDER
- 304 STAINLESS STEEL
- W255 X D170 X H190MM
- 砵板厚度 30 / 25MM
- 鍋蓋深度 58MM



ST3031 NT\$ 1500

- 桌上型平底鍋架 附滴水盤
- 附 3061-30 滴水盤 X 1
- SAUCEPAN STAND
- 304 STAINLESS STEEL
- W318 X D230 X H194MM



ST3027T NT\$ 1800

- 桌上型鍋蓋架
- 附 3061-25 滴水盤 X1
- LID STAND
- 304 STAINLESS STEEL
- W255 X D170 X H420MM



ST3006K NT\$ 800

- NEW
- 隔熱墊
 - HOT MAT
 - 304 STAINLESS STEEL
 - W238 X D200 X H15MM

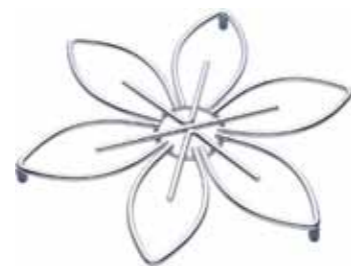

ST3006F NT\$ 700

- (實景詳見頁 43)
- 花型隔熱墊
 - FLOWER SHAPE HOT MAT
 - 304 STAINLESS STEEL
 - ϕ 240MM



ST3006L NT\$ 450

- ϕ 205MM
- **ST3006S** NT\$ 390
- ϕ 180MM
- 隔熱墊
- HOT MAT
- 304 STAINLESS STEEL





ST3078D-01 NT\$ 8300

- 雙層置物架
- 附 3061-50 滴水盤 X2
- 附 5000SC-2 掛架固定座 厚底
- ST3003-01 餐具桶、插盤架、單 S 掛勾 X3
- DOUBLE MULTI-PURPOSE RACK
- 304 STAINLESS STEEL
- W575 X D245 X H460MM
- 內徑高度 303MM

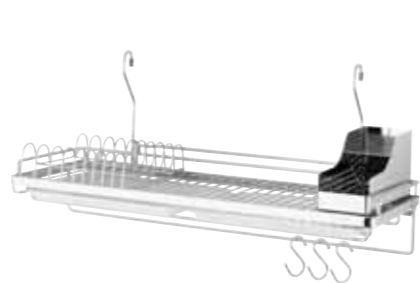

ST3068S-01 NT\$ 6200

- 碗盤架
- 附 3061-30 滴水盤 X2
- ST3003-01 餐具桶、插盤架、單 S 掛勾 X3
- BOWL AND DISHES RACK WITHOUT TUBE & HOLDER
- 304 STAINLESS STEEL
- W640 X D250 X H290MM

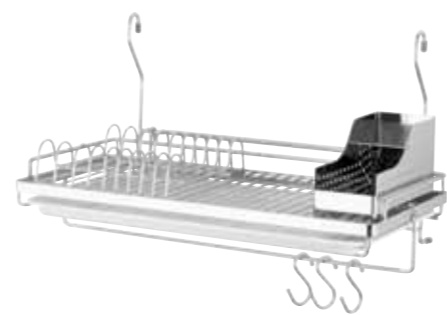

ST3078S-01 NT\$ 5650

- 碗盤架 - 掛式
- 附 3061-50 滴水盤 X1
- ST3003-01 餐具桶、插盤架、單 S 掛勾 X3
- BOWL AND DISHES RACK WITHOUT TUBE & HOLDER
- 304 STAINLESS STEEL
- W502 X D280 X H290MM



ST2298D-01 NT\$ 5950

- 碗盤架
- 附 3061-30 滴水盤 X2
- 附 5000LC-2 掛架固定座
- ST3003-01 餐具桶、插盤架
- BOWL AND DISHES RACK WITH 5000LC-2 HOLDER
- 304 STAINLESS STEEL
- W620 X D260 X H90MM

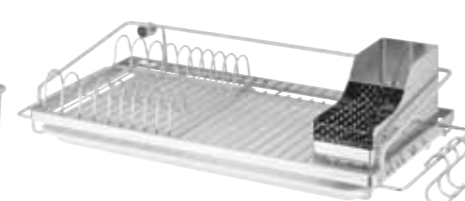

ST3078A-01 NT\$ 5050

- 碗盤架 - 釘式
- 附 3061-50 滴水盤 X1
- 附 5000SC-2 掛架固定座 厚底
- ST3003-01 餐具桶、插盤架、單 S 掛勾 X3
- SINGLE MULTI-PURPOSE RACK WITH 5000SC-2 HOLDER
- 304 STAINLESS STEEL
- W575 X D245 X H100MM



ST3078 NT\$ 2650

- 單層置物架
- 附 3061-50 滴水盤 X1
- 附 5000SC-2 掛架固定座 厚底
- SINGLE MULTI-PURPOSE RACK WITH 5000SC-2 HOLDER
- 304 STAINLESS STEEL
- W575 X D245 X H100MM



ST3078D NT\$ 7000

- 雙層置物架
- 附 3061-50 滴水盤 X2
- 附 5000SC-2 掛架固定座 厚底
- 插盤架、餐具盒、單 S 掛勾 X3、
- DOUBLE MULTI-PURPOSE RACK
- 304 STAINLESS STEEL
- W575 X D245 X H460MM
- 內徑高度 303MM



ST3068S NT\$ 4900

(實景詳見頁 38)

- 碗盤架
- 附 3061-30 滴水盤 X2
- 附插盤架、餐具盒、單 S 掛勾 X3
- BOWL AND DISHES RACK WITHOUT TUBE & HOLDER
- 304 STAINLESS STEEL
- W640 X D250 X H290MM



ST3078S NT\$ 4350

- 碗盤架 - 掛式
- 附 3061-50 滴水盤 X1
- 附插盤架、餐具盒、單 S 掛勾 X3
- BOWL AND DISHES RACK WITHOUT TUBE & HOLDER
- 304 STAINLESS STEEL
- W502 X D280 X H290MM



ST2298D NT\$ 4650

- 碗盤架
- 附 3061-30 滴水盤 X2
- 附 5000LC-2 掛架固定座
- 插盤架、餐具盒
- BOWL AND DISHES RACK WITH 5000LC-2 HOLDER
- 304 STAINLESS STEEL
- W620 X D260 X H90MM



ST3078A NT\$ 3750

- 碗盤架 - 釘式
- 附 3061-50 滴水盤 X1
- 附 5000SC-2 掛架固定座 厚底
- 插盤架、餐具盒、單 S 掛勾 X3
- SINGLE MULTI-PURPOSE RACK WITH 5000SC-2 HOLDER
- 304 STAINLESS STEEL
- W575 X D245 X H100MM



ST2297A NT\$ 2650

- 小型碗盤架
- 附 3061-30 滴水盤 X1
- SMALL BOWL AND DISHES RACK
- 304 STAINLESS STEEL
- W320 X D255 X H285MM

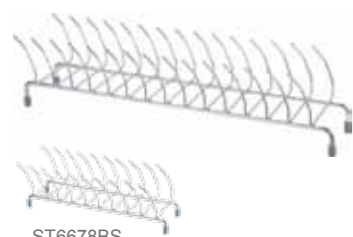

ST6678B NT\$ 750

- 14 格
- W400 X D90 X H100MM

ST6678BS NT\$ 600

- 9 格
- W270 X D90 X H90MM
- 碗盤架
- DISHES HOLDER
- 304 STAINLESS STEEL



ST6678C NT\$ 950

- 12 格
- W400 X D90 X H105MM

ST6678CS NT\$ 700

- 8 格
- W265 X D90 X H98MM
- 盤子架
- DISHES HOLDER
- 304 STAINLESS STEEL



ST3078F NT\$ 5900

- 雙層置物架 (掛、放兩用)
- 附 3061-50 大滴水盤 X2
- 附 5000SC-2 掛架固定座 厚底
- DOUBLE MULTI-PURPOSE RACK
- 304 STAINLESS STEEL
- W575 X D245 X H460MM
- 內徑高度 303MM



ST6678DP-01 NT\$ 5500

- 雙層置物架 (扁條)
- 附 5000C-2 掛架固定座 薄底
- 附 ST6678A 瓶罐架
- DOUBLE MULTI-PURPOSE RACK
- 304 STAINLESS STEEL
- W468 X D280 X H440MM





ST3060-01 NT\$ 950

- 碗架
- BOWL HOLDER
- 304 STAINLESS STEEL
- Ø 150 X H195MM

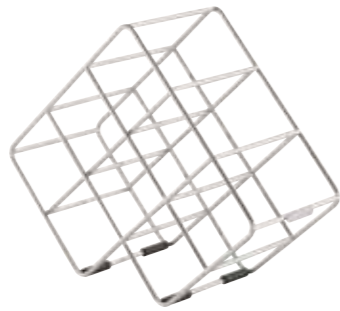

NEW

ST3055 NT\$ 2300

(實景詳見右圖)

- 紅酒架
- WINE HOLDER
- 304 STAINLESS STEEL
- W356 X D295 X H150MM

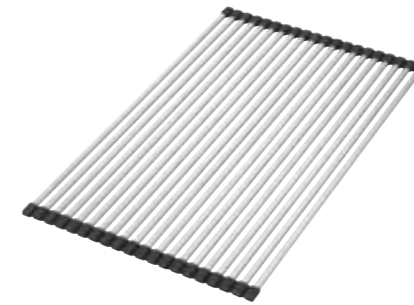

ST3052 NT\$ 3900

- 全展 W316 X D506MM
- 收納 Ø53 X D506MM
- 適用四方型水槽



- 滴水捲簾
- ROLLABLE DISHES HOLDER
- 304 STAINLESS STEEL
- 食用級耐熱矽膠
- 20支 304 不鏽鋼扁條



ST3052L NT\$ 4350

- 全展 W316 X D546MM
- 收納 Ø53 X D546MM
- 適用海灣型水槽



ST3060D NT\$ 1600

(實景詳見頁 40)

- 桌上型碗盤架
- 附 3061-30 滴水盤 X1
- DISHES HOLDER W/PLATE
- 304 STAINLESS STEEL
- W323 X D210 X H105MM



ST3060L NT\$ 1150

- 桌上型盤子架
- 附 3061-30 滴水盤 X1
- DISHES HOLDER
- 304 STAINLESS STEEL
- W312 X D226 X H110MM



ST3060 NT\$ 800

- 盤子架 可拉籃內用
- DISHES HOLDER
- 304 STAINLESS STEEL
- W205 X D205 X H60MM

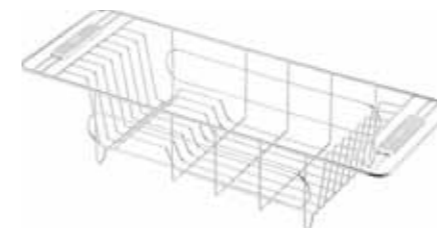

ST3013T NT\$ 1050

- 水槽碗盤籃
- DISHES DRAINER
- 304 STAINLESS STEEL
- W510X D188 X H110MM
- 內徑W325 X D175 X H95MM

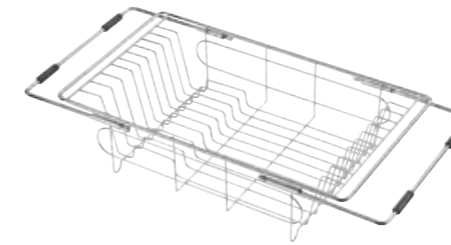

ST3013TL NT\$ 2050

- 可調式水槽碗盤籃
- ADJUSTABLE SINK BASKET
- 304 STAINLESS STEEL
- W430 X D255 X H110MM (全展 545MM)
- 內徑 W325 X D238 X H90MM



ST3013TD NT\$ 2300

(實景詳見下圖)

- 可調式水槽碗盤籃
- 附 3061-30 滴水盤 X1
- ADJUSTABLE SINK BASKET WITH PLATE
- 304 STAINLESS STEEL
- W430 X D255 X H130MM (全展 545MM)
- 內徑 W325 X D238 X H90MM



ST3008D-2 NT\$ 3250

- 桌上型雙層碗盤架
- 附 3061-30 滴水盤 X2
- DOUBLE MULTI-PURPOSE RACK
- 304 STAINLESS STEEL
- W350 X D230 X H315MM
- 內徑高度 220MM



ST3008D NT\$ 2150

- 桌上型置物盤
- 附 3061-30 滴水盤 X1
- DISHES HOLDER W/PLATE
- 304 STAINLESS STEEL
- W350 X D245 X H110MM



ST3008 NT\$ 2050

- 桌上型水果盤
- 附 3061-30 滴水盤 X1
- FRUIT HOLDER
- 304 STAINLESS STEEL
- W355 X D250 X H150MM



ST3051 NT\$ 1300

(實景詳見頁 43)

- 馬克杯架
- MUG TREE
- 304 STAINLESS STEEL
- W180 X D180 X H330MM



3010TC NT\$ 1850

- 可調式高腳杯架 桌上型
- ADJUSTABLE HANGING GLASS STAND
- 304 STAINLESS STEEL & 青銅材質
- W320 X D285 X H205MM(全展 355MM)
- 高腳杯入口徑 120MM

NEW



ST3003-07 NT\$ 1100

- 餐具桶
- 隔板可拆洗
- CUTLERY HOLDER
- 304 STAINLESS STEEL
- W121 X D75 X H110MM

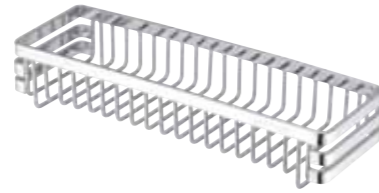

ST3003-02 NT\$ 1000

- 平放筷架
- CUTLERY HOLDER
- 304 STAINLESS STEEL
- W265 X D62 X H49MM



ST3003TS NT\$ 850
(實景詳見頁 40)

- 餐具桶
- CUTLERY HOLDER
- 304 STAINLESS STEEL
- W82 X D100 X H120MM



ST3016ST NT\$ 1450

- 杯子架 六個入
- 附 3061-25 滴水盤 X1
- CUP STAND
- 304 STAINLESS STEEL
- W265 X D165 X H230MM



ST3003T NT\$ 1400

- (實景詳見頁 43)
- 餐具桶 - 長方型
 - CUTLERY HOLDER
 - 304 STAINLESS STEEL
 - W178 X D103 X H151MM



ST3003TL NT\$ 1500

- 餐具桶 - 長方型
- 附滴水盤
- CUTLERY HOLDER
- 304 STAINLESS STEEL
- W212 X D107 X H152MM

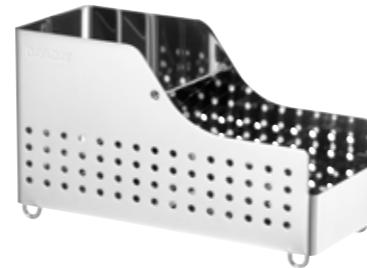

ST3003-01 NT\$ 1500

- 餐具桶
- CUTLERY HOLDER
- 304 STAINLESS STEEL
- W195 X D81 X H118MM



ST3016LT NT\$ 1700

- (實景詳見上圖)
- 杯子架 八個入
 - 附 3061-25L 滴水盤 X1
 - CUP STAND L
 - 304 STAINLESS STEEL
 - W305 X D165 X H235MM



ST3016 NT\$ 950

- 杯子架 六個入
- 附 3061-25 滴水盤 X1
- CUP STAND
- 304 STAINLESS STEEL
- W245 X D160 X H215MM



ST3016L NT\$ 1050

- 杯子架 八個入
- 附 3061-25L 滴水盤 X1
- CUP STAND L
- 304 STAINLESS STEEL
- W300 X D165 X H225MM



ST3003TT NT\$ 1700

- 餐具桶 - 長方型 掛式
- CUTLERY HOLDER
- 304 STAINLESS STEEL
- W178 X D126 X H290MM



ST3003TF NT\$ 1800

- 餐具桶 - 長方型 掛式
- 附滴水盤
- CUTLERY HOLDER
- 304 STAINLESS STEEL
- W212 X D132 X H290MM



ST3003 NT\$ 900

- 餐具桶 掛、放兩用
- CUTLERY HOLDER
- 304 STAINLESS STEEL
- W116 X D116 X H275MM



ST3053 NT\$ 1700

- (實景詳見左圖)
- 蛋糕架
 - 不附盤子
 - 盤子尺寸建議：Ø175~230MM
 - CAKE HOLDER
 - 304 STAINLESS STEEL
 - W240 X D125 X H378MM



ST3018LT NT\$ 1550

- 咖啡杯架 六個入
- 附 3061-25L 滴水盤 X1
- COFFEE CUP STAND
- 304 STAINLESS STEEL
- W310 X D170 X H237MM



ST3005-01 NT\$ 450

- 湯勺架
- 附 3061-10 滴水盤 X1
- SPOON HOLDER
- 304 STAINLESS STEEL
- Ø 120 X H48MM



ST3005 NT\$ 600

(實景詳見頁 32)

- 餐具架 桌上型
- 附 3061-10 滴水盤 X1
- SPOON HOLDER
- 304 STAINLESS STEEL
- W110 X D116 X H270MM



ST3203F NT\$ 1300

- 海綿置物架 - 掛式
- 附 3061-20 滴水盤 X1
- SPONGE HOLDER W/PATE
- 304 STAINLESS STEEL
- W225 X D172 X H285MM



ST3201 NT\$ 400

- 海綿架(附吸盤、螺絲)
- SPONGE HOLDER
- 304 STAINLESS STEEL
- W155 X D73 X H87MM



ST3202 NT\$ 800

(實景詳見 44 下圖)

- 海綿瓶罐籃(附吸盤 螺絲)
- SPONGE AND BOTTLE HOLDER
- 304 STAINLESS STEEL
- W180 X D130 X H100MM



ST3203D NT\$ 950

- 海綿置物架
- 附 3061-20 滴水盤 X1
- 附滴水盤 吸盤 螺絲
- SPONGE HOLDER W/PLATE
- 304 STAINLESS STEEL
- W225 X D125 X H85MM



ST3202Z NT\$ 950

- 海綿瓶罐籃
- 附 2800C 固定掛架
- 304 STAINLESS STEEL
- W180 X D130 X H100MM



ST3203Z NT\$ 1100

- 海綿置物架
- 附 2800C 固定掛架
- 304 STAINLESS STEEL
- W225 X D125 X H85MM



2800C 不鏽鋼色 NT\$ 150

- 固定掛架(不鏽鋼色 ST3201~ST3203D專用)
- HOLDER (USED BY ST3201~ST3203D)
- BRASS 青銅材質



3200P NT\$ 10/ 一個

- 吸盤
- 適用 ST3201、ST3202、ST3203D



ST3010SC NT\$ 600

- W327 X D150 X H40MM

ST3010LC NT\$ 650

- W387 X D150 X H40MM

- 高腳杯架
- 入口徑 120MM
- GOBLET RACK
- 304 STAINLESS STEEL



ST3010SC-2 NT\$ 1100

- W327 X D285 X H40MM

ST3010LC-2 NT\$ 1250

- W387 X D285 X H40MM

- 雙排高腳杯架
- 入口徑 120MM
- GOBLET RACK DOUBLE
- 304 STAINLESS STEEL



ST3012SC NT\$ 750

- 吊杯架(小)
- HANGING CUP RACK S
- 304 STAINLESS STEEL
- W300 X D86 X H50MM



ST3012LC NT\$ 850

- 吊杯架(大)
- HANGING CUP RACK L
- 304 STAINLESS STEEL
- W360 X D86 X H50MM



1003 NT\$ 180

(實景詳見下圖)

- 餐具盒(斜放、直放兩用)
- CUTLERY & TABLE WARE HOLDER
- ABS塑膠
- W200 X D85 X H138MM



1001L 乳白色 NT\$ 140

- 雙隔調味盒
- SEASONING CASE
- ABS塑膠
- W90 X D150 X H115MM



1001S 乳白色 NT\$ 120

- 單隔調味盒
- SEASONING CASE
- ABS塑膠
- W70 X D150 X H115MM



3061-20 NT\$ 85

- W203 X D140MM

3061-25 NT\$ 130

- W256 X D155MM

3061-25L NT\$ 150

- W300 X D155MM

3061-30 NT\$ 170

- W300 X D215MM

3061-50 NT\$ 350

- W475 X D240MM

- 滴水盤
- MELAMINE DISH
- 美耐皿

3061-10 NT\$ 55

- 圓滴水盤
- SMALL ROUND PLATE
- 美耐皿
- φ 110MM





NEW



V1030L NT\$ 5600

- 電子感應自動環保桶 – 橫向
- 430 不鏽鋼桶身 不鏽鋼色
- 附分隔式 可分類內桶
- 橫向向上
- 容量：30L (13+17L)
- W416 X D288 X H458MM
- 附 1 號電池 X 2



NEW

V1016L NT\$ 3200

- 電子感應自動環保桶 – 方型
- ABS 白色
- AUTO SENSITIVE DUSTBIN
- 方型上掀
- 容量：16L
- W240 X D241 X H383MM
- 附 3 號電池 X 2



V1012LH NT\$ 3500

- 電子腳觸自動環保桶 – 半圓
- 430 不鏽鋼桶身
- AUTO SENSITIVE DUSTBIN
- 半圓上掀
- 容量：12L
- W264 X D237 X H370MM
- 附 3 號電池 X 2



SA-15CT51 NT\$ 2600

- 縱向長方形垃圾桶
- 430 不鏽鋼桶身 (厚度 0.4MM)
- 緩降腳踏式
- DUSTBIN
- 容量：15L
- W230 X D405 X H445MM
- 塑膠內桶
W200 X D295 X H340MM



V1012LG NT\$ 3500

(實景詳見頁 46)

- 電子感應自動環保桶 - 橫向
- 430 不鏽鋼烤漆桶身 黑色
- AUTO SENSITIVE DUSTBIN
- 橫向上掀
- 容量：12L
- W261 X D198 X H355MM
- 附 3 號電池 X 2



V1012LF NT\$ 3500

- 電子感應自動環保桶 - 橫向
- 430 不鏽鋼桶身 不鏽鋼色
- AUTO SENSITIVE DUSTBIN
- 橫向上掀
- 容量：12L
- W261 X D198 X H355MM
- 附 3 號電池 X 2



SA-12CH66 NT\$ 2400

- 四方形垃圾桶
- 430 不鏽鋼桶身 (厚度 0.4MM)
- 緩降腳踏式
- DUSTBIN
- 容量 12L
- W252 X D320 X H450MM
- 塑膠內桶
- W240 X D235 X H350MM



SA-05EF51-01 NT\$ 1700

- 直向長形垃圾桶
- 430 不鏽鋼桶身 (厚度 0.4MM)
- 緩降腳踏式
- DUSTBIN
- 容量：5L
- W163 X D280 X H287MM
- 塑膠內桶
W163 X D216 X H236MM



V1008LA NT\$ 2400

- 電子感應自動環保桶 – 半圓
- ABS 白色
- AUTO SENSITIVE DUSTBIN
- 半圓上掀
- 容量：8L
- W244 X D191 X H280MM
- 附 3 號電池 X 2



V1007L NT\$ 2400

- 電子感應自動環保桶 - 直向
- ABS 白色
- AUTO SENSITIVE DUSTBIN
- 縱向上掀
- 容量：7L
- W150 X D230 X H310MM
- 附 3 號電池 X 2



採用 430 不鏽鋼，更堅固耐用，抗腐蝕性更強不易生鏽。
經 SGS 測試踩踏、按壓式設計開合可達 50000 次以上。

清潔方式：

請使用清水或中性清潔劑與乾布搭配擦拭表面，接著再
使用柔軟乾布輕擦並待其自然乾燥，勿用鋼刷刷洗。

注意事項：

- 請使用中性清潔劑與乾布搭配擦拭表面
- 勿接近高溫和火源
- 勿擠壓或碰撞重摔，以免商品變形
- 避免潮濕



關於歐瓦

AWA歐瓦廚衛精品水龍頭，以「創造智慧而精工」為品牌信仰，產品堅守設計、兼顧對人和環境的尊重、可回收再利用的材質與經久實用的品質，過去已多年成功營銷歐美市場。

歐瓦創辦人駱奎思(Christian Laudet)擁有長時間的水龍頭生產經驗，他個人曾分別於2010與2011年獲得德國紅點設計獎(Red Dot Award)，不僅於此，駱奎思更在成立歐瓦之後，再度獲得2013、2015紅點設計獎的肯定。與彰化鹿港水龍頭生產基地互動將近30年至今，積累豐富的台灣經驗。駱奎思觀察台灣民眾逐年地擴展設計接受度，決定帶領團隊於2015年正式在台灣啟動。結合省水節能的環保需求、視覺加上手感的震撼設計，企圖將歐洲追求迷人生活的精神引入台灣廚衛空間。

「現代法式設計，台灣製造」— 是歐瓦行腳台灣的核心，由法國設計師領軍多元文化的團隊，熱愛台灣、熱愛設計，堅信優雅、智慧、實用的產品可以在台灣令國際信賴的生產技術中實現，並以技術、設計、價格競爭力三面向的謹慎考量，制定台灣市場策略。

環保設計：

● 環保省水起泡頭

歐瓦使用德國高級紐珀(Neoperl)起泡頭濾網，讓水流混合空氣，水流綿密不外濺。產生極佳的觸感，省水40%。

● 輕鬆清洗起泡頭—出水口的起泡頭容易拆除清洗

自來水經自來水廠、水管、水塔等管道進入家中的水龍頭，會夾雜細沙及小石頭阻塞在出水的濾網。歐瓦的起泡器僅使用銅板或一字起旋轉的方式即可打開清洗。(一般傳統須使用鉗子等工具才可以打開清洗)

● 二段式陶瓷閥芯—西班牙製造

可調控的二段式陶瓷閥芯，節省其餘50%的出水量。二段式的操作方法，水龍頭打開，第一段的出水量較細，只有50%的出水量，再往上推時為第二段出水量較大。二段式在切換時，相當明顯，可讓使用者明確分辨處於第一段或是第二段。

● ECO節能手把—保護熱水器，減少開關次數

一般混合水龍頭常在使用時自動啟動熱水器，造成能源的浪費。歐瓦的節能手把當在使用時將把手開關置於中間再打開只有冷水流出，不會啟動熱水器，有效的節省瓦斯能源。

● 可回收銅鑄造

全銅製造，響應環保，可回收再利用。



單一把手設計



二段式陶瓷閥芯



ECO節能手把



可回收銅鑄造



輕鬆清洗起泡頭





SYDENY 檯面無鉛龍頭

EA-105-CB 鍍鉻 x 黑色烤漆

NT\$ 14800

- 省水起泡頭濾網
- 輕鬆清洗起泡頭濾網
- 二段式陶瓷閥芯
- 旋轉管身
- 適合小型廚房
- 德國紅點設計大獎 (Red Dot)

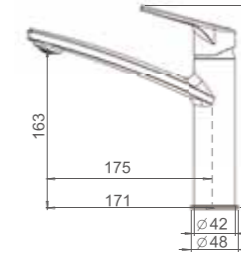

HANDY 檯面無鉛龍頭

EA-022-GB 黑色 x 玫瑰金

NT\$ 9200

- 省水起泡頭濾網
- 輕鬆清洗起泡頭濾網
- 二段式陶瓷閥芯
- 可旋轉 U 型噴嘴
- ECO 節能手把

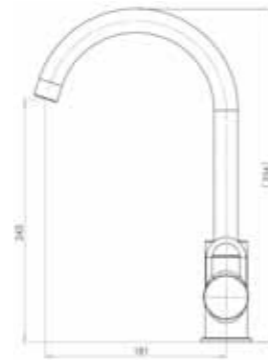

NEW

ROBIN 檯面無鉛龍頭

EA-194-N 絲光鍍銀

NT\$ 14700

- 省水起泡頭濾網
- 輕鬆清洗起泡頭濾網
- 二段式陶瓷閥芯
- ECO 節能手把
- 高品質軟管握把
- 握把經隔熱處理避免燙傷
- 可活動及收納式軟管

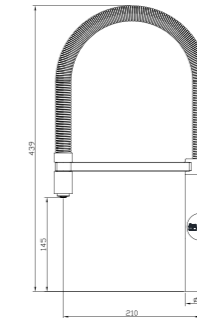

NEW

SHERLOCK 檯面無鉛龍頭

EA-071-BR

NT\$ 14700

- 省水起泡頭濾網
- 輕鬆清洗起泡頭濾網
- 二段式陶瓷閥芯
- ECO 節能手把

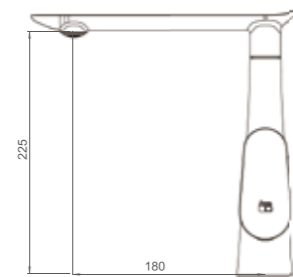

JUN 檯面無鉛龍頭

EA-193-GB 黑色烤漆 x 玫瑰金

NT\$ 17900

- 省水起泡頭濾網
- 輕鬆清洗起泡頭濾網
- 二段式陶瓷閥芯
- 高品質軟管握把
- 握把經隔熱處理避免燙傷
- 可活動及收納式軟管

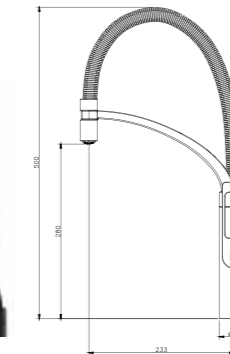

SHERLOCK 檯面無鉛龍頭

EA-071-GB 黑色 x 玫瑰金

NT\$ 17000

- 省水起泡頭濾網
- 輕鬆清洗起泡頭濾網
- 二段式陶瓷閥芯
- ECO 節能手把

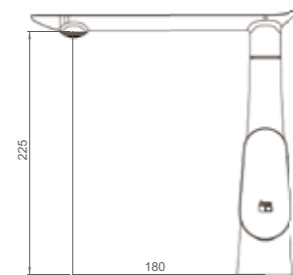

NEW





JUN 檯面無鉛龍頭

EA-168-N 絲光鍍銀

NT\$ 16500

- 省水起泡頭濾網
- 二段式陶瓷閥芯
- ECO 節能手把
- 高品質軟管握把
- 握把經隔熱處理避免燙傷
- 可活動及收納式軟管

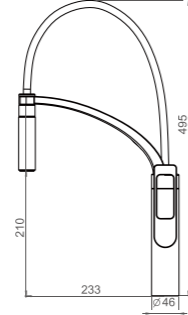

JUN 檯面無鉛龍頭

EA-314-GB 黑色烤漆 X 玫瑰金

NT\$ 17500

- 省水起泡頭濾網
- 二段式陶瓷閥芯
- ECO 節能手把
- 高品質軟管握把
- 握把經隔熱處理避免燙傷
- 可活動及收納式軟管

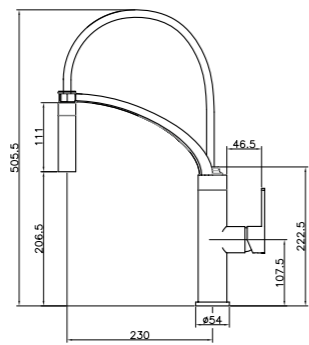

NEW

FLEAKER 檯面無鉛伸縮龍頭

EA-211-GB 黑色烤漆 X 玫瑰金

NT\$ 17200

EA-211-N 絲光鍍銀

NT\$ 16600

- 省水起泡頭濾網
- 二段式陶瓷閥芯
- ECO 節能手把
- 高品質下抽拉伸縮軟管握把
- 握把經隔熱處理避免燙傷

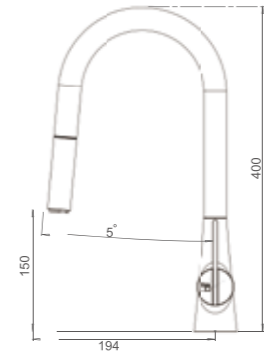

OPHIR 花灑 檯面無鉛伸縮龍頭

EA-353-B 黑色烤漆

NT\$ 16800

- 省水起泡頭濾網
- 二段式陶瓷閥芯
- 雙重噴頭花灑功能

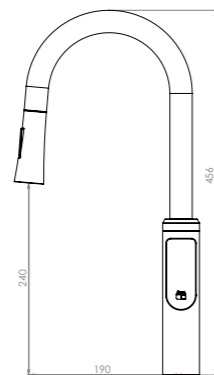

NEW

SHERLOCK 花灑 檯面無鉛伸縮龍頭

EA-072-N 絲光鍍銀

NT\$ 16500

- 省水起泡頭濾網
- 二段式陶瓷閥芯
- ECO 節能手把
- 雙重噴頭功能花灑

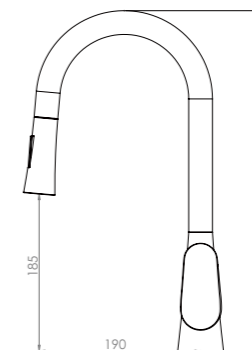



BIBER 浴室無鉛龍頭
EA-215-GW

NT\$ 15300

- 省水起泡頭濾網
- 單一把手設計
- 把手 白色陶瓷X玫瑰金
- 管身 白色烤漆X玫瑰金

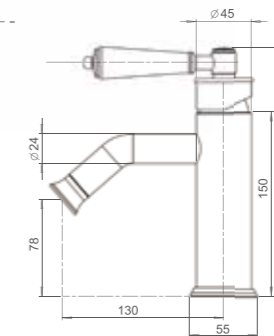

OPHIR 浴室無鉛龍頭
EA-021-CW 鍍鉻X白色烤漆

NT\$ 16600

- 省水起泡頭濾網
- 輕鬆清洗起泡頭濾網
- ECO 節能手把
- 德國紅點設計大獎 (Red Dot)

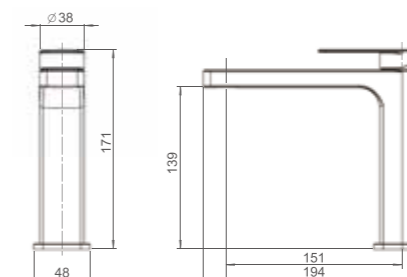

OPHIR 浴室無鉛感應式龍頭
EA-325-C 絲光鍍銀

NT\$ 18500

- 非接觸式，紅外線 IR 感應出水
- 更易省水，用水完畢即自動關水
- 省水起泡頭濾網
- 輕鬆清洗起泡頭濾網
- 單冷水 (不可調節水溫)
- 附電池 (CR123A 2顆)

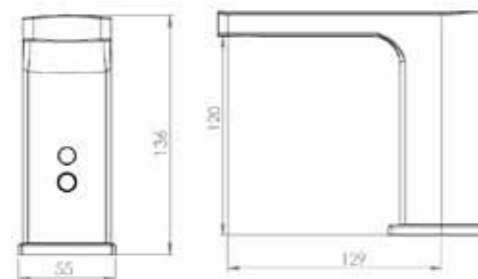

NEW

ANGO 浴室無鉛龍頭
EA-160-C 鍍鉻

NT\$ 12500

- 省水起泡頭濾網
- 輕鬆清洗起泡頭濾網
- 二段式陶瓷閥芯
- ECO 節能手把

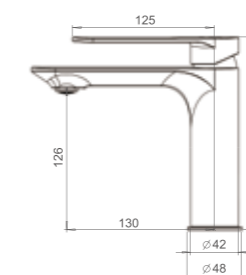

COR IR 浴室無鉛感應式龍頭
EA-327-B 黑色烤漆X白色

NT\$ 19200

- 材質可麗耐 (Corian®): 易清潔，耐髒污。
- 非接觸式，紅外線 IR 感應出水
- 更易省水，用水完畢即自動關水
- 省水起泡頭濾網
- 輕鬆清洗起泡頭濾網
- 單冷水 (不可調節水溫)
- 附電池 (CR123A 2顆)

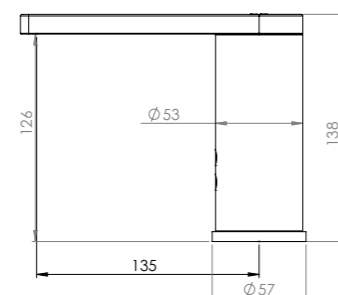

NEW

ANGO 沐浴龍頭
EA-320-C 鍍鉻

NT\$ 15200

- 省水起泡頭濾網
- 輕鬆清洗起泡頭
- 一手輕鬆調控
- 特殊閥心，輕鬆調溫
- 把手往上撥，上方蓮蓬頭出水
- 把手往下撥，下方出水口出水
- 附 ABS 蓮蓬頭
- 附 ABS 固定座
- 附 304 不鏽鋼 150CM 軟管
- 附高級止水彎頭

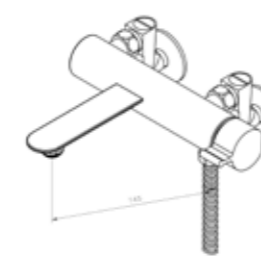

NEW



COR 浴室無鉛龍頭

EA-225-N 絲光鍍銀 NT\$ 15800

EA-227-N 增高-絲光鍍銀 NT\$ 17400

- 出水口方式詳見頁 16 右下
- 材質可麗耐 (Corian®)：易清潔，較不易卡髒污
- 普通高度 / 增高 二種樣式

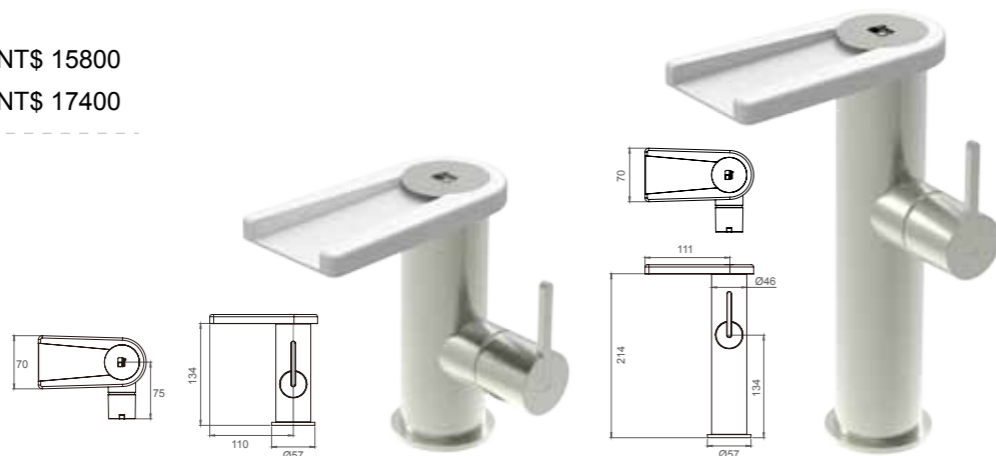

INKY 浴室無鉛龍頭

EA-002-B 黑色烤漆 NT\$ 14700

EA-002-C 鍍鉻 NT\$ 13900

EA-099-C 增高-鍍鉻 NT\$ 14700

- 彷彿從竹子中流出水來
- ECO 節能手把
- 普通高度 / 增高 二種樣式

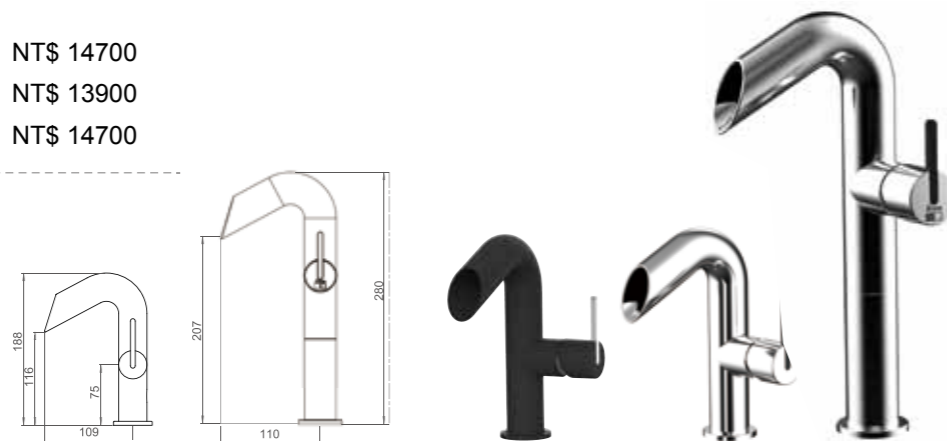

ZENAWA 浴室無鉛龍頭

EA-025-N 鍍銀 NT\$ 14700

- 彷彿從竹子中流出水來

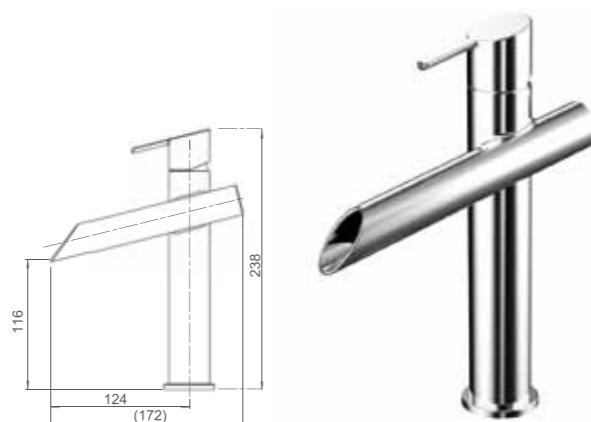

Declaration of brass composition
relative to Lead Free

Awa Faucet Ltd products are made of
“Lead Free” (<0.25% of Pb) compliant materials
when in contact with water based on CNS 8088

歐瓦所製造的無鉛龍頭符合水龍頭國家標準CNS8088，其原料鉛含量低於0.25%。



— 歐瓦龍頭採用以下高級配件 —

無鉛三角凡爾



銅製P管



銅製落水頭





ED-KA4905-B NT\$ 16300

- PVD 花灑檯面龍頭
- 黑色 + 玫瑰金
- 附 304 不鏽鋼加長型三角凡而
- 日本陶瓷閥芯



ED-K11313BK NT\$ 11600

- 三用檯面龍頭 黑色
- 附銅製加長型三角凡而



ED-F10753BK NT\$ 9000

- 臉盆龍頭 黑色
- 附 銅製三角凡而
- 附 銅製按壓式落水頭
- 附 銅製 P 管



ED-H20753BK NT\$ 11400

- 沐浴龍頭組 黑色
- 附 ABS 蓮蓬頭
- 青銅固定座
- 150CM 軟管
- 高級止水彎頭



ED-KA4308-B NT\$ 14300

- PVD 伸縮花灑檯面龍頭
- 黑色 + 玫瑰金
- 附 304 不鏽鋼加長型三角凡而
- 日本陶瓷閥芯



ED-K11311BK NT\$ 9900

- 伸縮檯面龍頭 黑色
- 附銅製加長型三角凡而

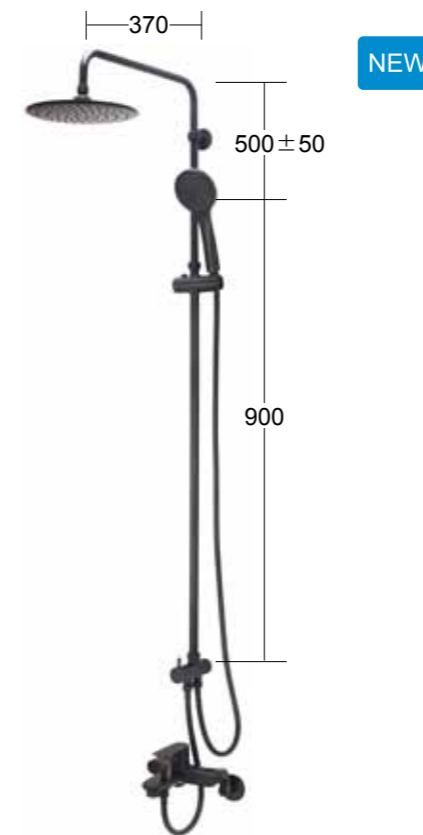

ED-R20753-076BK NT\$ 21600

- 淋浴柱 黑色
- 附 ABS 蓮蓬頭
- ABS 可調式固定座
- 150CM 軟管
- 高級止水彎頭



ED-T22462BK NT\$ 5600

- 滑桿 黑色
- 青銅



ED-KA4903-B NT\$ 12200

- PVD 花灑檯面龍頭
- 黑色 + 玫瑰金
- 附 304 不鏽鋼加長型三角凡而
- 日本陶瓷閥芯



ED-K11618-07BK NT\$ 7600

- 檯面龍頭 黑色
- 附銅製加長型三角凡而



ED-KS83509 NT\$ 11000

- 304 不鏽鋼無鉛龍頭
- 三用檯面龍頭
- 附 304 不鏽鋼加長型三角凡而



ED-KS83503 NT\$ 10800

- 304 不鏽鋼無鉛龍頭
- 三用檯面龍頭
- 附 304 不鏽鋼加長型三角凡而

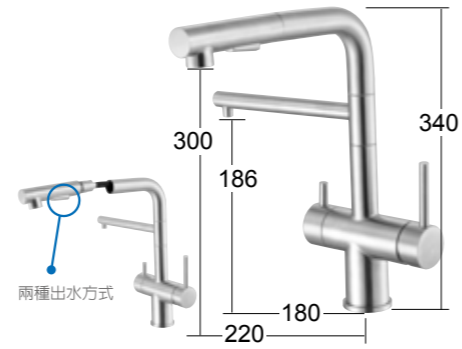

ED-KS4022LT NT\$ 16600

- 304 不鏽鋼無鉛龍頭
- 三用伸縮花灑檯面龍頭
- 附 304 不鏽鋼加長型三角凡而
- 日本陶瓷閥芯



ED-K11326 NT\$ 8650

- 伸縮花灑檯面龍頭
- 附銅製加長型三角凡而



ED-K11327 NT\$ 8650

- 伸縮花灑檯面龍頭
- 附銅製加長型三角凡而

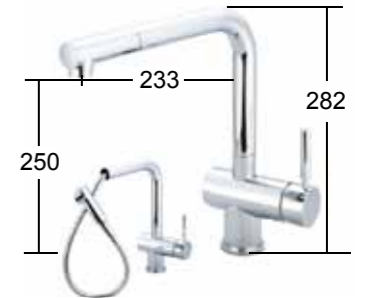

ED-11321 NT\$ 8400

- 伸縮檯面龍頭
- 附銅製加長型三角凡而



ED-KS83508 NT\$ 9900

- 304 不鏽鋼無鉛龍頭
- 伸縮花灑檯面龍頭
- 附 304 不鏽鋼加長型三角凡而



ED-KS4020 NT\$ 10900

- 304 不鏽鋼無鉛龍頭
- 流線型伸縮花灑檯面龍頭
- 附 304 不鏽鋼加長型三角凡而
- 日本陶瓷閥芯



ED-K11314 NT\$ 9900

- 三用檯面龍頭
- 附銅製加長型三角凡而



ED-K11311 NT\$ 7400

- 伸縮檯面龍頭
- 附銅製加長型三角凡而



ED-KS83501 NT\$ 5300

- 304 不鏽鋼無鉛龍頭
- 檯面龍頭
- 附 304 不鏽鋼加長型三角凡而



ED-KS83502 NT\$ 6400

- 304 不鏽鋼無鉛龍頭
- 檯面龍頭
- 附 304 不鏽鋼加長型三角凡而

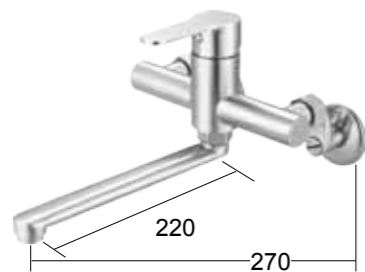

ED-KS83506 NT\$ 6400

- 304 不鏽鋼無鉛龍頭
- 壁式龍頭
- 附 304 不鏽鋼止水彎頭



ED-KS83507 NT\$ 5600

- 304 不鏽鋼無鉛龍頭
- 檯面龍頭
- 附 304 不鏽鋼加長型三角凡而



ED-10368 NT\$ 5400

- 檯面龍頭
- 附銅製加長型三角凡而



ED-K10160 NT\$ 6000

- 檯面龍頭
- 附銅製加長型三角凡而



ED-FS20171 NT\$ 7500

- 304 不鏽鋼無鉛龍頭
- 臉盆龍頭
- 附 304 不鏽鋼加長型三角凡而
- 附銅製按壓式落水頭
- 附銅製 P 管
- 日本陶瓷閥芯



ED-HS4018-01 NT\$ 12200

- 304 不鏽鋼無鉛龍頭
- 沐浴龍頭組
- 304 不鏽鋼蓮蓬頭
- 附 304 不鏽鋼固定座
- 附 304 不鏽鋼 150CM 軟管
- 附 304 大流量止水彎頭
- 日本陶瓷閥芯



ED-FS18761 NT\$ 6800

- 304 不鏽鋼無鉛龍頭
- 臉盆龍頭
- 附 304 不鏽鋼三角凡而
- 附銅製按壓式落水頭
- 附銅製 P 管

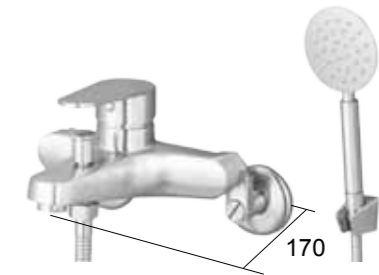

ED-HS28761 NT\$ 8400

- 304 不鏽鋼無鉛龍頭
- 沐浴龍頭組
- 附 304 不鏽鋼蓮蓬頭
- 附 304 不鏽鋼固定座
- 附 304 不鏽鋼 150CM 軟管
- 附 304 不鏽鋼止水彎頭



ED-FS20173A NT\$ 7500

- 304 不鏽鋼無鉛龍頭
- 臉盆龍頭
- 附 304 不鏽鋼加長型三角凡而
- 附銅製按壓式落水頭
- 附銅製 P 管
- 日本陶瓷閥芯



ED-HS4017A-01 NT\$ 13800

- 304 不鏽鋼無鉛龍頭
- 沐浴龍頭組
- 304 不鏽鋼蓮蓬頭
- 附 304 不鏽鋼固定座
- 附 304 不鏽鋼 150CM 軟管
- 附 304 大流量止水彎頭
- 日本陶瓷閥芯



ED-FS18763 NT\$ 6200

- 304 不鏽鋼無鉛龍頭
- 臉盆龍頭
- 附 304 不鏽鋼三角凡而
- 附銅製按壓式落水頭
- 附銅製 P 管

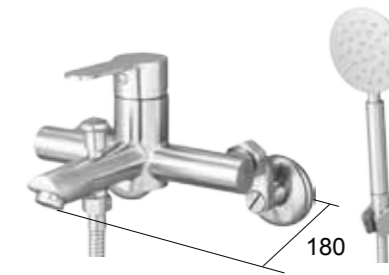

ED-HS28763 NT\$ 7300

- 304 不鏽鋼無鉛龍頭
- 沐浴龍頭組
- 附 304 不鏽鋼蓮蓬頭
- 附 304 不鏽鋼固定座
- 附 304 不鏽鋼 150CM 軟管
- 附 304 不鏽鋼止水彎頭



ED-FS18766 NT\$ 8600

- 304 不鏽鋼無鉛龍頭
- 臉盆龍頭
- 附 304 不鏽鋼蓮蓬頭
- 附 304 不鏽鋼固定座
- 附 304 不鏽鋼 150CM 軟管
- 附 304 不鏽鋼三角凡而
- 附銅製按壓式落水頭
- 附銅製 P 管



ED-HS28765 NT\$ 7300

- 304 不鏽鋼無鉛龍頭
 - 沐浴龍頭組
 - 附 304 不鏽鋼蓮蓬頭
 - 附 304 不鏽鋼固定座
 - 附 304 不鏽鋼 150CM 軟管
 - 附 304 不鏽鋼止水彎頭
- 產品特色**
- 水龍頭出水管向左撥，上方蓮蓬頭出水，不佔淋浴空間。
 - 出水管置於中間，下方出水管出水。



ED-VS8655 NT\$ 2900

- 304 不鏽鋼
- 沖洗器
- 附 304 不鏽鋼固定座
- 附 304 不鏽鋼 150CM 軟管
- 附 304 不鏽鋼控制閥進水三通



ED-VS8655A NT\$ 2600

- 304 不鏽鋼
- 沖洗器
- 附 304 不鏽鋼固定座
- 附 304 不鏽鋼 150CM 軟管
- 附 304 不鏽鋼三角凡而



ED-VS8651 NT\$ 2200

- 304 不鏽鋼
- 沖洗器
- 附 304 不鏽鋼固定座
- 附 304 不鏽鋼 150CM 軟管
- 附 304 不鏽鋼控制閥進水三通



ED-VS8651A NT\$ 1900

- 304 不鏽鋼
- 沖洗器
- 附 304 不鏽鋼固定座
- 附 304 不鏽鋼 150CM 軟管
- 附 304 不鏽鋼三角凡而



ED-F10753 NT\$ 6900

- 臉盆龍頭
- 附銅製三角凡而
- 附銅製按壓式落水頭
- 附銅製 P 管



ED-H20753A NT\$ 8250

- 沐浴龍頭組
- 附 ABS 蓮蓬頭
- 附青銅固定座
- 附 304 不鏽鋼 150CM 軟管
- 附高級止水彎頭

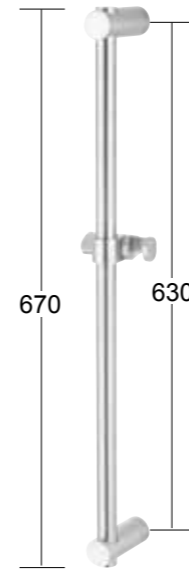

ED-TS01
NT\$ 4200

- 高級活動滑桿
- 304 不鏽鋼

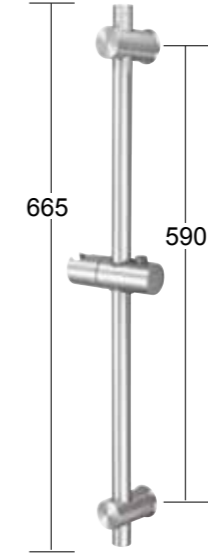

ED-T6507
NT\$ 3500

- 滑桿
- 304 不鏽鋼

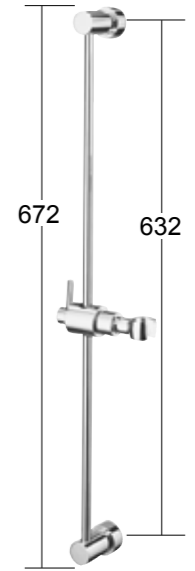

NEW

ED-T22462
NT\$ 3950

- 滑桿
- 青銅



ED-F11613R NT\$ 5500

- 臉盆龍頭
- 附銅製三角凡而
- 附銅製按壓式落水頭
- 附銅製 P 管

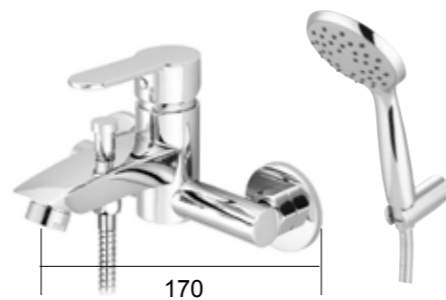

ED-H22613RB NT\$ 7500

- 沐浴龍頭組
- 附 ABS 蓮蓬頭
- 附青銅固定座
- 附 304 不鏽鋼 150CM 軟管
- 附高級止水彎頭



ED-RS70016-01 NT\$ 23000

- 304 不鏽鋼無鉛龍頭
- 高級淋浴柱
- 直桿高度：78CM~145CM
- 附 304 不鏽鋼蓮蓬頭
- 304 不鏽鋼可調式固定座
- 附 304 不鏽鋼 150CM 軟管
- 附 304 大流量止水彎頭
- 日本陶瓷閥芯



NEW

ED-RS28501 NT\$ 16800

- 304 不鏽鋼無鉛龍頭
- 淋浴柱
- 直桿高度：120CM ~ 145CM
- 附 304 不鏽鋼蓮蓬頭
- 附 304 不鏽鋼固定座
- 附 304 不鏽鋼 150CM 軟管
- 附 304 不鏽鋼止水彎頭



NEW

ED-R28126-076 NT\$ 17800

- 淋浴柱
- 直桿高度：115CM ~ 145CM
- 附 ABS 蓮蓬頭
- ABS 可調式固定座
- 304 不鏽鋼 150CM 軟管
- 高級止水彎頭



NEW

ED-F18116 NT\$ 6950

- 臉盆龍頭
- 附銅製三角凡而
- 附銅製按壓式落水頭
- 附銅製 P 管



NEW

ED-H28126 NT\$ 8950

- 沐浴龍頭組
- 附 ABS 蓮蓬頭
- 附青銅固定座
- 附 304 不鏽鋼 150CM 軟管
- 附高級止水彎頭



NEW

DD9487

NT\$ 26500

- 手工小 R 角方槽
- 髮絲紋
- STAINLESS SINK
- 人造石下嵌、天然石 / 美耐板上裝、不鏽鋼檯面平接

材質	304 STAINLESS STEEL
外徑 OUTSIDE DIA.	870X460X220MM
內徑 INSIDE DIA.	830X420X220MM
厚度 THICKNESS	1.1MM
適用桶身	90CM 以上
底部貼防潮消音墊、無溢水孔	
ST 後置型大提籠、ST 半邊籃、ST 瀝水盆	



NEW

DD9477

NT\$ 22300

- 手工小 R 角方槽
- 髮絲紋
- STAINLESS SINK
- 人造石下嵌、天然石 / 美耐板上裝、不鏽鋼檯面平接

材質	304 STAINLESS STEEL
外徑 OUTSIDE DIA.	770X460X220MM
內徑 INSIDE DIA.	730X420X220MM
厚度 THICKNESS	1.1MM
適用桶身	80CM 以上
底部貼防潮消音墊、無溢水孔	
ST 後置型大提籠、ST 瀝水盆	



ST3052

NT\$ 3900

- 全展 W316 X D506MM
- 收納 Ø53 X D506MM
- 適用四方型水槽

ST3052L

NT\$ 4350

- 全展 W316 X D546MM
- 收納 Ø53 X D546MM
- 適用海灣型水槽



- 滴水捲簾
- ROLLABLE DISHES HOLDER
- 304 STAINLESS STEEL
- 食用級耐熱矽膠
- 20 支 304 不鏽鋼扁條



NEW

DD9467

NT\$ 19800

- 手工小 R 角方槽
- 髮絲紋
- STAINLESS SINK
- 人造石下嵌、天然石 / 美耐板上裝、不鏽鋼檯面平接

材質	304 STAINLESS STEEL
外徑 OUTSIDE DIA.	670X460X220MM
內徑 INSIDE DIA.	630X420X220MM
厚度 THICKNESS	1.1MM
適用桶身	70CM 以上
底部貼防潮消音墊、無溢水孔	
ST 後置型大提籠、ST 瀝水盆	



NEW

DD9456

NT\$ 17900

- 手工小 R 角方槽
- 髮絲紋
- STAINLESS SINK
- 人造石下嵌、天然石 / 美耐板上裝、不鏽鋼檯面平接

材質	304 STAINLESS STEEL
外徑 OUTSIDE DIA.	560X460X220MM
內徑 INSIDE DIA.	520X420X220MM
厚度 THICKNESS	1.1MM
適用桶身	60CM 以上
底部貼防潮消音墊、無溢水孔	
ST 後置型中提籠、方槽用 ST 半邊籃	



DD0168FN

NT\$ 19500

- 大愛琴海
- 柔絲面
- STAINLESS SINK
- 人造石下嵌、天然石 / 美耐板上裝、不鏽鋼檯面平接

材質	STAINLESS STEEL	SUS 304 柔絲面
外徑 OUTSIDE DIA.	820X520X230MM	
內徑 INSIDE DIA.	760X460X215MM	
厚度 THICKNESS	1.0MM	
適用桶身	85CM 以上	
底部貼防潮消音墊、無溢水孔		
ST 後置型大提籠、ST 掛籃、ST 半邊籃		



DD0101B

NT\$ 16200

- 愛琴海單槽
- 柔絲面
- STAINLESS SINK
- 人造石下嵌、天然石 / 美耐板上裝、不鏽鋼檯面平接

材質	STAINLESS STEEL	SUS 304 柔絲面
外徑 OUTSIDE DIA.	700X510X230MM	
內徑 INSIDE DIA.	650X460X215MM	
厚度 THICKNESS	0.7MM	
適用桶身	75CM 以上	
底部貼防潮消音墊、無溢水孔		
ST 後置型大提籠、ST 半邊籃、ST 多功能掛籃		



NEW

DD0166

NT\$ 21600

- 歐式方形大單槽
- 柔絲面
- STAINLESS SINK
- 人造石下嵌、天然石 / 美耐板上裝、不鏽鋼檯面平接

材質	304 STAINLESS STEEL
外徑 OUTSIDE DIA.	800X520X230MM
內徑 INSIDE DIA.	735X460X225MM
厚度 THICKNESS	1.0MM
適用桶身	80CM 以上
底部貼防潮消音墊、無溢水孔	
ST 後置型大提籠、ST 半邊籃、ST 掛籃	



DD0167

NT\$ 16900

- 歐式全四方單槽
- 柔絲面
- STAINLESS SINK
- 人造石下嵌、天然石 / 美耐板上裝、不鏽鋼檯面平接

材質	STAINLESS STEEL	SUS 304 柔絲面
外徑 OUTSIDE DIA.	710X450X225MM	
內徑 INSIDE DIA.	680X420X220MM	
厚度 THICKNESS	1.0MM	
適用桶身	75CM 以上	
底部貼防潮消音墊、無溢水孔		
ST 後置型大提籠、ST 掛籃		



NEW

DD0502

NT\$ 9800

- 大原槽
- 毛絲面
- STAINLESS SINK
- 人造石下嵌、不鏽鋼檯面平接

材質	304 STAINLESS STEEL
內徑 INSIDE DIA.	740X420X200MM
厚度 THICKNESS	0.7MM
適用桶身	80CM 以上
底部貼防潮消音墊、有溢水孔	
ST 後置型中提籠	



NEW

DD0505

NT\$ 6200

- 大原槽
- 毛絲面
- STAINLESS SINK
- 人造石下嵌、不鏽鋼檯面平接

材質	304 STAINLESS STEEL
內徑 INSIDE DIA.	560X410X200MM
厚度 THICKNESS	0.6MM
適用桶身	65CM 以上
底部貼防潮消音墊、有溢水孔	
ST 後置型中提籠	



DD9449-01

NT\$ 14900

- 手工小 R 角方槽
- 髮絲紋
- STAINLESS SINK
- 人造石下嵌、天然石 / 美耐板上裝、不鏽鋼檯面平接

材質	STAINLESS STEEL	304 髮絲紋
外徑 OUTSIDE DIA.	490X460X220MM	
內徑 INSIDE DIA.	450X420X220MM	
厚度 THICKNESS	1.1MM	
適用桶身	55CM 以上	
ST 後置型中提籠、無溢水孔、底部貼防潮消音墊		



DD9434

NT\$ 12100

- 手工小 R 角方槽
- 髮絲紋
- STAINLESS SINK
- 人造石下嵌、天然石 / 美耐板上裝、不鏽鋼檯面平接

材質	STAINLESS STEEL	304 髮絲紋
外徑 OUTSIDE DIA.	340X460X220MM	
內徑 INSIDE DIA.	300X420X220MM	
厚度 THICKNESS	1.1MM	
適用桶身	40CM 以上	
ST 後置型小提籠、無溢水孔、底部貼防潮消音墊		



DD0301-01

NT\$ 6600

- 大橢圓
- 毛絲面
- STAINLESS SINK
- 人造石下嵌、天然石 / 美耐板上裝、不鏽鋼檯面平接

材質	STAINLESS STEEL	304 毛絲面
外徑 OUTSIDE DIA.	620X480X205MM	
內徑 INSIDE DIA.	560X410X200MM	
厚度 THICKNESS	0.6MM	
適用桶身	65CM 以上	
ST 後置型中提籠、有溢水孔、底部貼防潮消音墊		



DD0006F

NT\$ 7600

- 圓形吧檯槽
- 毛絲面
- ROUND BAR SINK
- 人造石下嵌、天然石 / 美耐板上裝、不鏽鋼檯面平接

材質	STAINLESS STEEL	304 毛絲面
外徑 OUTSIDE DIA.	435X435X185MM	
內徑 INSIDE DIA.	380X380X180MM	
厚度 THICKNESS	0.7MM	
適用桶身	50CM 以上	
ST 後置型小提籠、無溢水孔、附落水頭		

環保防蟑防臭新型專利 不鏽鋼後置型大提籠



◎ 實例圖 適用 18 公分提籠孔



◎ 洗碗機專用接法示意圖

環保防蟑防臭新型專利 不鏽鋼後置型中提籠



◎ 實例圖 適用 14.5 公分提籠孔

◎ 櫃體安裝示意圖

地排式



地排式



產品特色

後置式設計：

傳統櫥櫃內空間常因排水管置於中間貫穿上下，造成空間難以利用，本公司研發的新型提籠組獨特後置式設計將出口轉向後方，櫥櫃內空間不再因排水管而有所阻礙，無論是搭配櫥下拉籃或是抽屜、隔板都更為方便。

S 彎管防蟑防臭：

下方的 S 彎管設計，利用水將蟑螂及排水管臭味阻絕於外，達到防蟑防臭的效果。

超淺提籠高度：

將水槽下提籠高度由傳統約 30 公分減淺至 15 公分，櫥下空間自由利用。

功能齊全：

沉水彎處預先留有洗碗機排水孔及汙物清潔孔，毋須另行加裝三通配件，櫥下空間更簡潔。



◎ 防蟑防臭示意圖



ED-VS3007 NT\$ 700

- 蓮蓬頭
- 304 不鏽鋼



ED-VS24089 NT\$ 950

- 蓮蓬頭
- 304 不鏽鋼



ED-VS10S NT\$ 500

- 固定座
- 304 不鏽鋼



ED-V6025CP NT\$ 650

- 蓮蓬頭
- ABS



ED-V24137 NT\$ 550

- 蓮蓬頭
- ABS



ED-V32013 NT\$ 1200

- 三段式蓮蓬頭
- ABS 絲光



ED-VS04055A NT\$ 580

- 加密軟管
- 304 不鏽鋼
- 150CM



ED-V04055BK NT\$ 850

- 黑色軟管
- 150CM



ED-V24088BK NT\$ 650

- 蓮蓬頭
- ABS
- 黑色



ED-VS992B NT\$ 700

- 加長型三角凡而
- 304 不鏽鋼



ED-VY33019 NT\$ 760

- 三角凡而
- 銅



ED-VS8650H NT\$ 1800

- 304 不鏽鋼
- 沖洗器
- 附 304 不鏽鋼固定座
- 附 304 不鏽鋼 150CM 加密軟管
- 附 304 不鏽鋼加長型三角凡而



ED-2013N NT\$ 950

- LED 紅外線生物光能蓮蓬頭
- W80 X H221MM
- ABS/PC

水龍頭打開後，蓮蓬頭裡面的燈光將隨之發亮。



ED-2040N NT\$ 950

- LED 溫顯炫光蓮蓬頭
- W80 X H221MM
- ABS/PC

水龍頭打開後，蓮蓬頭裡面的燈光將隨之發亮。
LED 色彩變化是跟著溫度高低而變化
冷水時呈現白色 (35°C 以下)、
溫水時呈現藍色 (36-38°C)、
增溫時呈現紫色 (38-40°C)、
熱水時呈現紅色 (40°C 以上)、
過熱水 (45°C 以上) 白加紅色一起閃爍，具警示作用。



M-304 NT\$ 1900

- 鑲雕防霧鏡
- MIRROR
- W450 X H600MM



M-193 NT\$ 2800

- 雙層鑲雕防霧鏡
- MIRROR
- W700 X H500MM



2600-2 掛桿頭 NT\$ 900 / 一對
2600M (中通) NT\$ 450 / 一個

- 掛桿固定座
- HOLDER
- 303 STAINLESS STEEL 不鏽鋼
- 303 不鏽鋼鏡面拋光
- φ 25 X D62MM



2600 系列 (5 分管)

2645C 45CM NT\$1100
2660C 60CM NT\$1150
2675C 75CM NT\$1200
2690C 90CM NT\$1300

- 單桿毛巾掛桿組
- 303 不鏽鋼鏡面拋光掛桿固定座 +304 不鏽鋼掛桿
- TOWEL BAR
- 303 STAINLESS STEEL HOLDER
- 304 STAINLESS STEEL TUBE
- 掛桿固定座 Ø25 X D62MM(內距 40MM)



ST2168 NT\$ 900

- 毛巾架
- TOWEL SHELF
- 304 STAINLESS STEEL
- W660 X D98 X H60MM



9000 系列 (1"圓管)

9260C 60CM NT\$ 1300
9275C 75CM NT\$ 1400
9290C 90CM NT\$ 1500

- 單桿毛巾掛桿組
- 青銅掛桿固定座 + #304 不鏽鋼掛桿
- TOWEL BAR (HOLDER+TUBE)
- #304 STAINLESS STEEL TUBE
- 1"圓管
- 掛桿頭 φ 65X90MM (內距62MM)



C2660BK 60CM NT\$ 1500
C2675BK 75CM NT\$ 1600

- 單桿毛巾掛桿組
- 黑色 BLACK
- 303 不鏽鋼掛桿固定座 + 304 不鏽鋼掛桿
- 掛桿固定座 Ø25 X D62MM(內距 40MM)



ST2169S NT\$ 650

- W480 X D97 X H30MM

ST2169L NT\$ 750

- W630 X D97 X H30MM
- 毛巾架
- TOWEL SHELF
- 304 STAINLESS STEEL



ST2269L-1 NT\$ 2150

- 毛巾架
- DOUBLE TOWEL BAR
- 304 STAINLESS STEEL
- W666 X D152 X H212MM

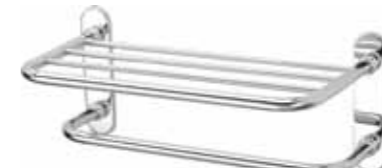

ST2269L-2 NT\$ 2750

- 毛巾置衣架
- TOWEL & CLOTHES SHELF
- 304 STAINLESS STEEL
- W666 X D250 X H212MM



ST2269L-3 NT\$ 3500

- 毛巾置衣架
- TOWEL & CLOTHES SHELF
- 304 STAINLESS STEEL
- W666 X D250 X H273MM

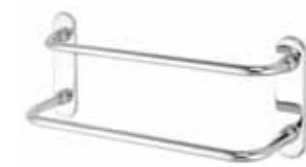

ST2269S-1 NT\$ 1950

- 毛巾架
- DOUBLE TOWEL BAR
- 304 STAINLESS STEEL
- W510 X D152 X H212MM



ST2269S-2 NT\$ 2600

- 毛巾置衣架
- TOWEL & CLOTHES SHELF
- 304 STAINLESS STEEL
- W510 X D250 X H212MM

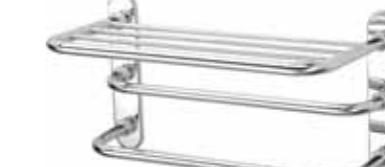

ST2269S-3 NT\$ 3300

- 毛巾置衣架
- TOWEL & CLOTHES SHELF
- 304 STAINLESS STEEL
- W510 X D250 X H273MM



2312-2 不鏽鋼色 120CM NT\$ 2850



2312 不鏽鋼色 120CM NT\$1950



2360-2 不鏽鋼色 60CM NT\$ 1700

2375-2 不鏽鋼色 75CM NT\$ 1800

2390-2 不鏽鋼色 90CM NT\$ 2000

- 雙桿毛巾掛桿組 4 分管
- 青銅掛桿固定座+#304不鏽鋼掛桿
- TWIN TOWEL BAR
- #304 STAINLESS STEEL TUBE
- 掛桿固定座 φ 38 X D116MM (內距45MM/內桿至外桿距離32MM)(4分管)



2360 不鏽鋼色 60CM NT\$1200

2375 不鏽鋼色 75CM NT\$1250

2390 不鏽鋼色 90CM NT\$1350

- 單桿毛巾掛桿組 4 分管
- 青銅掛桿固定座+#304不鏽鋼掛桿
- TOWEL BAR
- #304 STAINLESS STEEL TUBE
- 掛桿固定座 φ 38 X D85MM (內距60MM)(4分管)



ST2368 NT\$ 1700

- 置衣架
- CLOTHES SHELF
- 304 STAINLESS STEEL
- W660 X D250 X H60MM



ST2369S NT\$ 1650

- W480 X D250 X H30MM(S)

ST2369L NT\$ 1700

- W630 X D250 X H30MM(L)

- 置衣架
- CLOTHES SHELF
- 304 STAINLESS STEEL

※ 出清商品，依現有庫存售完為止，恕不再另行公告通知



9005C 不鏽鋼色 NT\$ 780

- 玻璃牙刷杯架
- TOOTHPASTE BRUSH & TUMBLER HOLDER(SINGLE)
- W75 X D125MM



2005GC NT\$ 90

- 玻璃牙刷杯
- TOOTH-BRUSH CUP
- GLASS



2006GC NT\$ 120

- 玻璃皂盤
- SOAP DISH
- GLASS



3501 NT\$ 550

- 毛巾環
- TOWEL HOLDER
- ACRYLIC HOLDER
- W200 X D80MM



ST1001 NT\$ 1350

- 絲光 牙刷杯架
- 304 不鏽鋼絲光
- 附霧面玻璃杯 GLASS CUP
- TUMBLER CUP WITH HOLDER
- 304 STAINLESS STEEL
- W120 X D90 X H96MM



2005BC NT\$ 580

- 附玻璃杯 GLASS CUP

2005BF NT\$ 600

- 附壓克力杯 ACRYLIC CUP
- 牙刷杯架
- TUMBLER CUP WITH BRASS HOLDER
- CHROME PLATING 不鏽鋼色
- W70 X D115 X H110MM
- 圓內徑 60MM



ST1003 NT\$ 1350

- 絲光 香皂盤架
- 304 不鏽鋼絲光
- 附霧面玻璃皂盤 GLASS SOAP
- SOAP DISH WITH HOLDER
- 304 STAINLESS STEEL
- W140 X D110 X H54MM



3505 NT\$ 550

- 盥洗杯組
- TOOTHBRUSH HOLDER
- ABS 塑膠、ACRYLIC
- W120 X D105 X D119MM



3506 NT\$ 550

- 香皂盤組
- SOAP DISH & ACRYLIC HOLDER
- ABS 塑膠、ACRYLIC
- W140 X D115MM



2005C-1 NT\$ 680

- 玻璃牙刷牙膏單杯架
- SINGLE TOOTHPASTE-BRUSH & TUMBLER & GLASS CUP W/ACRYLIC HOLDER
- CHROME PLATING 不鏽鋼色
- 壓克力座 ACRYLIC HOLDER
- W160 X D112MM



2006BC NT\$ 600

- 附玻璃香皂盤 GLASS SOAP

2006BF NT\$ 630

- 附壓克力香皂盤 ACRYLIC CUP
- 香皂盤架
- SOAP DISH WITH BRASS HOLDER
- CHROME PLATING 不鏽鋼色
- W140 X D130 X H60MM



9006C 不鏽鋼色 NT\$ 780

- 玻璃香皂盤架
- SOAP DISH HOLDER(SINGLE)
- W140 X D145MM



3505A NT\$ 50

- 盥洗杯
- TOOTHBRUSH CUP
- ABS 塑膠
- W109 X D77 X H119MM



8003C NT\$ 450

- 捲筒衛生紙架 (毛巾架)
- PAPER ROLL HOLDER (TOWEL HOLDER)
- CHROME PLATING 不鏽鋼色
- W165 X D75 X H133MM



2005BD NT\$ 500

- 吹風機架(小)
- BLOWER HOLDER
- CHROME PLATING 不鏽鋼色
- 圓內徑60MM



ST1005 NT\$ 1350

- 絲光 捲筒衛生紙架
- 304 不鏽鋼絲光
- PAPER ROLL HOLDER WITH LID
- 304 STAINLESS STEEL
- W133 X D70 X H135MM



9009C 不鏽鋼色 NT\$ 750

- 單掛衣勾
- SINGLE ROBE HOOK
- W95 X D95MM



8001C NT\$ 450

- 毛巾環
- TOWEL RING
- CHROME PLATING 不鏽鋼色
- W158 X D178 X H203MM
- 圓內徑 135MM



STH3709LFG NT\$ 2800

- 鏡子平台架 附圍欄
- 附 STH3700-2 固定座 / 一對
- 10MM GLASS SHELF WITH STH3700-2 HOLDER
- 10MM OG 邊強化玻璃
- W600XD146MM



2303 NT\$ 780

- 捲筒衛生紙架
- PAPER ROLL HOLDER
- W175 X D80MM



ST2291 NT\$ 950

- 書報架
- 附5000SC-2掛架固定座 厚底
- MAGAZINE RACK ACRYLIC
- 304 STAINLESS STEEL
- W320 X D100 X H230MM



1010C NT\$ 480

- 浴巾環
- BIGGER TOWEL RING
- CHROME PLATING 不鏽鋼色
- W170 X D60 X H175MM
- 圓內徑 145MM



3509LFG NT\$ 2200

- 鏡子平台架 附圍欄
- 附 3500-2 固定座 / 一對
- 10MM GLASS SHELF WITH 3500-2 HOLDER
- 10MM OG 邊強化玻璃
- W600XD146MM



3307SCG NT\$ 650

- 鏡子平台架
- 附3300C 固定座一個
- 10MM GLASS SHELF WITH 3300C HOLDER
- 10MM OG 邊強化玻璃
- W300XD146MM



3312SCG NT\$ 1200

- W200 X D200MM

3312CG NT\$ 1350

- W310 X D310MM
- 轉角架 附圍欄
- 附 3300C-2 固定座 / 一對
- 8MM GLASS CORNER HOLDER WITH 3300C-2 HOLDER
- 8MM OG 邊強化玻璃

※ 出清商品，依現有庫存售完為止，恕不再另行公告通知



1008T-6 NT\$ 850

- 抽取式衛生紙盒-桌上型-霧白色
- FACIAL TISSUE BOX(ACRYLIC)
- ACRYLIC 壓克力
- W230 X D130 X H100MM



1008B-8 NT\$ 1200

- 平板式衛生紙盒-掛放兩用-白色
- TOILET BOX
- ACRYLIC 壓克力
- W250 X D200 X H120MM (厚度 5MM)



2003CL NT\$ 800

- 壁式紙巾架
- PAPER TOWEL HOLDER
- CHROME PLATING 不鏽鋼色
- BRASS 青銅材質
- W250 X D70 X H105MM
- 內徑 230MM



ST3038 NT\$ 550

- 砧板掛架
- 304 STAINLESS STEEL
- W410 X D110 X H350MM



ST3076 NT\$ 4900

- 水槽上方置物組
- 附插盤架、餐具桶
- 可另選購滴水盤3061-30 x 2
- SINK MULTI-PURPOSE RACK
- 304 STAINLESS STEEL
- W712 X D250 X H440MM (內徑W685 X H355MM)



ST3076S NT\$ 3250

- 水槽上方置物架
- 可另選購滴水盤3061-30 x 2
- SINK MULTI-PURPOSE RACK
- 304 STAINLESS STEEL
- W712 X D250 X H440MM (內徑W685 X H355MM)



ST3033DH NT\$ 3200

- 雙層轉角架
- 適合廚房用
- 附5000SC-2掛架固定座 厚底
- CORNER RACK DOUBLE
- 304 STAINLESS STEEL
- W320 X D320 X H340MM
- 內徑高度 190MM



ST3088C NT\$ 1350

- 單層紙巾架 活動式
- SINGLE ACTIVE TOWEL RACK
- 304 STAINLESS STEEL
- W280 X D165 X H290MM



ST3088CH NT\$ 1050

- 單層紙巾架(活動式)
- 附5000SC-2掛架固定座 厚底
- SINGLE ACTIVE TOWEL RACK
- 304 STAINLESS STEEL
- W280 X D135X H110MM



V1008LB NT\$ 3100

- 電子感應自動環保桶
- 白色
- ABS 上蓋、鍍鋅板桶身
- AUTO SENSITIVE DUSTBIN
- 容量：8L
- Ø236 X H344MM
- 附 3 號電池 X 2
- 內附塑膠桶 Ø 225 X H266MM



SA-05EF51-02 NT\$ 1500

- 四方錐形垃圾桶
- 430 不鏽鋼桶身 (厚度 0.4MM)
- 緩降腳踏式
- DUSTBIN
- 容量：5L
- W210 X D250 X H320MM
- 塑膠內桶
- W195 X D195 X H247MM



SA-0503 NT\$ 1400

- 直向長形垃圾桶
- 桶身：烤漆，蓋子：430 不鏽鋼 (厚度 0.4MM)
- 緩降腳踏式
- DUSTBIN
- 容量：5L
- W205 X D260 X H300MM
- 塑膠內桶 Ø200 x H240MM



ST3033D NT\$ 3200

- 雙層轉角架
- 適合廚房用
- CORNER RACK DOUBLE
- 304 STAINLESS STEEL
- W320 X D320 X H450MM
- 內徑高度 190MM



ST3088 NT\$ 3800

- 三層紙巾及調味架活動式
- PAPER TOWEL TRIPLE RACKS FOR REFRIGERATOR
- #304 STAINLESS STEEL
- W335 X D160 X H465MM
- 內徑高度 上層 118MM
- 內徑高度 下層 98MM



ST3088F NT\$ 3800

- 冰箱三層紙巾及調味架
- PAPER TOWEL TRIPLE RACKS FOR REFRIGERATOR
- #304 STAINLESS STEEL
- W335 X D155 X H445MM
- 內徑高度 上層 164MM
- 內徑高度 下層 95MM



9850-01 NT\$ 900

- 烘碗機網架 (80cm)
- 附小碗架 X1+ 筷子盒
- 304 STAINLESS STEEL
- W745 X D280 X H270MM
- 烘碗機內用小碗架
- 304 STAINLESS STEEL
- W285 X D130 X H75MM



ST3090 NT\$ 4100

- 吧台架
- BAR RACK
- 304 STAINLESS STEEL
- W950 X D300 X H380MM
- 高腳杯 入口徑 70MM



ST3090A NT\$ 4100

- 吧台架
- BAR RACK
- 304 STAINLESS STEEL
- W950 X D300 X H335MM
- 高腳杯 入口徑 70MM



ST3033S NT\$ 1800

- W225 X D225 X H280MM

ST3033 NT\$ 2300

- W320 X D320 X H280MM

- 轉角架-掛式
- CORNER RACK
- 304 STAINLESS STEEL



3012LC 不鏽鋼色 NT\$ 650

- 吊杯架 (大)
- HANGING CUP RACK L
- CHROME PLATING
- BRASS 青銅材質
- W360 X D60MM



ST3037 NT\$ 300

- 鍋蓋架
- 304 STAINLESS STEEL
- W95 X D87 X H280MM

9850-02 NT\$ 650

- 烘碗機網架 (80CM)
- 附 1003 ABS 筷子盒
- W745 X D280 X H270MM

※ 出清商品，依現有庫存售完為止，恕不再另行公告通知

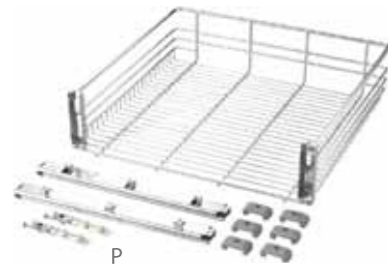

抽屜式三邊拉籃
 • DRAWER TYPE
 • P (鍍鉻) 三段式鋼珠滑軌



D5300-2
 • 前托架及卡夾頭
 • FRONT BRACKET WITH DOWEL



抽屜式拉籃
 • DRAWER TYPE

抽屜式三邊拉籃
SLIDING BASKET (DRAWER TYPE)

CABINET WIDTH 櫥櫃尺寸	ITEM NO.	DIM. WXD XH(MM) 拉籃尺寸
	304 STAINLESS STEEL+CHROME 不鏽鋼+鍍鉻	
400MM	ST5340P NT\$2900	320X483X140
450MM	ST5345P NT\$3000	370X483X140
500MM	ST5350P NT\$3200	420X483X140
720MM	ST5372P NT\$3600	640X483X140

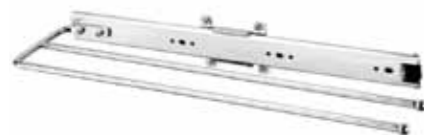

ST5218 NT\$ 950
 • 活動衣褲架
 • 304 STAINLESS STEEL
 • W450 X D110 X H40MM



開放式四邊拉籃
 • OPEN DOOR TYPE
 • PZ (鍍鉻) 三段式鋼珠滑軌



開放式四邊拉籃
SLIDING BASKET (OPEN DOOR TYPE)

CABINET WIDTH 櫥櫃尺寸	ITEM NO.	DIM. WXD XH(MM) 拉籃尺寸
	304 STAINLESS STEEL+CHROME 不鏽鋼+鍍鉻	
400MM	ST5440PZ NT\$2800	275X475X120
450MM	ST5445PZ NT\$2900	325X475X120
720MM	ST5472PZ NT\$3200	595X475X135
1000MM	ST5400PZ NT\$3900	875X475X135



5200C 不鏽鋼色 NT\$ 120 / 一對
 • 吊衣座 (一對)
 • DRESS-HANGER HOLDERS/PAIR
 • BRASS 青銅料



吊衣桿 亮麗不鏽鋼管
 DRESS-HANGER BAR
 304 STAINLESS STEEL

- ST5040R** NT\$ 250 W355XD15XH30MM
- ST5045R** NT\$ 270 W405XD15XH30MM
- ST5050R** NT\$ 300 W455XD15XH30MM
- ST5060R** NT\$ 330 W555XD15XH30MM
- ST5080R** NT\$ 360 W755XD15XH30MM
- ST5090R** NT\$ 390 W855XD15XH30MM
- ST5100R** NT\$ 420 W955XD15XH30MM
- ST5100T** NT\$ 450 W991XD15XH30MM

※ 出清商品，依現有庫存售完為止，恕不再另行公告通知